

An aerial, grayscale photograph of the Sydney region, showing the city's layout, surrounding hills, and the ocean. A vibrant green 3D city skyline is superimposed on the city area, with a single, tall, thin green vertical line extending from the top of the skyline to the top of the page.

CITY OF SYDNEY DECENTRALISED ENERGY MASTER PLAN RENEWABLE ENERGY

2012–2030

DECEMBER 2013

ACKNOWLEDGEMENTS

The City wishes to acknowledge and thank

- **Arup** for undertaking the renewable energy resource technical analysis required for the master plan.
- **Talent with Energy** for undertaking the Renewable Gases Supply Infrastructure and associated technologies, resources, economics and greenhouse gas emissions analysis required for the master plan.
- **The Allen Consulting Group** for undertaking the financial and economic analysis of renewable energy opportunities required for the master plan.

The renewable gases resource capacity requirement for the trigeneration demand was based on the City of Sydney Decentralised Energy Master Plan – Trigeneration undertaken by Kinesis.

Front cover designed by Kinesis.

This Master Plan has been prepared by the City of Sydney



Copyright 2013
December 2013



CONTENTS

FOREWORD	2
UNLOCKING THE MASTER PLAN	4
1. RENEWABLE ENERGY RESOURCES	12
2. RE-THINKING RENEWABLE ENERGY	19
3. RENEWABLE ENERGY FOR THE CITY OF SYDNEY	34
4. PERFORMANCE MEASURES	57
5. ENABLING THE MASTER PLAN	74
6. CASE STUDIES	83
TECHNICAL APPENDICES	140

FOREWORD

In 2008 the City of Sydney launched Sustainable Sydney 2030 and committed Sydney to becoming a green, global and connected city.

There are sufficient renewable energy resources within 250km of the city to meet the City of Sydney 30% renewable electricity target. Also, more than enough renewable gas feedstocks can be found within 250km of the city to provide 100% of the gas needed to supply the city's trigeneration network. Renewable electricity and renewable gases for the City's planned trigeneration network could supply 100% of buildings energy needs in the City of Sydney by 2030.

In Sustainable Sydney 2030, the City of Sydney set a target to reduce greenhouse gas emissions across the entire local government area (LGA) by 70% below 2006 levels by 2030.

Since 80% of the City of Sydney's LGA emissions come from centralised power generation, primarily coal, Sustainable Sydney 2030 also set a target for the City of Sydney LGA to have capacity to meet up to 100% of electricity demand by local generation by 2030. Of this local electricity demand, renewable electricity generation was expected to supply 30% and trigeneration 70% of the City's LGA by 2030.

Renewable energy is not new to Sydney. In 1796, Sydney became the first city in Australia to use renewable energy in the form of wind power to grind wheat for flour and windmills dotted the Sydney landscape, all the way from the Rocks to Parramatta up river. Windmills reigned in early colonial Sydney for more than 20 years until the introduction of coal-fired steam power.

This Renewable Energy Master Plan is based on renewable energy technologies that are currently available and commercially viable now or could become viable by 2030.

Currently, the prevailing renewable energy technologies in Australia are onshore wind and solar. Both these resources provide important contributions towards renewable energy, but largely only operate intermittently due to variations in climatic conditions and time of day.

Therefore, we need to include less intermittent or non intermittent renewable energy sources such as marine, geothermal, solar thermal and renewable gas resources in the renewable energy mix, if we are to avoid fossil fuel fired spinning reserve backing up intermittent renewable energy technologies. More recently, 'power to gas' technologies have also been deployed in Europe to capture surplus renewable electricity that would otherwise have to be switched off when



renewable electricity generation exceeds demand, particularly with a greater penetration of solar and wind. Using a combination of these renewable energy resources and conversion technologies would enable us to develop a renewable energy system that would genuinely replace fossil fuel base and peak load power generation.

Electricity should be generated close to where it is consumed for maximum efficiency. Local or decentralised renewable electricity generation avoids the high costs of transporting electricity from the country to the city. These transport costs currently make up more than half of the average electricity bill and due to rise to 60% of electricity bills by 2013/14. Furthermore, electricity generated from biomass or renewable feedstocks at remote sites will lose up to 80% of the renewable energy generated as waste heat into the atmosphere as well as losses in the electricity grid if utilised as renewable electricity rather than as renewable gas.

However, not all of the 30% renewable electricity target can be delivered inside the City's LGA. At least 12% of the renewable electricity required to meet demand in the City's LGA will need to be generated beyond the LGA in order to meet our renewable electricity generation target. That is why we have

established a proximity zone for sourcing renewable electricity within a nominal 250 kilometres of the city to avoid significant grid infrastructure connection costs and ongoing network charges that have recently driven up electricity bills. This becomes more cost effective where renewable electricity generation can displace coal fired electricity generation in the distribution network rather than the transmission network.

Renewable gases from residual waste and biomass are also an important component of our targets. Most renewable gases are located beyond the City of Sydney LGA where supply is abundant.

When treated and converted into a substitute natural gas, they can be injected into the natural gas pipeline for use on the City's planned trigeneration city-wide network. This will enable thermal energy as well as electrical energy to be recovered from renewable gas resources. This Master Plan details how 100% of the gas required to fuel a future trigeneration network 24 hours a day could be sourced from renewable sources located within 100–150km of the city.

Combining proposed efforts of the City's Renewable Energy and Trigeneration Master Plans and energy efficiency, the renewable electricity target of 30% and

greenhouse gas emissions reduction target of 70% below 2006 levels can not only be achieved by 2030 but potentially deliver 100% of the city's electricity, heating and cooling requirements from renewable energy by 2030.

Developing the renewable gas market in addition to other forms of renewable energy is key to this Master Plan. In conjunction with energy efficiency improvements through planning controls, building design and behavioural change, we are headed toward exceeding our target of reducing 2006 emissions by 70% by 2030.

Although beyond the scope of this Master plan, the renewable energy future for NSW and Australia also looks exciting. For the first time, 'power to gas' technologies can tap into the vast renewable energy resources in Australia, not only to make Australia renewable energy independent but also the potential to export renewable energy in the form of liquefied renewable gas to other parts of the world that could rival or exceed Australia's current fossil fuel exports which it could replace, thereby reducing global emissions rather than increasing them.

The implementation of renewable energy technologies cannot be delivered by the City alone, nor can the outcomes be realised in a short time frame. We recognise that the City of Sydney will need to cooperatively work with the private sector and other levels of government to deliver the full potential of this Master Plan. The City of Sydney is already working with the private sector on the development of renewable gases for precinct scale trigeneration in addition to currently installing the largest precinct scale building integrated solar PV program in Australia for its own buildings and operations which may well set the pathway for community and private sector renewable energy schemes in the future.

Allan Jones MBE
Chief Development Officer, Energy and Climate Change

Clover Moore
*Lord Mayor
City of Sydney*



UNLOCKING THE MASTER PLAN

The combination of this Master Plan, other Master Plans and the Federal Government's Renewable Energy Target could take the city off the coal-fired electricity grid by 2030.

- 1 By 2030, renewable electricity generation can provide 30% of electricity used in the City of Sydney.
- 2 Up to 18% of the City's electricity demand can be met from renewable electricity generation within the local government area.
- 3 At least 12% of the City's electricity demand can be met from renewable electricity generation within 250km of the local government area.
- 4 Renewable gases can replace 100% of the natural gas used to supply the City's planned trigeneration network.
- 5 Renewable energy can reduce greenhouse gas emissions across the entire local government area by 37.5% based on 2006 levels.
- 6 Renewable electricity and renewable gas can provide 100% of the city's electricity, heating and cooling requirements.

RENEWABLE ENERGY POTENTIAL

There are no new resources or technologies to be discovered or invented to tackle climate change or to meet the energy demands of a city or a nation from 100% non-intermittent renewable energy. The renewable energy resources and technologies to deliver both are available today and are being deployed in advanced economies around the world. The issue for Australia is not that these renewable energy resources and technologies cannot be deployed in Australia but that the current narrow view and mindset that renewable energy is only grid connected renewable electricity has to change if Australia is to become a renewable energy economy and potentially a major exporter of renewable energy to the world.

Unlike thermal or gas energy, electrical energy once generated has to be immediately consumed. Electricity storage devices can be deployed but these are limited and in the main the electricity grid is balanced by wasteful thermal power generation. The electricity grid is a problem for intermittent renewable electricity generation technologies such as solar and wind in that they currently require fossil fuel back up or spinning reserve at times of under-generation when demand exceeds renewable generation and switching off at times of over-generation when renewable generation exceeds demand.

And yet, Australia has vast renewable energy resources, particularly solar, wind and marine, capable of supplying Australia's energy needs many times over. How can the intermittency of renewable energy generation be overcome and how can Australia export its vast surplus renewable energy resources to the rest of the world?

In developing this Renewable Energy Master Plan detailed research was undertaken into world renewable energy best practice, the mix of renewable energy resources and technologies deployed and in particular, how other countries were overcoming the intermittency of renewable energy generation in their move towards a 100% renewable energy future, particularly in Europe, which is currently far ahead of Australia in terms of climate change and renewable energy targets and delivery. The European renewable energy model is also acting as a model for the US and Asian economies as countries seek to become energy independent and reduce their emissions.

To support the change required, Chapter 5 sets out the enabling actions necessary to deliver the full potential of this Master Plan and Chapter 6 sets out 45 case studies from around the world covering each and every type of renewable energy resource and technology referred to in this Master Plan to deliver a 100% renewable energy future.

RENEWABLE ELECTRICITY

Almost 90% of electricity currently used in the City of Sydney's Local Government Area (LGA) comes from coal fired power stations. These are responsible for 80% of greenhouse gas emissions from the City of Sydney LGA. Renewable energy technologies currently produce about 10% of Australia's electricity, largely from hydro and wind power, which is set to grow to 20% of Australia's electricity supply by 2020 under the current Renewable Energy Target.

This Renewable Energy Master Plan contributes toward the Sustainable Sydney 2030 target to reduce greenhouse gas emissions by 70% from 2006 levels by 2030. Since 80% of the City of Sydney's LGA emissions come from centralised power generation, primarily coal, Sustainable Sydney 2030 also set a target for the City of Sydney LGA to have capacity to meet up to 100% of electricity demand by local generation by 2030. Of this local electricity demand, renewable electricity generation was expected to supply 30% and trigeneration 70% of the City's LGA by 2030.

In developing the Renewable Energy Master Plan detailed research was undertaken into renewable energy resources inside and in proximity to the City's LGA, particularly how to overcome the intermittency of renewable electricity generation and the energy policies and technologies needed to deliver a 100% renewable energy system by 2030. This work established that using conventional renewable energy technologies within existing energy policy frameworks only 18% of the City's LGA electricity demand could be met by renewable electricity generation, principally solar, if all of the potential opportunities could be realised.

The difference between the renewable electricity target and what can be practically delivered on the ground in the City's LGA is principally due to the very high electric heating and cooling demands found in cities, against which conventional solar and wind can provide a relatively small and intermittent contribution to a city's electricity supply, and the very limited building surface space or land area that can accommodate conventional renewable energy technologies in cities. This demonstrates the inadequacies and distortions of nation-wide or state-wide renewable electricity assessments which are just not fine grained enough to identify the differences between city and country.

Therefore, in order to deliver the 30% renewable electricity target the City of Sydney would also have to source some of its renewable electricity from beyond the City's LGA.

The Renewable Energy Master Plan considered a wide range of renewable energy technologies prior to the selection of the renewable energy technologies and sources that are set out in the Master Plan. The longlist of renewable energy technologies and renewable feedstock resources considered and the reason why they were included or not included in this Master Plan are detailed in Technical Appendix 3.

The Renewable Energy Master Plan identifies a range of renewable energy resources, including solar, wind and geothermal. These technologies can be sufficiently harnessed to reach the target of 30% electricity sourced from renewable energy by 2030, including displaced grid electricity from renewable thermal energy systems such as solar thermal or hot water and direct use geothermal energy. This has an estimated capital cost of \$1.252 billion from 2012 to 2030 (\$340.7 million in 2012 dollars), generating or displacing 1,300 gigawatt hours (GWh) of electricity annually. This renewable electricity resource is greater than the

1,171GWh of renewable electricity needed to achieve the City's 30% renewable electricity target.

Solar electric photovoltaic (PV) panels, solar hot water systems, direct use geothermal hot water connected to a future trigeneration thermal reticulation network and wind turbines are currently the most commercially viable forms of renewable energy. However, the market is changing rapidly with innovation and economies of scale. For example, the price of solar panels is falling and in some locations solar generation can feasibly compete with the retail cost of coal-fired electricity from the grid, particularly at peak demand times in mid-afternoon and early evening.

Solar PV, solar thermal hot water, wind energy and geothermal direct use could produce the equivalent of up to 18% of the City's electricity demand from renewable energy generation inside the City of Sydney LGA if all of the available renewable energy resources are captured, with the majority coming from solar panel technologies installed on buildings. It is important to recognise that renewable resources not captured within the City of Sydney LGA will have to be sourced from beyond the LGA to meet the City's renewable electricity target.

A proximity principle for sourcing renewable electricity within a nominal 250 kilometres of the city was established to avoid significant grid infrastructure connection costs and ongoing network charges that have recently driven up electricity bills. This becomes more cost effective where renewable electricity generation can displace coal fired electricity generation in the distribution network rather than the transmission network.

Beyond the City of Sydney LGA there are a range of potential renewable electricity resources within a nominal distance of 250km. The most commercially viable is currently onshore wind turbines but other renewable electricity technologies such as offshore wind energy, geothermal electricity, concentrated solar PV, concentrated solar thermal, wave, tidal and new hydro could be cost competitive by 2030. Multiple renewable electricity resources within the 250km proximity zone were assessed to make up the shortfall required to meet the City's renewable electricity target.

The actual renewable electricity resources or mix of resources implemented by 2030 are likely to be different to this, particularly as the economics of particular technologies and the need to address intermittency with non intermittent renewable energy technologies will change between now and 2030.

In terms of economics, the City of Sydney's 30% renewable electricity target would be met if at least the central or medium uptake scenario as set out in Appendix 1 was adopted, providing the current 'Government Policy' scenario carbon price trajectory and electricity price impacts were maintained or increased. Under the medium uptake scenario the City's renewable electricity target would be delivered by the following mix of technologies by 2030:

- building integrated renewable energy within the City of Sydney LGA at a cost of \$716.7 million from 2012 to 2030 (\$210.7 million in 2012 dollars); and
- renewable energy resources from beyond the City of Sydney LGA at a cost of \$535.5 million (\$129.9 million in 2012 dollars).

The mix of renewable energy technologies to deliver the City's renewable electricity target is based on today's assessment of technologies and estimated costs. However, the development of new and existing renewable energy technologies and associated costs in a downward trend may change this assessment as we move forward to 2030.

RENEWABLE ENERGY RESOURCES INSIDE THE CITY OF SYDNEY LGA

SOLAR AND WIND ON BUILDINGS

Solar electricity PV, solar hot water and micro or mini wind turbines could provide up to the equivalent of 15.2% of the City's electricity demand.

Solar electric PV panels could provide an estimated 455 GWh a year of electricity using 7.3% of total roof space in the City of Sydney LGA which has been assessed to be suitable based on aspect, orientation and solar access. This is a 350 fold increase on the amount of solar PV currently used in the LGA.

Solar hot water systems would displace the need for 138 GWh a year of grid electricity installed on 2.8% of the roof space. Micro and mini wind turbines on buildings over 30 storeys high could only provide a relatively minor contribution toward the target, due to a lack of buildings in the city higher than 100 metres.

Estimated delivered costs found that solar PV and micro wind are currently the cheapest renewable electricity technologies and these technologies, together with solar hot water, are cheaper than most utility scale renewable electricity technologies.

SOLAR, WIND AND GEOTHERMAL AT PRECINCT SCALE

Solar thermal power systems could provide 1.2% of the City's electricity needs in 2030. Direct use geothermal heating could also supplement future trigeneration thermal reticulation networks. Wind turbines require large areas of land with buffer zones but geothermal requires little land surface. These technologies have been successfully installed in urban locations overseas. Further wind energy assessments would be required as part of any development application. Further investigation of direct use geothermal would also be required as the potential of this renewable resource may be far greater than the resource modelled for this Master Plan.

Estimated delivered costs found that direct use geothermal hot water connected to trigeneration networks is the cheapest renewable energy technology and this technology, together with concentrated solar thermal, are cheaper than most utility scale renewable electricity technologies. Although not considered directly for this Master Plan evidence from overseas also suggest that precinct scale solar hot water connected to the trigeneration reticulation network is also one of the cheapest forms of renewable energy.

RENEWABLE ELECTRICITY RESOURCES BEYOND THE CITY OF SYDNEY LGA

At least 12% of the City's electricity demand will need to be met from renewable electricity generation deployed from a range of renewable energy technologies beyond the City of Sydney LGA but within the 250km proximity zone to deliver the City's renewable electricity target.

Estimated delivered costs found that onshore wind, offshore wind and concentrating solar PV were the cheapest renewable electricity technologies. However, concentrating solar thermal, geothermal electric, wave, tidal and new hydro could become cost competitive by 2030. In addition, these technologies could also provide a significant renewable energy mining resource for export which could improve the economics still further. Utilising emerging 'power to gas' technologies could not only overcome the intermittency of renewable electricity generation utilising the existing gas storage infrastructure it could also enable Australia to access large amounts of solar, wind and marine energy resources for export, even in the remotest parts of Australia using liquefied renewable gas technologies. See Renewable Energy Mining and Exports in this section.

RENEWABLE ELECTRICITY AND FOSSIL FUEL SPINNING RESERVE

Intermittent renewable energy technologies such as solar and wind cannot generate electricity all of the time. Backup supply is required, typically from coal or gas power stations, so that electricity can be immediately supplied when periods of little or no sun or wind exist.

In practice, fossil fuel power stations take time to start up and there would be a power cut if the fossil fuel power station generator was not already running on part or no load. This is referred to as 'spinning reserve' and has greenhouse gas emissions associated with the need to provide fossil fuel back up to intermittent forms of renewable energy.

Non intermittent forms of renewable energy such as renewable gas fuelled trigeneration do not require fossil fuel spinning reserve so it is important to develop these technologies, along with renewable heat and 'power to gas' storage technologies as part of the mix to completely replace fossil fuel generation.

RENEWABLE GASES FROM WASTE

This Master Plan also identifies the potential of renewable gases that can be recovered from virtually all forms of waste that are not otherwise recycled, such as from residential and commercial garbage, sewage and landfill. Beyond the city, renewable gases can also be sourced from livestock manure, agricultural stubble and husks from crops or non-native forestry off-cut waste.

Energy crops and native woodlands have been excluded from this Master Plan to avoid any potential land use conflicts with food crops and destruction of native woodlands. However, some forms of energy crops may be supported in this Master Plan where it can be shown that there are other beneficial environmental uses such as oil Mallee crops playing a role in long-term sustainable farming in low rainfall areas to decrease the salinity levels of the land.

Another biomass feedstock opportunity could be the use of bushland fire hazard reduction materials, particularly where near to renewable gas collection or generation plants. Utilising these combustible materials for renewable gas production could significantly reduce the current fire hazard reduction burn-offs, with consequential air pollution and adverse health impacts, and the risk of accidental bushfires.

Thermal gasification of dry and semi-dry wastes such as residential, commercial, industrial, and biomass waste produces a synthesis gas or syngas, anaerobic digestion of wet wastes such as livestock manure and sewage produces a biogas and landfill produces a biogas directly. The gases from these wastes can be converted into a substitute natural gas (SNG) and brought to the city within the existing natural gas pipe network or by liquefaction and transport to the nearest natural gas pipe network.

A trigeneration decentralised energy network operating 24 hours a day at 372 megawatt electrical (MWe) capacity could use the renewable gases recovered from waste. Natural gas fuelled trigeneration provides low carbon electricity and zero carbon heating and cooling. This reduces greenhouse gases being emitted from connected buildings by up to 60%.

Using renewable gases instead of natural gas would effectively deliver a 100% renewable energy system and produce virtually zero net greenhouse gas emissions. Renewable gases are currently the least developed form of renewable energy in Australia so further work was undertaken to determine the actual potential renewable gas feedstock resource and the economics of renewable gas technologies which are included in this Master Plan.

Using renewable gases from waste in the City's planned trigeneration network will also overcome the problem of ensuring the reliable and consistent supply of local energy into the future without the need to rely on fossil fuel spinning reserve.

Further energy can be harnessed by converting inorganic waste into syngas. However, for the purposes of this Master Plan organic waste only has been taken into account for the supply of renewable gases to the City's planned trigeneration network. Gas derived from inorganic waste represents an additional, virtually zero carbon, unconventional non fossil fuel resource.

Renewable gas waste resources were assessed up to 250km from the City of Sydney LGA and it was established that there were sufficient waste resources within 100–150km of the City's LGA to produce enough renewable gas for 100% of the fuel needed to supply the City's planned trigeneration network. The renewable gas/substitute natural gas (SNG) resource can therefore be met from within the City of Sydney, the Sydney Metropolitan Area, and in neighbouring regions within NSW.

The renewable and non fossil gas resources available 'locally' is 48.96 petajoules a year (PJ/year) of syngas and biogas, of which 37.06PJ/year is renewable gas and 11.9PJ/year is non fossil fuel gas. The renewable gas component of waste is more than the 27PJ/year needed to replace 100% of the natural gas supplying 372MWe of trigeneration in the City of Sydney's four proposed low carbon zones or even the 32.7PJ/year needed to supply 477MWe of trigeneration and cogeneration across the City of Sydney's LGA as set out in the Decentralised Energy Master Plan – Trigenation. This renewable gas resource will even supply the 34.7PJ/year, including the 2PJ/year of domestic gas used for domestic heating and cooking, needed to replace 100% of the fossil fuel natural gas in the City's LGA.

It should be noted that the renewable gas modelled for the Renewable Energy Master Plan does not capture all of the biogas available from agriculture and farming within the 250km proximity zone as only a portion of biogas was needed to supplement the renewable syngas from municipal solid waste and commercial and industrial waste to supply the City of Sydney proposed trigeneration network and most of this renewable gas resource can be captured within 100km of the City of Sydney LGA. However, the proportions of syngas and biogas may well change

by 2030 depending on the uptake of the different renewable feedstocks and technologies.

The potentially large biogas resource represents a significant economic opportunity for the agriculture and farming community as well as the gas utilities, particularly if the German renewable gas model is followed for NSW. See Germany Biogas Grid Injection Program case study in Chapter 6. Not only would biogas injected into the gas grid recover up to four times the primary renewable energy resource than renewable electricity generation only it would also mitigate current waste disposal costs as well as producing a non intermittent form of renewable energy from a resource that does not have to be mined with minimal negative impacts on the environment.

The by-product of biogas as well as syngas generation from organic waste can be used as a high grade fertiliser as well contributing towards carbon farming initiatives. In addition, the by-product of syngas generation from inorganic or mixed waste is an inert mechanically strong material which can be used for road or building construction.

Converting waste into a renewable gas would also reduce pressure on Sydney landfill sites which are estimated to reach capacity by 2016. This will be addressed in the Advanced Waste Treatment Master Plan.

Trigenation supplied by any or all of the five renewable gases converted to substitute natural gas (SNG) and injected into the gas grid has the lowest marginal social cost of abatement than any renewable electricity technology, with the exception of micro wind energy on buildings which can only supply a fraction of the City of Sydney's LGA electricity needs, and could potentially have negative marginal social cost of abatement by 2020.

Some forms of renewable gas/substitute natural gas will potentially be cheaper than fossil fuel natural gas in the immediate future and significantly cheaper than natural gas by 2030. See 'Cost of Renewable Gas' in Chapter 4. In order to capture the benefits of this low cost form of renewable energy a new regulatory regime and Government led market development approach will need to be adopted similar to the German model to maximise the efficiency and emissions reduction of renewable gases and to prevent 'price gouging'. See 'Develop Regulatory Regime for Renewable Gases' and 'Implement a Government Led Market Development Approach to Renewable Gases' in Chapter 5.

The City's plans for precinct scale trigeneration would create a market for renewable gases which would otherwise not exist, thereby improving the commercial viability of energy from waste projects as well as contributing towards the rural economy.

'POWER TO GAS' TECHNOLOGIES

Increasing penetration of renewable electricity generation technologies such as solar and wind also increases the potential to over-generate where renewable generation exceeds demand. Currently, wind turbines would be switched off to prevent this from happening and renewable energy generation is lost.

Converting renewable electricity to renewable gas is a new way of storing surplus energy from renewable sources, such as solar and wind, until it is required, balancing long term fluctuations in generation and removing the link between generation and demand.

The conversion process involves using renewable electricity to electrolyse water, producing hydrogen gas for injecting into the gas grid. The 'Power to gas' Renewable Electricity to Renewable Gas project, Falkenhagen, Germany in Chapter 6 identifies that under existing gas regulations, up to 5% hydrogen can be added to the natural gas grid without any problems, and in the medium term experts expect up to 15% can be added to the gas grid. Above this amount hydrogen can be converted into a syngas/substitute natural gas injected into the gas grid.

Converting renewable electricity to renewable hydrogen injected into the gas grid has a typical efficiency of 70% and converting renewable electricity to syngas/substitute natural gas injected into the gas grid has a typical efficiency of 56% for renewable electricity that would otherwise be lost. This compares with the 33% efficiency of a typical coal fired power station before grid losses.

In terms of energy storage, total existing gas storage facility capacity in the Eastern Australian gas market, excluding liquefied natural gas terminals, exceeds 150PJ, which is the equivalent of storing 41,700GWh of renewable electricity as renewable gas in the gas grid infrastructure, more than the entire Eastern Australian contribution to the Australian Mandatory 20% Renewable Energy Target.

MARGINAL SOCIAL COST OF ABATEMENT

The marginal social cost of abatement is the marginal or incremental cost to society of the modelled scenario versus business as usual. The analysis compares the baseline scenario of providing electricity by the predominantly fossil fuel fired electricity grid, against the scenario presented in the Renewable Energy Master Plan for electricity to be supplied using renewable energy technologies.

By 2020, micro wind and precinct scale trigeneration supplied by renewable gases from waste could potentially have negative marginal social costs of abatement, i.e. cheaper than coal fired electricity. However, micro wind is an intermittent renewable energy technology and can only provide a fraction of the City of Sydney LGA electricity requirements (less than 1%) whereas trigeneration supplied by renewable gases is a non intermittent renewable energy technology which could supply up to 70% of the City of Sydney LGA electricity requirements.

Precinct scale geothermal district heating and large scale onshore wind energy as low cost of carbon abatement technologies join micro wind and precinct scale trigeneration supplied by renewable gases negative cost of abatement technologies by 2025. Solar PV will also be a negative cost of carbon abatement technology by 2025. However, solar PV and large scale onshore wind energy are both intermittent renewable energy technologies. Solar energy within the LGA can supply/displace 16.3% maximum of the City of Sydney LGA electricity requirements.

All renewable energy technologies costs in the Renewable Energy Master Plan reduce with large scale onshore wind energy joining micro wind, precinct scale trigeneration supplied by renewable gases and solar PV as negative cost of carbon abatement technologies by 2030. However, only precinct scale trigeneration supplied by renewable gases is a non intermittent renewable energy technology capable of supplying, together with solar PV and some large scale onshore wind energy, 100% of the City of Sydney LGA electricity, heating and cooling requirements without interruption by 2030.

A NEW DIRECTION

To deliver sustainable change in the most cost and environmentally beneficial effective way, the City is developing Green Infrastructure Master Plans for decentralised energy (trigeneration and renewable energy), decentralised water, energy efficiency and advanced waste collection and treatment technologies. The abundant and relatively low operational cost nature of renewable energy resources makes the ongoing cost to produce renewable electricity, heating and cooling low following the initial capital cost investment.

If electricity is not used to supply heating and cooling which instead is supplied by the waste heat from local electricity generation (ie, trigeneration or cogeneration) and/or renewable heat then it makes it much easier and more economical to deliver a 100% renewable energy system.

Renewable electricity generation would provide 30% of the City of Sydney LGA electricity requirements. Together with the proposed trigeneration network, 100% of the city's electricity requirements in addition to thermal energy heating and cooling would be provided locally. This would effectively replace coal-fired electricity currently used in the City of Sydney LGA. Replacing Natural gas with renewable gases from waste over time would effectively supply the City of Sydney with 100% renewable energy at net zero greenhouse gas emissions by 2030.

TRACKING 2030 TARGETS

Figure 1 shows the renewable electricity generation contribution to the 30% renewable electricity target by 2030, Figure 2 shows the renewable gas generation contribution to the 100% renewable gas target by 2030 and Figure 3 shows the reduction in greenhouse gas emissions from renewable energy proposed by this Renewable Energy Master Plan, as well as from other green infrastructure by 2030.

FIGURE 1: CITY OF SYDNEY LGA RENEWABLE ELECTRICITY CONTRIBUTION TO 30% TARGET FOR 2030 (SOURCE: CITY OF SYDNEY)

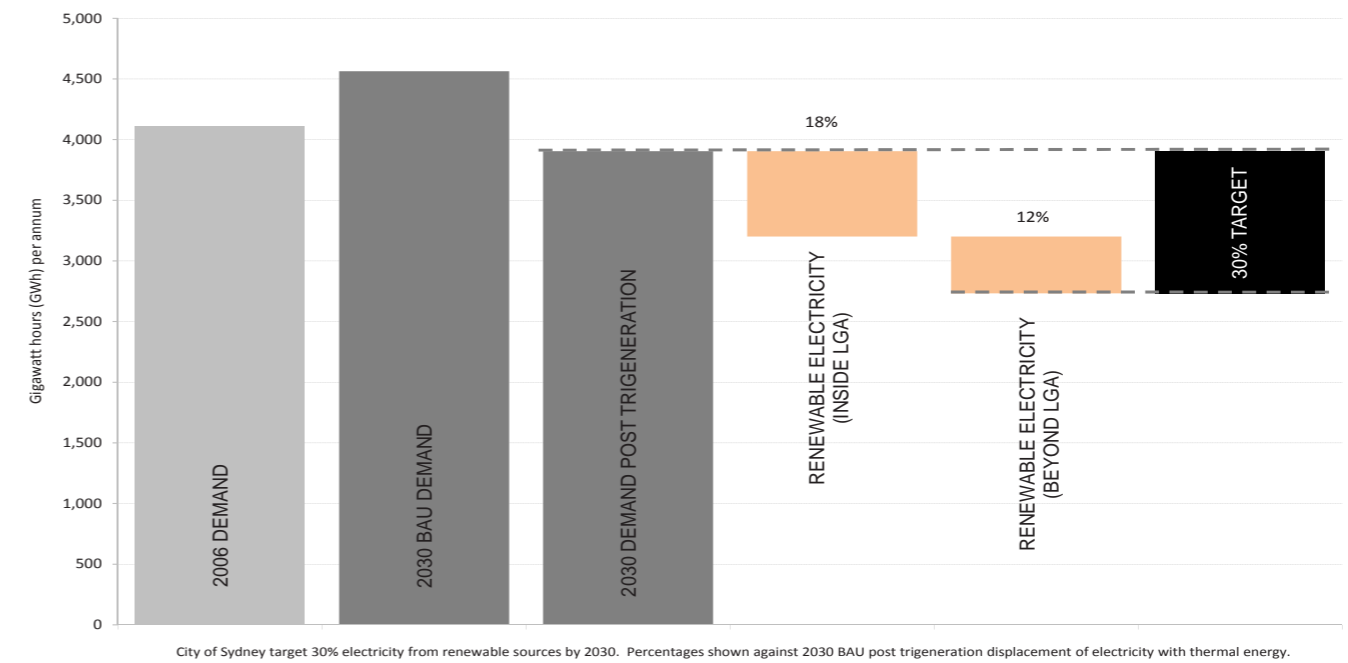

FIGURE 2: CITY OF SYDNEY LGA RENEWABLE GAS CONTRIBUTION TO 100% TARGET FOR 2030 (SOURCE: CITY OF SYDNEY)

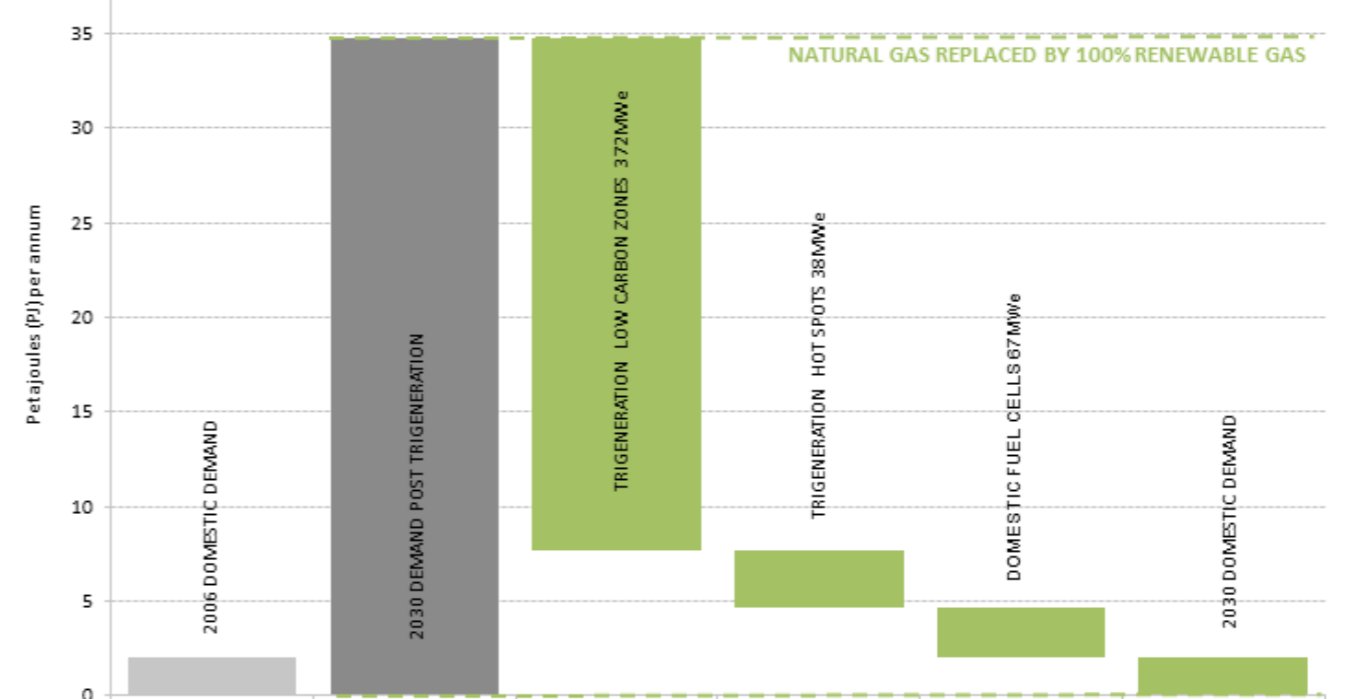

FIGURE 3: CITY OF SYDNEY LGA RENEWABLE ENERGY CONTRIBUTION TO 70% GREENHOUSE GAS EMISSION REDUCTION TARGETS FOR 2030 (SOURCE: CITY OF SYDNEY)

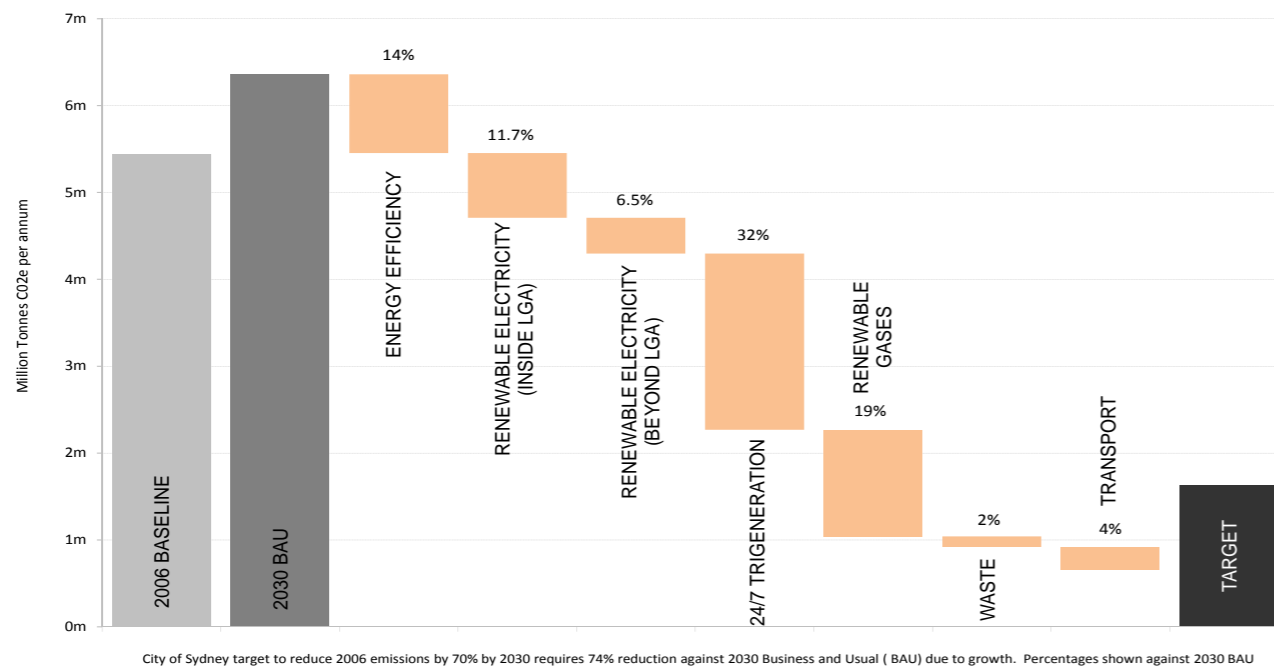
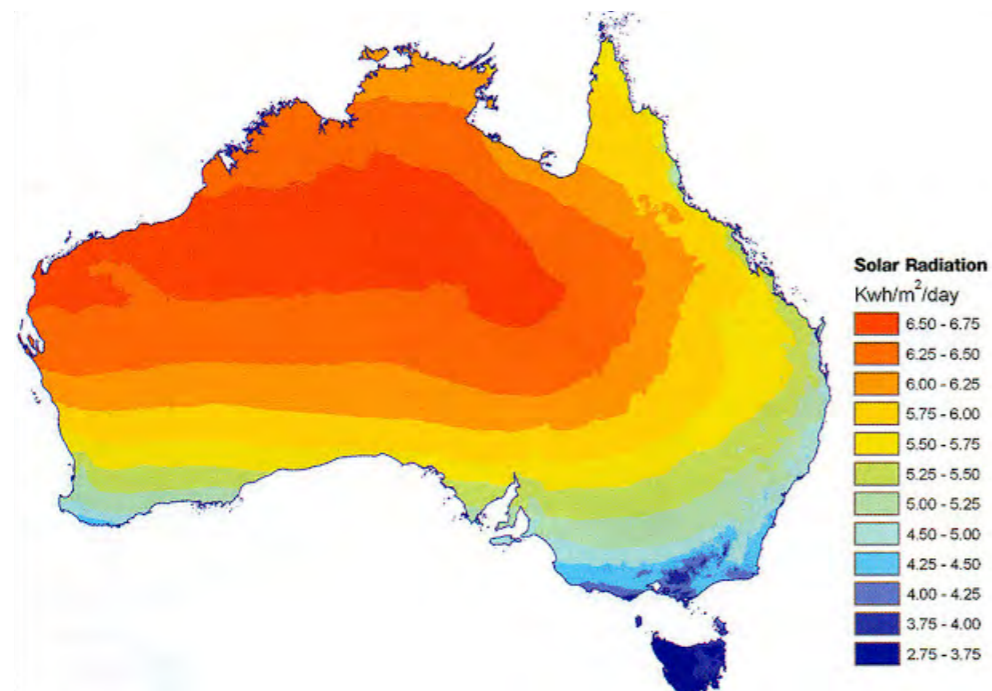

FIGURE 4: SOLAR INTENSITY MAP IN AUSTRALIA (SOURCE: ECO.LODGE.IT)



RENEWABLE ENERGY MINING AND EXPORTS

Australia's renewable energy resources are many times greater than Australia's annual energy needs. The annual solar radiation falling on Australia is approximately 58 million petajoules (PJ), about 10,000 times Australia's annual energy consumption. This compares with the 8,053PJ of black coal and the 1,086PJ of natural gas that Australia exported in 2010/11 at an economic value of \$31 billion.

Australia also has some of the best wind resources in the world. Good wind energy resources extend hundreds of kilometres inland from the coast and offshore, Australia has the 2nd largest wind energy resource in the world after the Russian Federation. Australia's marine or ocean renewable energy resources are also immense. For example, the wave energy resource from Geraldton to Tasmania alone would supply five times Australia's total energy requirements.

However, Australia's vast renewable energy resources will remain largely untapped due to Australia's current narrow view and mindset that renewable energy is only grid connected renewable electricity. For example, the outlook for wind energy in Australia is only

160PJ or 12.1% of the electricity generation output or 2.1% of Australia's total primary energy consumption in 2030. This is primarily driven by the view that wind energy is only for grid electricity and grids dominated by electricity generation from fossil fuels have difficulties in dealing with renewables other than hydro and tend to limit renewable electricity to 10-20% penetration due to power quality issues, installed capacity and current grid management techniques. Connection to the electricity grid transmission system is another limiting factor. To date, wind farm developments have mostly been in close proximity (less than 30km) to the grid.

Utilising emerging 'power to gas' and liquefied renewable gas (LRG) technologies is a game changer enabling Australia to access its vast renewable energy resources in the remotest parts of Australia for itself and for export, including solar, wind and marine energy resources that do not have to be located anywhere near an electricity or gas grid. The liquefied natural gas (LNG) infrastructure already exists in Australia and is currently being expanded for LNG exports so LRG can take advantage of this.

Australia is well endowed with mining expertise using complex engineering methods to extract fossil fuels for domestic consumption and for export so is well placed to use its mining expertise to take advantage of a new renewable energy mining market that is safer and cleaner than fossil fuel mining and able to provide continuous economic development and employment for the mining industry.

The potential for renewable energy mining and exports is beyond the scope of this Master Plan but if such a potential could be realised Australia could replace its fossil fuel exports with renewable energy exports contributing towards global emission reductions instead of increasing them at the same time as maintaining or increasing the economic potential of Australia's renewable energy resources which would never run out.

RENEWABLE ENERGY RESOURCES

1.

2.

3.

4.

5.

6.



RENEWABLE ENERGY RESOURCES

“By 2030 some renewable technologies, such as solar photovoltaic and onshore wind, are expected to have the lowest LCOE (levelised cost of electricity) of all of the evaluated technologies.”
— Australian Government Bureau of Resources and Energy Economics ‘Australian Energy Technology Assessment 2012.’

WHY THINGS HAVE TO CHANGE

GREENHOUSE GAS EMISSIONS

Renewable energy can play a large role in reducing carbon pollution in cities and increasing our energy independence in addition to health benefits from reduced air pollutants within urban communities.

Greenhouse gases trap heat in the atmosphere which is causing our planet to warm and contribute to climate change. Communities will always need energy, and sustainable solutions can be found.

Fossil fuel, in the form of coal, oil and natural gas, is currently the predominant source of harnessed energy. This is a non-renewable resource because it takes millions of years to develop from long dead deeply buried organisms fossilised over time. Therefore, fossil fuels cannot be renewed quickly.

Since industrialisation the majority of the world’s known deposits of fossil fuels have been consumed. It is estimated that production of conventional sources of oil reserves has more than 100 years left in the world, but may have reached its

peak. Both coal and oil are high-carbon fuels and are the primary contributors to global warming and climate change.

Australia has large natural gas reserves that are capable of sustaining the nation’s future production and exports well into and probably throughout the 21st century. However as fossil fuel deposits become harder to reach into the future, extracting deposits will become more costly. Access to fossil fuels from politically unstable regions worldwide also presents an issue for our energy security. This contributes to our pressing need to find alternative sources of energy that are renewable.

Burning fossil fuels releases carbon dioxide and other greenhouse gas emissions into the atmosphere. Carbon dioxide is the main greenhouse gas contributing to climate change.

Consumption of electricity and gas within city buildings is the largest contributor to greenhouse gas emissions with 80% of the City of Sydney LGA greenhouse gas emissions coming from centralised mostly coal-fired power generation. The demand for energy varies with each land use and building footprint. Figure 5 illustrates the projected carbon emissions across the city in 2030 from electricity and gas consumption on a

business as usual basis taking account of growth and the 20% Renewable Energy Target. The amount of emissions is represented by the vertical height and the intensity by the darkness of the colour.

FIGURE 5: 2030 PROJECTED BUSINESS AS USUAL BUILDING GREENHOUSE GAS EMISSIONS (SOURCE: TRIGENERATION MASTER PLAN)

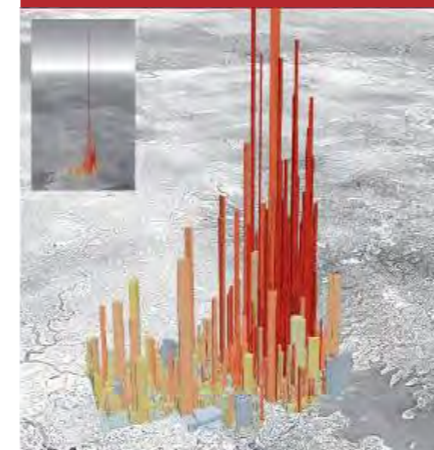

RISING ELECTRICITY COSTS

In NSW, electricity networks are undertaking capital expenditure of \$17.4 billion over the 5 years to 2013/14. Average local electricity prices are expected to rise during this period with

the proportion of power bills that goes to pay network charges estimated to rise by up to 60% of the typical energy bill.

Recent increases in retail electricity prices for households and businesses in NSW are mainly due to upgrades in the network infrastructure required to meet growing peak demand in electricity, primarily for electric air conditioning. Renewable energy that is generated within or in close proximity to the city would avoid or delay the need for transmission network infrastructure upgrades.

RENEWABLE ENERGY AS A SOLUTION

Renewable resources are those that can naturally replenish themselves. The main sources of renewable energy are sunlight, wind, water, tides, rain, geothermal heat, and organic waste.

Renewable energy technologies are predicted to become cost competitive in comparison to fossil fuels. Advancements in materials, manufacturing and installation techniques, mass manufacturing, increased demand, potential removal of the regulatory barriers to decentralised energy and the potential for further innovation are expected to drive the costs down.

1 RENEWABLE ENERGY RESOURCES

2 RE-THINKING RENEWABLE ENERGY

3 RENEWABLE ENERGY FOR THE CITY OF SYDNEY

4 PERFORMANCE MEASURES

5 ENABLING THE MASTER PLAN

6 CASE STUDIES

1.

TECHNOLOGY SOLUTIONS FOR SYDNEY

The renewable energy technologies commercially available today (or will become commercially viable by 2030) that will deliver the City's targets are applied at various scales from building applications, to precinct-wide within the city, and to regional areas surrounding metropolitan Sydney.

The Renewable Energy Master Plan presents an evaluation of renewable energy resources, including renewable electricity and renewable gas from waste. This Master Plan has categorised the key technologies into:

1. BUILDING SCALE RENEWABLE ELECTRICITY & HEAT WITHIN THE CITY OF SYDNEY LGA

These installations are typically less than 100 kilowatts (kW) in capacity and may include technologies that generate electrical energy and/or thermal energy.

2. PRECINCT SCALE RENEWABLE ELECTRICITY WITHIN THE CITY OF SYDNEY LGA

These are larger scale, stand alone technologies producing greater than 100kW renewable energy and export electricity or thermal energy into local distribution networks.

3. UTILITY SCALE RENEWABLE ELECTRICITY BEYOND THE CITY OF SYDNEY LGA

Large installations outside of urban locations can take advantage of improved natural conditions, lower land values and can avoid land use conflicts. These can export electricity to the transmission or distribution network to be consumed within the city.

4. RENEWABLE GASES FROM WASTE AND BIOMASS WITHIN AND BEYOND THE CITY OF SYDNEY LGA

The varied waste streams, both organic and non organic, can be converted into gases and used in the planned trigeneration network. Energy crops and native woodlands have been excluded from this Master Plan to avoid any potential land use conflicts with food crops and destruction of native woodlands. However, some forms of energy crops may be supported in this Master Plan where it can be shown that there are other beneficial environmental uses such as oil Mallee crops playing a role in long-term sustainable farming in low rainfall areas to decrease the salinity levels of the land.

FIGURE 6: RENEWABLE ENERGY TECHNOLOGIES

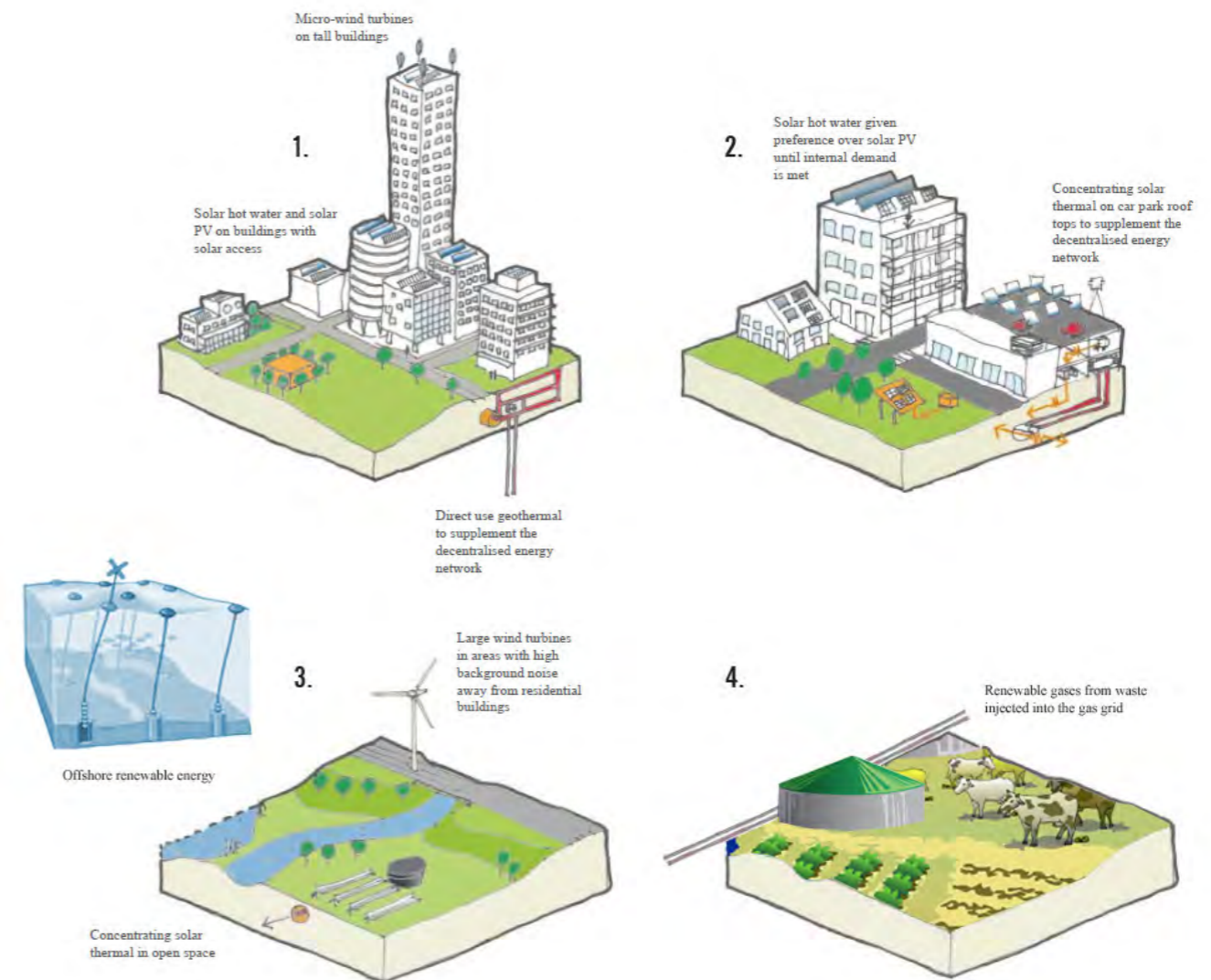

2.

3.

4.

5.

6.

Thirty (30) renewable energy technologies were screened for this Master Plan. The short list of fourteen (14) technologies listed is based on technologies that are commercially available today or will become commercially available by 2030.

EVALUATING THE OPTIONS

The key technologies considered in this Master Plan have been analysed across different contexts and scales. There are many opportunities to reduce greenhouse gas emissions based on currently available and proven technologies that can be realised by 2030.

A parameter of this Master Plan is to maximise local generation of renewable energy within the City of Sydney to offset increasing electricity retail and network charges and to maximise the recovery of renewable gas from renewable feedstocks within and beyond the City of Sydney. Meeting the renewable electricity quota from resources beyond the City of Sydney LGA is a second priority.

Renewable energy technologies and opportunities were assessed and prioritised using a stepped process based on:

1. Greenhouse gas emissions savings.
2. Marginal cost of energy.
3. Spatial land use constraints and site requirements.
4. Total generation capacity within and beyond the City of Sydney LGA.

Estimated delivered costs found that decentralised energy solutions such as building integrated and precinct scale renewable electricity technologies are cheaper than most utility scale renewable electricity technologies. This is primarily due to the rising costs of transmission and distribution network charges which can be reduced or avoided where renewable electricity is generated within the city. However, at least 12% of renewable electricity generation will need to be sourced from beyond the City of Sydney LGA.

TECHNOLOGY SHORTLIST



SOLAR PHOTOVOLTAIC (PV) PANELS

Solar photovoltaic (PV) technology converts sunlight directly into electricity. Sunlight is captured using semi conducting material in an electric circuit.

This technology has a high correlation with peak time demand in the city as solar PV without storage functions only during daylight hours. Solar panels should ideally be laid on a north facing roof pitched at 30 degrees. Installations facing west have a significant potential to generate power at peak times which is advantageous however they may reduce

total production. Commercial buildings can use PV sunshades affixed on the sides of buildings.

Newer and more efficient methods of manufacturing combined with better economies of scale are seeing the costs of PV installations significantly reduced, potentially making this technology one of the cheapest. Solar PV can reduce or delay the need for distribution network upgrades resulting in broader societal savings.

FIGURE 7: SOLAR PV, SURRY HILLS LIBRARY



CONCENTRATED SOLAR PHOTOVOLTAIC

Concentrated solar PV is at the precinct utility scale. It uses mirrors to concentrate the sun's energy onto PV panels to increase output at the scale of a power plant. It requires large sites that

are relatively flat, north facing, and with little shading. The PV cells can be fixed or track the sun throughout the day.



SOLAR HOT WATER

Heat is a form of energy. Solar hot water uses a flat plate or an evacuated tube collector technology to harness solar energy into heat. The solar collectors are linked to an insulated storage unit, such as a hot water tank. Typically a gas or electric booster is needed to supplement the solar heating.

Gas hot water systems are less carbon intensive than conventional electric systems. Replacing conventional electric hot water systems and lower greenhouse gas emissions is a priority. However, replacing gas boilers with solar thermal may not be as cost effective.

1 RENEWABLE ENERGY RESOURCES

2 RE-THINKING RENEWABLE ENERGY

3 RENEWABLE ENERGY FOR THE CITY OF SYDNEY

4 PERFORMANCE MEASURES

5 ENABLING THE MASTER PLAN

6 CASE STUDIES

- 1.
- 2.
- 3.
- 4.
- 5.
- 6.



SOLAR HOT WATER DISTRICT HEATING

Similar to solar hot water but at a much larger scale solar hot water district heating comprises a large solar hot water collection array, heat pump and thermal storage designed to inject hot water into the district heating or thermal reticulation network supplying heating and cooling via heat fired absorption chillers. The solar hot water contributes towards the other forms of fossil fuel or renewable generated heat and/or electricity supplying the district heating or thermal reticulation network so there is no need for gas or electric booster to supplement the solar heating.

FIGURE 8: MARSTAL DISTRICT HEATING



CONCENTRATED SOLAR THERMAL

Concentrated solar thermal power plants are at the precinct utility scale. Collectors use mirrors to concentrate radiation from the sun, heat fluids and drive an electric turbine. There are several major types of concentrating solar thermal including linear Fresnel reflectors, parabolic dishes and solar towers. Temperatures range from 150°C to over 1000°C. Most technologies either use steam turbines, sterling engines, organic rankine turbines or a combination of the above to generate both electricity and heat.

The minimum power plant size is 500 kWe and requires 0.5 ha area for linear Fresnel and trough technologies, and 1.8 ha for parabolic and large solar towers



MICRO OR BUILDING INTEGRATED WIND TURBINES

Wind power technology relies on the speed and frequency of winds to produce electricity. The conditions affect the period of time over which the turbines blades can rotate. The revolving blades on the rotor are used to power a generator.

Wind turbines can be pole-mounted and therefore can be placed in locations where solar PV is not suitable. Vertical axis wind turbines are usually selected for buildings where turbulence is prevalent.

Building integrated wind turbines can be larger and provide a significant portion of a building's electricity consumption.

Winds are stronger with heights above ground level. For Sydney, building heights need to be over 100 m or 30 storeys for building turbines to perform most efficiently.

FIGURE 9: RAZOR BUILDING LONDON



ONSHORE WIND

Onshore wind turbines are typically located on elevated ridgelines where wind speeds are the greatest or on open terrain.

In optimum conditions, large wind turbines are the most cost-effective type of renewable electricity technology. Onshore wind turbines can be constrained within urban settings but have been installed in major world cities. Typically a buffer distance from residential areas is required for large onshore wind installations.

Indicative analysis for Sydney indicates a 16–18% capacity factor.

1 RENEWABLE ENERGY RESOURCES

2 RE-THINKING RENEWABLE ENERGY

3 RENEWABLE ENERGY FOR THE CITY OF SYDNEY

4 PERFORMANCE MEASURES

5 ENABLING THE MASTER PLAN

6 CASE STUDIES



OFFSHORE WIND

Offshore wind turbines normally involve anchoring the turbines in the ocean and are typically much larger and more efficient than onshore wind turbines as better winds are available off shore and are more continuous compared to on land. Deepwater floating designs have also been recently developed in Europe.

FIGURE 10: OFFSHORE WIND FARM



Although currently more costly than onshore wind turbines, but cheaper than most utility scale renewable energy technologies by 2030, offshore wind turbines have the advantage of avoiding the noise and visual impacts of onshore wind turbines in rural environments.

Australia has one of the largest offshore wind energy resources in the world, second only to the Russian Federation¹. Wind speeds off Sydney are between 7m/s and 10m/s.

Indicative analysis for 20km off Sydney indicates a 40% capacity factor.



GEOTHERMAL ENERGY

Geothermal energy uses the heat stored in the Earth's subsurface to provide heating and cooling, as well as for electricity where temperatures are high enough. Water is pumped through geothermal aquifers several kilometres underground and returned to the surface as hot water.

There is significant potential for 'direct use geothermal' technologies to supply thermal energy for heating and cooling of spaces and district heating. Two types of direct use geothermal technologies are currently available:

- Circulating Hot Water for large scale installations to complement trigeneration decentralised thermal energy networks.
- Ground Source Heat Pumps for individual buildings not connected to a trigeneration thermal energy network providing space heating and cooling.

Circulating Hot Water wells are typically drilled to a depth of several hundred meters and less than 1 km, where the subsurface temperatures are expected to be high enough to heat water to a temperature suitable for injection in a trigeneration decentralised thermal energy network. The hot fluids that are brought to the surface are most commonly used for commercial and industrial heating or cooling.

Ground source heat pumps, which recovers low temperature geothermal energy from shallow ground and then multiplies the thermal energy using a heat pump, could be used for smaller applications not connected to the trigeneration network, such as residential and small non-residential buildings. Geothermal energy is either recovered from large scale shallow trenches or from boreholes typically drilled to tens of metres. Geothermal heat pumps are normally connected to the fossil fuel electricity grid and for back-up so are partial renewable energy technologies only unless receiving electricity to run the pump from a renewable electricity generation system.

The other type of geothermal energy is for electricity generation drilling down into the earth up to 5 km to convert the deep heat stored in the earth into electricity. This uses steam to

drive conventional turbines. However, electricity generation would require temperatures around 150°C and above.

Temperatures beneath the ground surface in Sydney are unlikely to be high enough for electricity generation with current, commercially available, geothermal turbine technology but may be high enough for use on a trigeneration thermal reticulation network.



WAVE POWER

Australia has considerable wave energy resources in reasonable proximity to cities and potential industry users. For example, wave energy capacity from Geraldton to Tasmania alone is over 1,300TWh/yr, about five times Australia's total energy requirements².

Surface waves are created from friction between the heating of air above ocean waters by the sun and the winds blowing across the surface of the ocean. Peak wave power is generally achieved in deeper offshore waters.

Wave energy converters typically use floating buoys, platforms, barrage like structures or submerged devices to generate electricity. These can be placed anywhere from on the water's surface or submerged on the shoreline or up to 100 km offshore.

¹ Stanford University Offshore Wind Energy Potential: A Global Approach 2012 https://people.stanford.edu/cmakridi/sites/default/files/Makridis%20-%20Offshore%20Wind%20Energy%20Potential_site.pdf

² CSIRO Ocean Renewable Energy (ORE): 2015-2050 July 2012 <http://www.csiro.au/en/Organisation-Structure/Flagships/Energy-Transformed-Flagship/Ocean-renewable-energy.aspx>

1.

2.

3.

4.

5.

6.

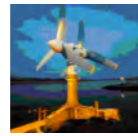

TIDAL ENERGY

Tidal energy is a consistent and relatively accessible resource with the potential to provide about 0.5% of Australia's electricity.

Tidal electricity is captured from the high tide to low tide water movements in rivers, oceans and estuaries. The technology is suited to areas with high ocean tidal ranges to ensure turbine efficiency. Tidal energy is able to be captured via two main methods, either in-stream or tidal barrage.

Tidal barrage and tidal pond systems generate electricity by forcing water through a sluice gate and turbine. The technology is similar to hydroelectricity, except that it relies on the tide to move water rather than a consistent flow of water. Tidal stream or marine current energy works in a similar way to wind power, where the flow of water forces blades to turn and generate electricity.

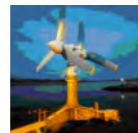

NON TIDAL ENERGY

The potential capacity for non tidal or ocean current energy is large at 44TWh/yr or 20% of Australia's total electricity requirements or nearly 60% of NSW electricity requirements (Ref: CSIRO ORE).

The Eastern Australian Current flows from Queensland into New South Wales and flows mostly as a fast narrow jet along the upper continental slope between Fraser Island and northern NSW and then onwards continuing its flow past eastern Tasmania.

Horizontal or vertical axis turbines can be used, the latter better for turbulent flows. Other designs such as oscillating hydrofoil devices have also been developed.

FIGURE 11: NON TIDAL OCEAN CURRENT ENERGY

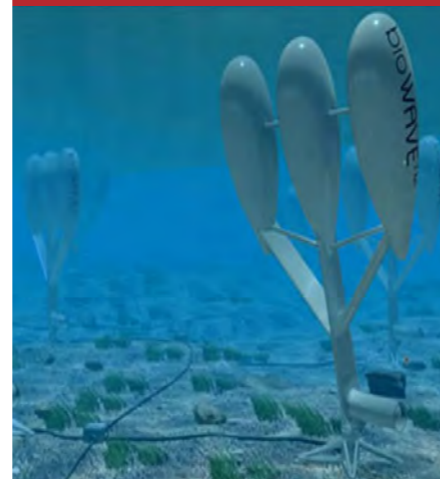

RENEWABLE GAS FROM WASTE AND BIOMASS

Various biological and thermal technologies create gas from waste or biomass which can be used in place of natural gas. The main technologies are:

- Pyrolysis or thermal gasification to produce syngas.
- Anaerobic digestion to produce biogas.
- Landfill gas capture.

These gases can be used directly or upgraded to substitute natural gas for use in existing mains gas infrastructure.

Treating waste to produce a useful gas is a very efficient process and avoids many environmental problems associated with traditional waste disposal such as greenhouse gas emissions from landfill.

Additional costs of advanced waste treatment technologies can be offset by revenues from selling the renewable gas, and avoided landfill levies and price on carbon.

For maximum benefit, renewable gas from waste should be used for cogeneration or trigeneration where both the heat and electricity generated can be used to increase overall efficiency compared to electricity generation only which loses the heat energy.

Technologies such as advanced gasification are now available that after recovering recyclable materials, can convert virtually all organic and non-organic waste into gases. Gas produced from organic waste input is renewable energy and gas produced from inorganic waste input is not renewable energy but a form of non-fossil fuel energy. Only renewable gas produced from organic waste has been included towards the City's renewable energy target.

Waste to energy technology is most efficient where treatment is located close to the source. Renewable gas resources produced at distant locations require upgrade and transport to the City by injection into existing pipelines or liquefaction and delivery by truck to the nearest natural gas pipe network.

RENEWABLE ENERGY MINING AND EXPORTS

Australia's renewable energy resources are many times greater than Australia's annual energy consumption. For example, Australia's solar resource is 10,000 times Australia's annual energy consumption. Australia also has the 2nd largest offshore wind energy resource in the world after the Russian Federation and the wave energy resource from Geraldton to Tasmania alone would supply five times Australia's total energy requirements.

Utilising emerging 'power to gas' and liquefied renewable gas (LRG) technologies Australia could access large amounts of renewable energy resources in the remotest parts of Australia for export, including solar, wind and marine energy resources that do not have to be located anywhere near an electricity or gas grid.

The liquefied natural gas (LNG) infrastructure already exists in Australia and is currently being expanded for LNG exports so LRG can take advantage of this.

The potential for renewable energy mining in Australia is beyond the scope of this Master Plan but if such a potential could be realised Australia could be exporting renewable energy and contributing towards global emission reductions instead of exporting carbon and increasing global emissions.



RE-THINKING RENEWABLE ENERGY

1 RENEWABLE
ENERGY
RESOURCES

2 RE-THINKING
RENEWABLE
ENERGY

3 RENEWABLE
ENERGY FOR THE
CITY OF SYDNEY

4 PERFORMANCE
MEASURES

5 ENABLING THE
MASTER PLAN

6 CASE STUDIES

RE-THINKING RENEWABLE ENERGY

1.
2. **Renewable energy can play a large role in reducing carbon pollution in cities, increasing our energy independence, and health benefits from reduced air pollutants within urban communities.**

Electricity used in the City of Sydney is currently provided by a remote, centralised, predominately coal-fired electricity grid. This is highly polluting and electricity used in the City of Sydney LGA accounts for 80% of total greenhouse gas emissions.

3. More than two thirds of primary energy is lost in the form of waste heat evaporated into the atmosphere at remote power stations and losses in the electricity grid network. Decentralising and reducing the carbon content of our energy supply can reduce waste, greenhouse gas emissions and cost.

4. This Master Plan focuses on the stationary energy sector. Transport fuels are not specifically addressed however an amount of electric vehicle uptake has been assumed in 2030 business as usual modelling scenarios. In addition this Master Plan identifies a substantial renewable gas from waste resource which could also be used by the transport sector.

TRANSFORMING OUR ENERGY

The City has an opportunity to transform the provision of energy using renewable energy sources. This transformation requires a combination of technologies to meet the City's targets. There is no single technology solution.

Buildings, whether residential, industrial or commercial, can use onsite renewable energy technology to generate electricity and heating for the building. A small, local renewable power plant within the city could generate power for consumption within the local distribution network.

Electricity produced at a great distance from cities requires major transmission and distribution infrastructure and its associated costs. These inefficiencies increase consumers' electricity bills and the amount of greenhouse gas emissions. Therefore, there is greater value in generating renewable energy close to where it will be consumed.

5. Generating renewable electricity and replacing natural gas with renewable gases to supply a decentralised trigeneration energy network would be a significant step for decarbonising Sydney.

Australia wide, energy supply scenarios are rapidly changing due to changing demands, renewable energy targets and a price on carbon among other factors. In the last 5 years there has been a significant trend in renewable energy generation concurrent with a decreased output from fossil fuel generation.

6. As a preliminary step towards a renewable energy future the Australian Energy Market Operator (AEMO) submitted a report to the Australian Government in July 2013 indicating that a 100% renewable electricity system was possible but would require much higher capacity reserves than a conventional power system. The AEMO report covered two 100% renewable electricity generation mix scenarios at 2030 and 2050. However, although the AEMO report took bioenergy into account it did so as renewable electricity generation only. AEMO did not study or take into account renewable gas grid injection which can be up to four times more energy efficient at end use than renewable electricity generation only from renewable gas or 'power to gas' technologies that can economically overcome the intermittency of solar and wind through energy storage in the existing gas grid.

SECURING OUR ENERGY

A decentralised renewable energy network in the city would encourage low carbon energy generation and provide secure, safe energy in a cost-effective way. It would also reduce the dependence on high carbon-centralised fossil fuel generation imported via the electricity grid.

The benefits of decentralised renewable energy include:

- Delaying or avoiding grid electricity network infrastructure upgrades which would reduce network charges passed on to consumers.
- Reduced burning of fossil fuels.
- Avoiding the loss of energy from remote centralised energy generation by decentralising energy generation closer to the source of consumption.
- Reduced air emissions and pollutants.
- Community awareness, behaviour change and demand management.

Conventional renewable energy technologies such as solar and wind are not always available to generate energy 24 hours a day, each day of each year, when the physical conditions are less than optimal, such as on a cloudy or windless day. This creates a challenge in providing consistent and reliable supply of renewable energy.

The performance of any one renewable energy technology may vary considerably from location to location depending on the daily and seasonal climate, topography and other geophysical conditions.

However, on a broad scale this problem of renewable energy being intermittent can be overcome, by combining a diverse amount of renewable energy technologies together, some of which are non-intermittent, and which are embedded within the network.

If these technologies are distributed across different regions of Sydney and NSW, then, where physical conditions are not favourable in one location, they can be compensated by favourable conditions in another location. Non-intermittent renewable energy technologies, such as direct-use geothermal and renewable gases, will also assist with this. Energy storage can also be incorporated.

Many of the technologies can be rolled out in the short to medium term. Implementing renewable energy would not cause major disruptions to activity.

The Australian Government renewable energy target is 20% of Australia's electricity to be supplied by renewable sources by the year 2020. The Australian Government set a target to reduce 2000 greenhouse gas emissions by 5% by 2020.

NSW is part of the National Electricity Market and has the potential to contribute a proportion to the national grid. The 20% Australian renewable energy target will result in a 'greening of the grid' with increasingly lower carbon intensity. This has been taken into account when calculating the emissions savings in this Master Plan.

The City of Sydney's renewable electricity target relates to electricity generated locally and within nominal 250 km proximity of the city. It is not the intention of this Master Plan to meet the City's 30% renewable electricity target by sourcing renewable electricity in the form of Green Power from the national grid.

This Renewable Energy Master Plan will make a noticeable contribution to Australia's carbon reduction target.

BACK-UP POWER & INTERMITTENCY

Coal-fired electricity generation is the major source of electricity in Australia. Generators continuously burn coal to supply electricity to the grid, with limited capacity to fluctuate between peak and non-peak demand, for instance, overnight when energy demand is low.

As power stations take time to power up some of the power stations have to be run on part load or no load so that they can immediately supply electricity to the grid to avoid a power cut in the event that the sun is not shining or the wind is not blowing. This is what is known as 'spinning reserve'. It produces additional greenhouse gas emissions and is a very inefficient means of energy production.

If renewable energy is eventually to replace fossil fuels 100%, renewable energy systems will need to become non-intermittent; otherwise they will still require fossil fuel spinning reserve. This Master Plan identifies that there are sufficient opportunities for large scale, non-intermittent renewable energy to supply the City of Sydney.

1 RENEWABLE ENERGY RESOURCES

2 RE-THINKING RENEWABLE ENERGY

3 RENEWABLE ENERGY FOR THE CITY OF SYDNEY

4 PERFORMANCE MEASURES

5 ENABLING THE MASTER PLAN

6 CASE STUDIES

1.

2.

3.

4.

5.

6.

There are currently few cost-effective ways to store electricity when it is not being used. To avoid wasting energy and greenhouse gas emissions, electricity generation should match fluctuating demands throughout the day and the seasons. Reducing electricity consumption through energy efficiency and using renewable thermal energy for heating and cooling to displace electricity consumption and peak power will also make it much easier to reduce intermittency and to deliver the renewable electricity target.

Decentralised renewable energy can respond rapidly to local electricity demand and reduce or eliminate the need for fossil fuel spinning reserve. This highlights the need for investment into reliable, non-intermittent renewable energy.

Renewable gas is the principal, non-intermittent, renewable energy technology identified in this Master Plan. It will overcome the need for fossil fuel spinning reserve electricity generation capacity. This technology also provides the pathway to a 100% renewable energy city.

Other solutions include improvements in technologies for battery storage, such as those in electric vehicles, or pumping water up a gradient to store energy, thermal storage to enable surplus renewable electricity generation and the utilisation of waste heat at different times of the day via trigeneration, thermal storage of steam or molten salts for solar thermal concentration, super charging natural gas or renewable gas via solar thermal concentration and increasing the gas energy content by 25% with solar gas, 'power to gas' technologies, and the storage and utilisation of energy via electrolyzers and hydrogen fuel cells.

WHAT IS THE COST OF RENEWABLE ENERGY?

For the five year period 2010–2015, electricity network businesses in Australia will be spending over \$46 billion on upgrading the electricity grid and providing for peak power brought about by electric air conditioning. This expenditure is the primary cause for the current sharp rise in electricity prices since 2010, not renewable energy.

In NSW, for the five year period to 2013/14, electricity network providers are undertaking capital expenditure of \$17.4 billion. This represents \$2,400 per person and an 80% increase on the previous five-year period. In the Sydney area average Ausgrid electricity prices are expected to rise by as much as 83% with network charges representing 50% to 60% of the average electricity bill. Renewable and decentralised or distributed energy has significant potential to avoid or delay investment in network infrastructure.

The demand for higher environmental standards is increasing and requirements in building codes into the future may also increase. As bulk demand increases for renewable energy technology, so too do the economies of scale, which will help reduce the costs of technology, materials, and installation costs.

Coal-fired electricity prices will rise further in the future partly due to the increasing cost of fossil fuel extraction and partly due to the very high cost of grid network investment and charges. However, renewable energy prices will reduce in the future, partly due to increased economies of scale and low operating costs and partly due to the decentralised energy nature of most forms of renewable energy which can avoid the very high grid network charges.

Financial analysis of each of the renewable electricity and gas technologies is based on the levelised cost of electricity (LCOE) or the levelised cost of gas (LCOG), respectively. The LCOE or LCOG of each technology, as applicable, is the minimum cost of energy at which a generator must sell the electricity or gas produced using that technology in order to achieve its target level of return.

The LCOE or LCOG of each type of generation capacity, as applicable, is dependent on the following factors:

- capital costs;
- fixed operating cost;
- variable operating costs;
- fuel costs;
- carbon price;
- capacity factor;
- the discount rate; and
- the amortisation period.

While the real cost of fossil fuels goes up, the upfront cost of renewable energy technologies is coming down with lower operating costs.

After the LCOE or LCOG is calculated, the 'delivered cost' of each renewable energy technology can be calculated. The delivered cost is equal to the LCOE or LCOG with transmission and distribution network costs added. This represents the actual cost incurred in delivering a unit of electricity or a unit of gas from a generator using each type of technology, to the final user.

As such, a renewable energy technology will only become financially viable if its delivered cost is less than or equal to the delivered cost of the baseline electricity or gas technology, which is assumed to be black coal without carbon capture and sequestration (CCS), the current primary source of base load power in NSW, for electricity and pipeline natural gas for gas.

Economic efficiency is attained when the efficient level of total emissions reduction is achieved at the lowest overall cost to society. The marginal social cost of abatement for each of the fourteen renewable electricity technologies, five renewable gas resources, and baseline technologies need to be evaluated in order to compare their relative cost-effectiveness in achieving greenhouse gas emissions abatement.

The methodology adopted for estimating the marginal social cost of abatement of the renewable energy technologies and resources is based on the same methodology that was used for the Decentralised Energy Master Plan – Trigeneration. However, when considering the hierarchy of renewable energy technologies and their associated marginal social cost of abatement account also needs to be taken of the amount of energy generated by each technology to achieve the renewable energy and carbon reduction targets, its ability to mitigate peak power and whether the energy generated is intermittent or non-intermittent, taking account of any associated energy storage technologies or capabilities.

Building scale technologies that generate and supply the buildings own energy needs avoid distribution and transmission network charges completely but would pay a distribution use of system charge for any electricity exported to other buildings across the distribution network or any electricity used from the transmission grid.

The economic dynamics of decentralised and renewable energy are constantly changing and increasingly more cost-effective as the costs of inefficient centralised power generation and associated grid infrastructure increase with the latter now forming the majority of the cost of grid electricity.

Due to the rapidly changing cost of renewable energy and high network charges, there is significant variance in assessments of renewable energy costs. One factor that is recognised however is that while the real cost of fossil fuels goes up, the upfront cost of renewable energy technologies is coming down with lower operating costs.

Financial and economic analysis of renewable energy opportunities is included in Chapter 4.

CARBON PRICING MECHANISM

From 1 July 2012, there is a price on carbon in the form of a tax at \$23 per tonne of carbon on Australia's largest polluters. A price on carbon can be considered as favourable to renewable energy due to the increase in the price of fossil fuel electricity, as fossil fuel generators will pass on the cost of carbon to the consuming market. This improves the relative business case for renewable energy investment.

The carbon price will rise in line with inflation until 1 July 2015 when the carbon price will be set by the market under an Emissions Trading Scheme. This is one factor that is making the cost of renewable technologies more competitive with fossil fuels.

A price on carbon excludes emissions from the combustion of biomass, biofuels and biogas and therefore will greatly facilitate the development of a viable market for renewable gas, including syngas and biogas.

Over time, the carbon pricing mechanism will change the pricing of energy so that renewable energy and non-fossil fuels will become more price competitive compared to fossil fuels.

1 RENEWABLE ENERGY RESOURCES

2 RE-THINKING RENEWABLE ENERGY

3 RENEWABLE ENERGY FOR THE CITY OF SYDNEY

4 PERFORMANCE MEASURES

5 ENABLING THE MASTER PLAN

6 CASE STUDIES

1.

2.

3.

4.

5.

6.

Should the carbon pricing mechanism be repealed by Parliament the City's renewable energy target will only be met by 2030 with higher subsidies, unless an alternative climate change mitigation policy framework provides similar benefits and incentives. This or the low scenario is covered in Technical Appendix 1. With the election of the Coalition Government it is uncertain what impact the repeal of the carbon pricing mechanism will have on electricity prices and renewable electricity prices in particular. However, it should be noted that advanced economies such as Germany, UK, Denmark, California and others have achieved far higher levels of renewable energy penetration than Australia on the back of energy policy not carbon pricing or emissions trading.

COST OF CARBON ABATEMENT

The marginal social cost of carbon abatement represents the additional cost per tonne of carbon abated by installing and producing renewable energy compared to business as usual energy over the lifetime of the technology. Energy from coal fired power stations receive many hidden government subsidies such as discounted coal, coal terminal lease fees, providing infrastructure so that coal can be transported to electricity generators or to port loading facilities, rail upgrades, avoidance of the NSW waste levy for the landfill of coal ash, tax credit on diesel fuel for coal trucks and machinery and carbon pricing compensation, quite apart from the health and environmental costs.

The costs are calculated using a base unit of carbon reduction over the life of the technology. Those technologies that deliver the greatest outcomes at the lowest cost of carbon abatement can then be prioritised.

The cost of carbon abatement improves the business case for those technologies that generate both electrical and thermal energy, particularly where the thermal energy is able to offset emissions from intensive electricity use (such as electric air conditioning, hot water systems and induction heating).

The greatest abatement over the period to 2030 will occur for technologies, particularly non intermittent technologies, which can be installed in the near to medium future. These technologies will offset grid electricity at current emission intensities currently dominated by fossil fuel technologies which are likely to be phased out by market forces.

Renewable energy can also receive subsidies, will not be subject to a carbon tax and will benefit from an emissions trading scheme. Building scale technologies will attract the greatest subsidies such that the cost of abatement to the city and its residents is further reduced. These subsidies effectively alleviate a portion of the cost burden, reducing the cost of abatement. Some technologies such as trigeneration fuelled by renewable gas, solar photovoltaics on buildings and large scale onshore wind energy may not require subsidies in the near future since they are near cost competitive with the fossil fuel grid.

Estimating the cost of abatement into the future is based on many assumptions. For example, some building scale technologies may include full retail prices factors compared to wholesale rates for utility scaled installations that could export to the grid. Also, the cost of renewable energy technology is likely to decrease, whereas fossil fuel generated electricity is likely to increase.

Other assumptions on price are detailed in Chapter 4, and cover capital costs, operational costs, technology efficiency and resource capacity, the level of intermittency/non intermittency, and the total carbon abated over the life of the technology.

FINANCIAL INCENTIVES

RENEWABLE ENERGY CERTIFICATES

Fossil fuel generation has relatively cheap capital and fuel costs. It receives government subsidies, and has a regulatory framework that supports large scale fossil fuel power stations on a centralised grid. This regulatory framework creates regulatory barriers to smaller scale decentralised renewable energy technologies which makes it difficult for renewable energy technology to compete on cost alone.

The Commonwealth Government has a Renewable Energy Target (RET) of 20% of electricity to be supplied by renewable energy by 2020 to improve the financial viability of renewable energy.

Revenue can be generated from producing renewable energy through large-scale generation and small-scale technology certificates. However, the certificates are forecast to decrease beyond 2020. 1 REC is equal to 1 MWh of electricity generated from renewable sources.

1 RENEWABLE ENERGY RESOURCES

2 RE-THINKING RENEWABLE ENERGY

3 RENEWABLE ENERGY FOR THE CITY OF SYDNEY

4 PERFORMANCE MEASURES

5 ENABLING THE MASTER PLAN

6 CASE STUDIES

FIGURE 12: LARGE-SCALE GENERATION CERTIFICATE PRICE PROJECTIONS
(SOURCE: THE ALLEN CONSULTING GROUP, BASED ON SKM MMA 2011)



FEED-IN TARIFFS

A well designed feed-in tariff has the ability to rapidly expand the uptake of renewable energy technologies at a marginal cost to society, as seen by the massive uptake of solar and renewable gases in Germany which has resulted in lower overall bills in part due to the merit order effect whereby network peak events (when energy prices are highest), are minimised.

The NSW Government implemented a feed-in tariff, known as the Solar Bonus Scheme NSW, in January 2010 to provide payment to energy customers with installed solar PV systems. However the scheme was initially too generous and poorly implemented which resulted in a boom and bust market for household PV installations.

Where buildings with solar PV are not adequately compensated, the rate at which the solar energy is sold may be well below the retail price of electricity, particularly during the peak and shoulder periods, and therefore subsidising coal fired power stations and grid transmission and distribution networks.

Poorly designed feed-in tariffs are not a cost effective or sustainable way of implementing renewable energy which increases electricity bills for all electricity consumers and be prone to sudden changes in policy. The tariffs also fail to target the non-intermittent or mix of renewable energy technologies that are needed for renewable energy to replace fossil fuels.

Optimal delivery and up-scaling of renewable energy can be achieved by:

- Removing the regulatory barriers to decentralised energy.
- Establishing mandatory renewable energy targets for new development.
- Carbon pricing.
- Providing targeted grants and/or feed-in tariffs for non intermittent renewable electricity and gas technologies.
- Mixing renewables to minimise or eliminate coal-fired spinning reserve and peak power.

REMOVAL OF THE REGULATORY BARRIERS TO RENEWABLE ENERGY

Decentralised renewable energy technologies such as building integrated solar PV and distribution connected onshore wind energy and precinct scale trigeneration supplied by renewable gases could be cost competitive now if the regulatory barriers to decentralised energy were removed negating the need for feed-in tariffs for these early technologies.

Such an approach would also incentivise and provide discipline in the connection and supply of renewable energy and matching generation with demand in association with energy efficiency and fuel switching mitigating the need to upgrade and augment the grid transmission and/or distribution networks which are costs borne by all electricity consumers.

This would enable government to concentrate financial support mechanisms for emerging renewable energy and associated technologies to overcome the intermittency of existing near commercial renewable energy technologies.

1.

LOCAL PLANNING AND DEVELOPMENT CONTROLS AND THE BUILDING CODE OF AUSTRALIA

Local planning and development controls could be implemented similar to the UK and other European Union countries requiring major new developments to generate a portion of the energy consumed by the development from on site or precinct scale renewable energy.

Similar local planning and development controls in London³ have provided a cost effective way of implementing zero or low emission generation in new development.

Similarly, the Building Code of Australia could be amended in accordance with the zero or low emissions generation (ZLEG) recommendations in the Department of Climate Change and Energy Efficiency Inclusion of Energy Generation in Building Energy Efficiency Standards report⁴.

The report sets out the technical potential of ZLEG for new and existing buildings if the Building Code of Australia was used to foster ZLEG. This breaks down into two major technologies and customer loads – solar PV primarily for the residential sector and precinct trigeneration for the commercial sector. For solar PV the technical potential is 8,126 GWh/year and for precinct scale trigeneration the technical potential is 9,300 GWh/year. This compares with the 8,465 GWh/year growth in forecast electricity consumption for the residential sector and the 6,300 GWh/year growth in forecast electricity consumption for the commercial sector, both by 2020.

Such an approach would mitigate the connection costs and energy growth of major new developments as well increasing renewable energy supply.

ENVIRONMENTAL UPGRADE AGREEMENTS

Environmental Upgrade Agreements (EUA) enables the low cost financing for retrofitting energy efficiency measures in non residential and strata multi-residential buildings. This can include local renewable energy such as building or precinct scale technologies under the Local Government Amendment (EUA) Act 2010. This funding program will make it easier for building owners and occupiers to implement building scale renewables in the city at an acceptable rate of return.

EUA's should be extended to new development in addition to existing development. Implementing renewable energy in new development as part of the construction works is more cost effective than implementing renewable energy under EUA's after the new development has been built.

CLEAN ENERGY ACT 2011

The Australian Renewable Energy Agency (ARENA) was created by the Act to consolidate the existing government programmes for renewable energy into a single body. ARENA's \$3.2 billion in funding is legislated and extends out until 2022 providing long term funding and policy certainty for industry. Around \$2 billion of ARENA's funding is currently uncommitted and available for ARENA to invest in accordance with its functions and powers. However, with the election of the Coalition Government \$150 million from ARENA's funding will be directed to the million solar roofs program.

The Clean Energy Finance Corporation (CEFC) is the other main renewables initiative in the climate change package. It will use publicly provided money to drive renewable energy and energy efficiency projects, investing where private sector investors are not willing to invest. The CEFC has a \$10 billion budget over 5 years. Half of the CEFC's budget is set aside for investment in 'the commercialisation and deployment of renewable energy and enabling technologies'. The CEFC has so far invested \$500 million in projects worth \$2 billion. However, the Coalition Government plans to abolish the CEFC as part of its Direction Action policies.

At least one of these initiatives will support the increased take up of renewable energy, particularly for innovative technologies such as renewable gases from waste conversion and transportation technologies.

NSW RENEWABLE ENERGY ACTION PLAN

The NSW Renewable Energy Action Plan published in September 2013 seeks to provide a secure, affordable and renewable energy future for NSW.

NSW Government has developed the Renewable Energy Action Plan to guide NSW's renewable energy development and to support the national target of 20% renewable energy by 2020. The Plan positions NSW to increase energy from renewable sources at least cost to the energy consumer and with maximum benefits to NSW. The Plan's three key goals (comprising 24 actions) are:

- Attract renewable energy investment and projects
- Build community support for renewable energy
- Attract and grow expertise in renewable energy technology.

Key targets include facilitating five community renewable energy projects, promoting NSW as a leader of research and innovation in renewable energy, establishing a working group to develop an advanced bioenergy initiative and supporting research and development in advanced bioenergy applications and wave and tidal technologies.

The Plan is not inconsistent with the City of Sydney's Renewable Energy Master Plan and the City could assist NSW Government in achieving its objectives, particularly in addressing regulatory barriers to decentralised renewable energy, overcoming the intermittency of existing near commercial renewable energy technologies and the differences in approach that will be needed for cities and rural areas.

2.

3.

4.

5.

6.

³ The London Plan 2008 Chapter 4A Climate Change and London's Metabolism: Mitigation of and Adaptation to Climate Change and Using and Managing Natural Resources <http://www.london.gov.uk/thelondonplan/docs/londonplan08.pdf>

⁴ Australian Government Department of Climate Change and Energy Efficiency Inclusion of Energy Generation in Building Energy Efficiency Standards 2012 <http://www.climatechange.gov.au/~media/publications/nbf/inclusion-of-energy-generation-in-building-energy-efficiency-standards-pdf.pdf>

RENEWABLE ENERGY JOBS, EDUCATION AND TRAINING

Global demand for renewable energy continued to rise during 2011 and 2012, supplying an estimated 19% of global final energy consumption. Total renewable electricity capacity worldwide exceeded 1,470GW in 2012, up by 8.5% from 2011. Renewables made up just over 50% of net additions to electric generating capacity from all sources in 2012. Top countries for renewable electricity capacity were China, USA, Germany, Japan, Spain, Italy and India.

In the European Union, renewables accounted for almost 70% of additions to electricity generation capacity in 2012. Renewable gas has also grown significantly, especially in Europe where almost 12,000 renewable gas plants operated in 12 countries, mainly supplying cogeneration/trigeneration networks. In addition, 2,250 sewage treatment plants are also operating in Europe with a growing proportion of renewable gas grid injection for cogeneration/trigeneration and transport.

An estimated 5.7 million people worldwide work directly or indirectly in the renewable energy sector. China is the world leader with 1.75 million people employed in the renewable energy sector followed by the European Union (1.2 million), Brazil (0.8 million), USA (0.6 million), India (0.4 million) and Germany (0.4 million).

In Australia, there are 1,340 companies operating in the renewable and clean energy sector, employing 53,000 people. In NSW, 427 companies are operating in the renewable and clean energy sector, employing 20,600 people. However, the potential for the renewable energy sector and associated jobs in both Australia and NSW is vast and the sector is currently nowhere near as big as it could be if Australia was to tap into its immense renewable energy resources.

In order to capitalise on the growing renewable energy industry in Australia and NSW it is important that universities and TAFEs provide the courses for Australians to skill themselves for renewable energy technologies and installations, particularly with emerging new renewable energy technologies such as renewable gas grid injection, 'power to gas', geothermal and ocean renewable energy. Sydney, in particular, could become a centre of renewable energy excellence with sister cities such as Newcastle and Wollongong also taking advantage of this. '

COMMUNITY RENEWABLE ENERGY

What can the community do to support the City's Renewable Energy Master Plan and help the City move toward a 100% renewable energy system by 2030? Much of the City's renewable energy target inside the City's LGA is solar, some 478MW out of the 534.5MW of installed capacity primarily from solar PV and solar thermal hot water displacing grid electricity. The City's renewable electricity target beyond the City's LGA is 170MW, primarily onshore wind energy but could also be other forms of renewable energy. In addition to that is the City's renewable gas target replacing 100% of projected natural gas consumption in the city by 2030. How can the community help the City to deliver these targets?

The community can help the City by advocating, proselytising and lobbying governments to remove regulatory barriers to decentralised renewable energy and by installing their own renewable energy installations where they are able to do so. However, many residents and businesses in the city who want to contribute toward making Sydney a 100% renewable energy city are currently not able to do so because they do not own the buildings that they occupy, do not have unshaded roofs or do not own roofs at all in multi-occupied buildings or do not have the finance to install renewable energy generation. How can the City help its community to help the City in delivering this Renewable Energy Master Plan?

As part of its research into world renewable energy best practice a key component of how countries were delivering such a large proportion of renewable energy generation was community renewable energy. In Denmark, nearly 50% of domestic electricity demand and 80% of thermal energy demand (heating and cooling) is owned by the customers themselves in one form or the other. In Copenhagen, the Middlegrunden wind farm in Copenhagen Harbour is 50% owned by a community cooperative with 8,650 residential members living within 2km of the wind farm.

In Germany, 65% renewable energy generation, some 35,000MW, is owned by the customers themselves either as individuals or as cooperatives. The rapid roll out of renewable energy in Germany is now nearly three times the installed nuclear capacity in 2010 and five times installed nuclear capacity in 2011 (after Germany's nuclear phase-out decision). Even in the UK, there has been a rapid growth in community owned self-generation from 6% in 2011 to 15% in 2013.

1 RENEWABLE ENERGY RESOURCES

2 RE-THINKING RENEWABLE ENERGY

3 RENEWABLE ENERGY FOR THE CITY OF SYDNEY

4 PERFORMANCE MEASURES

5 ENABLING THE MASTER PLAN

6 CASE STUDIES

1.

2.

3.

4.

5.

6.

WHAT IS COMMUNITY ENERGY?

Community renewable energy generally means locally owned, locally sited renewable energy (electricity and/or heat and/or gas). Community renewable energy includes the engagement or participation by the community that reaches beyond a simple investment or shareholding relationship. It also goes beyond the community benefit model sometimes used by developers where a small percentage of the income from a private development is set aside for a community benefit such as a new community facility. Community energy also includes some form of control by community owners of the project, through a cooperative or as a landowner or groups of landowners, as small and medium enterprises, or as residents and homeowners who live and work with the installation daily.

Community renewable energy projects provide economic, environmental and social benefits such as increasing the local economy, creating local jobs, reducing dependency on fossil fuels and high grid network charges, reducing greenhouse gas emissions and climate change impacts, reducing fossil fuel pollutant emissions and associated pollutant related illnesses, providing opportunities for local participation and capacity building in local communities, building greater acceptance and interest in renewable energy, giving voice to people's enthusiasm and interest in renewable energy and providing a symbol of the community as a source of pride and identity.

The following section provides a summary of community renewable energy models used around the world. Other models may be viable currently or within the timeframe of this Master Plan.

COMMUNITY OWNED RENEWABLE ENERGY

Community owned renewable energy is owned or partly owned by the local community. Projects are financed by the community purchasing shares in the project as members of a cooperative for which they receive dividends for the shareholding investments. Members are normally required to be active members, which mean that they must also purchase and consume the renewable energy generated directly or indirectly by the cooperative to make the project financially viable to lenders.

In Denmark, renewable energy developers must sell 50% of the shareholding in the project to residents living within 2km of the project by law, and it is this legislation and community owned model that has led to Denmark being a world leader in renewable energy and not because Danes are any greener than anyone else. More than 150,000 households are co-owners of local wind farm co-operatives, which have installed 86% of all wind turbines in Denmark.

In Germany, hundreds of thousands of people have invested in citizen's wind farms across the country representing 90% of wind farms in some states such as North Frisia. The sector employs more than 90,000 people and generates 8% of Germany's electricity.

The first community owned renewable energy scheme in the UK was the Baywind wind farm in Cumbria owned by 1,300 members which became operational in 1997. Today there are 43 community owned renewable energy schemes operating in the UK. The first community owned solar farm in the UK was the Westmill solar park adjoining the community owned Westmill wind farm on the Wiltshire/Oxfordshire border. The solar farm became operational in 2011 after raising £6 million from 1,650 members. The share issue was 50% over subscribed.

Community wind is one of the fastest growing markets in the USA with 27 states having legislation that allows community renewable energy schemes. Today, there are more than 1,500 wind farms owned by farmers, ranchers, landowners, consumer-owned utilities, school districts, universities and native tribes. The largest concentration of community owned wind farms are in Minnesota (469), Washington (440), California (238), Nebraska (153), Iowa (81) and Texas (51).

The first community owned renewable energy scheme in Australia was the Hepburn wind farm in Victoria owned by 2,300 members which became operational in 2011.

1 RENEWABLE ENERGY RESOURCES

2 RE-THINKING RENEWABLE ENERGY

3 RENEWABLE ENERGY FOR THE CITY OF SYDNEY

4 PERFORMANCE MEASURES

5 ENABLING THE MASTER PLAN

6 CASE STUDIES

THIRD PARTY OWNERSHIP

Third party ownership models allow homeowners to contract with third party ownership companies, solar leasing companies or solar finance companies to have, for example, solar PV installed on their rooftops. The companies are responsible for financing, permitting, designing, installing and maintaining the system. Contracts between the homeowner and solar leasing company takes one of two forms:

- Power Purchase Agreement (PPA) option – where the homeowner buys all of the electricity produced by the solar PV on a long term PPA (up to 20 years) at an agreed price which is normally lower than or competitive with the grid retail price of electricity.
- Lease option – where the homeowner makes pre-established monthly payments to the solar leasing company. The payment is not tied to the solar PV actual output but is calculated to be competitive with the homeowner's existing electricity bill.

The contract models normally offer a buyout option allowing homeowners to eventually purchase their own solar PV system.

In California, third parties own more than two thirds of residential renewable energy installations in the California Solar Initiative.

ENERGY SERVICES MODEL

The energy services model works on the principle that customers do not want to purchase energy but energy services to run their heating, cooling, lighting and power. Energy services are normally provided with decentralised energy or distributed generation in conjunction with energy efficiency. The energy services model is an established model previously based on cogeneration or trigeneration and energy efficiency but in recent years has adapted to include renewable energy generation.

Energy Services Companies (ESCOs) provide the energy services or an ESCO is established by the customers, such as a body corporate, themselves. There are three distinct types of energy services model:

- Facilities management or energy performance contracting model for the industrial and commercial sector
- Community energy model for groups of customers at the same location such as social housing or local authority schemes
- Household model where ESCOs provide energy services paid for by the savings in energy consumption and costs.

ESCOs normally operate under an exempt licencing regime over private wire networks or have stripped down retail electricity licences operating over local public wires on the virtual private wire principle to enable export of surplus power traded within their customer base to maintain the economic value of the renewable energy generated rather than exporting to the grid.

The US ESCO market is the largest in the world growing at an annual growth rate of between 10-25%. US ESCOs generate \$4.1 billion of revenue a year of which on site renewable energy generation accounts for 14% (\$570 million). Germany is Europe's largest ESCO market, valued at between €1.7 and 2.4 billion a year, with approximately up to 500 ESCOs operating in Germany. France has the oldest ESCO market originally developed in the 19th century with approximately 100 ESCOs operating in France today. In the UK, the ESCO market is worth about £700 million a year.

LANDOWNER POOLS

Landowner pools are distinctive renewable energy projects where several landowners with adjacent land pool their land to maximise the use of natural resources and to compensate all affected landowners. Each pool develops a formula based on the amount of land they bring to the project. For wind energy projects, this will include the number of turbines erected on their land, the length of any road, grid connection or transformer station on their land. This model has the advantage of avoiding 'turbine envy' where one landowner installs the wind turbines first, arraying them in such a way on the boundary of their land that the neighbouring landowner cannot erect their own turbines, has to view the wind turbines but received no benefit from the installation.

Landowner pools for renewable energy projects very often make use of existing landowner pools for farming and agriculture and are popular in Germany and Canada. In Germany, the output from landowner pool renewable energy projects such as wind and solar farms and renewable gas (from farm waste) grid injection projects is normally sold, after local energy use, to the nearest city decentralised energy network and/or transport refuelling stations, not the electricity grid.

1.

2.

3.

4.

5.

6.

MUNICIPAL OWNED RENEWABLE ENERGY

Municipal owned renewable energy works on the ‘show by doing’ principle where the municipality or local authority invests in and owns renewable energy to reduce greenhouse gas emissions and energy bills to the benefit of local ratepayers. Municipal owned renewable energy also acts as a source of pride for local residents and businesses and acts as a beacon for others in the municipality to replicate what the municipality has done and so achieve a far higher level of investment in renewable energy in the locality than would have been possible without municipal owned renewable energy schemes. One of the first examples in the USA was the municipal owned wind turbine in Boston Harbour, Massachusetts which became operational in 2001.

In Germany, municipalities play a significant role in developing and promoting renewable energy as part of the ‘100% Renewable Energy Regions’ networking project. Today, there are 120 municipalities and regions working to deliver a 100% renewable energy supply for their municipalities and regions. Taking renewable electricity, heat and gas into account 10 municipalities have already achieved or exceeded the 100% renewable energy target ranging from Emsland, Lower Saxony with 103% renewable energy to Prignitz, Brandenburg with 248% renewable energy.

These are rural and small urban German municipalities. Major cities are more challenging. However, the recent German elections included a referendum for the City of Hamburg to buy the local electricity distribution network from the private utility and turn it into a local municipal-based public utility to develop affordable renewable energy without the barrier of high network charges. Hamburg won the referendum despite a well-funded opposition to the proposal from private utilities and state government and points the way for other major cities in Germany to follow.

Similar municipal owned renewable energy projects have been developed around the world, including the municipal owned projects at Woking Borough Council and the Greater London Authority in the UK and at the City of Sydney, Australia.

STATE SHARED RENEWABLE ENERGY PROGRAMS

Shared renewable energy programs enable tenants, schools, cities and many other interested parties not able to invest in their own renewable energy projects to invest in state run renewable energy projects.

Similar to community owned renewable energy, in addition to purchasing a share in a new nominated renewable energy project for which they receive a dividend on their investment the community shareholder must also purchase the renewable energy produced.

In California, the State Legislature has passed Bill SB 43 which will allow millions of Californians who cannot install their own renewable energy to invest in and obtain renewable energy through their utility. The ruling allows the investment of up to 600MW in renewable energy, of which 100MW must be made available to residential customers. Climate change and solar energy pressure group The Vote Solar Initiative estimates that the initial offering will enable more than 20,000 residential ratepayers throughout California, each purchasing an average 5kW share, will be able to participate in the program, as well as local schools, businesses, the military and government.

State shared renewable energy programs are not the same as diffuse Green Power or green tariff schemes in that customers of shared renewable energy schemes not only purchase renewable energy from a specific new renewable energy project they also own a part of the renewable energy project. The Californian program requires state utilities to deal directly with renewable energy developers, managing the rates on behalf of customers, and provides state utilities with the ability to respond to the erosion of their share of the retail energy market by community owned renewable energy.

LOW CARBON INFRASTRUCTURE ZONES AND 'HOT SPOTS'

The Trigeneration Master Plan targeted specific areas in the city that have high energy demand loads. The areas covered are referred to as Low Carbon Infrastructure Zones.

These zones would be supplied by low carbon energy via a new thermal energy network using waste heat from local electricity generation. The waste heat can be used to heat or cool buildings and would significantly reduce peak electricity loads and the need for network upgrades, augmentation and expensive peaking plant which is required to provide peak power for just a few hours a year when peak loads arise.

FIGURE 13: LOW CARBON INFRASTRUCTURE ZONES AND 'HOT SPOTS' (SOURCE: KINESIS)

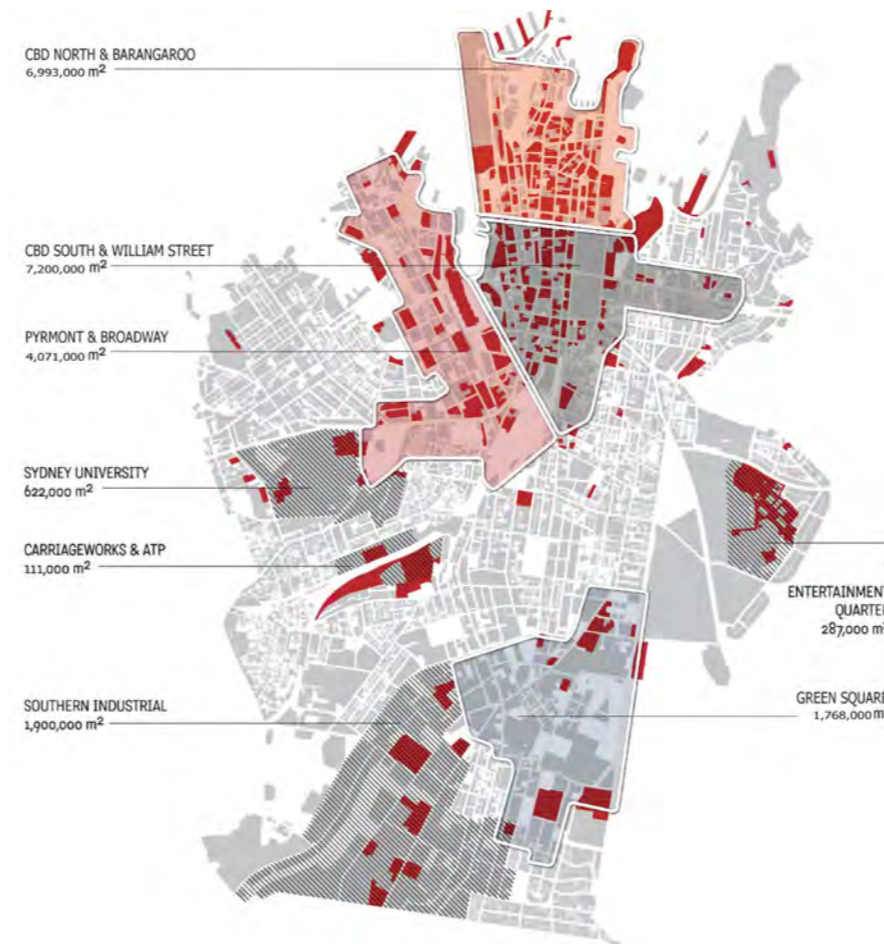

Buildings in low carbon zones that connect to a thermal energy reticulation network can reduce their greenhouse gas emissions by between 40–60%. Solar photovoltaics and other local renewable electricity would complement the planned trigeneration network. The proposed thermal energy reticulation network could also be used to transport geothermal hot water and precinct scale solar water heating.

Areas outside the Low Carbon Infrastructure Zones and 'Hot Spots' are better suited to stand alone or small scale precinct solutions such as solar PV, solar hot water, small scale and micro turbine wind energy technologies installed on a building by building or small scale precinct network basis. This does not preclude the possibility of additional zero or low carbon solutions for areas outside these zones and 'hot spots' in the future, particularly where a significant renewable energy resource is available.

1 RENEWABLE ENERGY RESOURCES

2 RE-THINKING RENEWABLE ENERGY

3 RENEWABLE ENERGY FOR THE CITY OF SYDNEY

4 PERFORMANCE MEASURES

5 ENABLING THE MASTER PLAN

6 CASE STUDIES

1.

2.

3.

4.

5.

6.

INTEGRATED 100% RENEWABLE ENERGY SYSTEM

In developing this Renewable Energy Master Plan detailed research was undertaken into world renewable energy best practice, the mix of renewable energy resources and technologies deployed and in particular, how other countries were overcoming the intermittency of renewable energy generation in their move towards a 100% renewable energy future, particularly in Europe, which is currently far ahead of Australia in terms of climate change and renewable energy targets and delivery. The European renewable energy model is also acting as a model for the US and Asian economies as countries seek to become energy independent and reduce their emissions.

The integrated smart grid system being developed by advanced economies in Europe shows how electricity, heat and gas can be integrated to provide a 100% non-intermittent renewable energy system. Renewable gas developed from waste converted into substitute natural gas and injected into the gas grid, the use of 'power to gas' technologies for surplus renewable electricity from intermittent renewable electricity generation technologies such as solar and wind converted into renewable hydrogen or renewable gas and injected into the gas grid and heat recovered from decentralised electricity generation for supplying heating and cooling are key features of such a system.

A key reason why renewable electricity is converted into renewable hydrogen or renewable gas for injection into the gas grid is that transporting electricity is 20 times more expensive than transporting the same amount of energy via a gas pipeline⁵. Existing gas grids also automatically provide low cost energy storage for renewable electricity and gas pipelines are buried underground and not exposed to high winds, storms or cyclones providing a significant contribution to security of supply and climate change adaptation.

⁵ Marcogaz Technical Association of the European Natural Gas Industry 'Power2Gas' Fact Sheet http://www.gasnaturally.eu/uploads/Modules/Publications/marcogaz_power2gas_fact_sheet.pdf

- 1 RENEWABLE ENERGY RESOURCES
- 2 RE-THINKING RENEWABLE ENERGY
- 3 RENEWABLE ENERGY FOR THE CITY OF SYDNEY
- 4 PERFORMANCE MEASURES
- 5 ENABLING THE MASTER PLAN
- 6 CASE STUDIES

FIGURE 14: HOW RENEWABLE ELECTRICITY, HEAT AND GAS CAN BE INTEGRATED TO PROVIDE A 100% NON-INTERMITTENT RENEWABLE ENERGY SYSTEM (SOURCE: CITY OF SYDNEY)

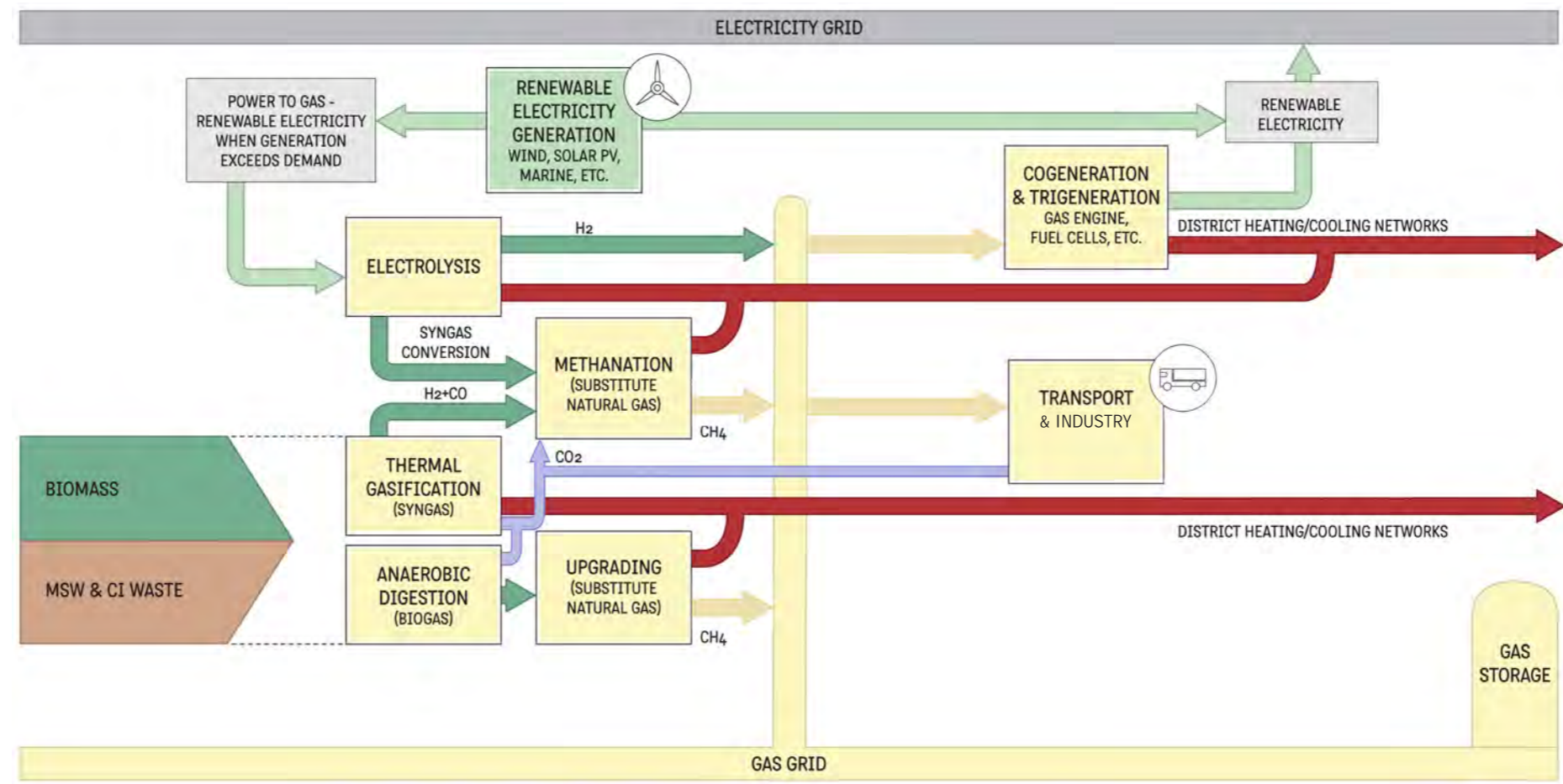



- 1.
- 2.
- 3.
- 4.
- 5.
- 6.

RENEWABLE ENERGY FOR THE CITY OF SYDNEY

RENEWABLE ENERGY FOR THE CITY OF SYDNEY

Converting widely available and naturally occurring renewable energy into fuel for buildings and sourcing renewable gases from waste for trigeneration and decentralised thermal energy networks is not new elsewhere around the world but is a new model for existing and new development in Australia.

The shift to renewable energy in cities is a challenge for urban planners, particularly, in retrofitting buildings and changing land use.

For Sydney, this shift will not be a simple case of installing technology, but a shift in mindset to becoming an innovative and progressive sustainable Australian city.

A self sufficient 'renewable energy city' becomes part of the ecosystem of how a sustainable city functions. Part of the challenge is socially acceptable renewable energy technologies in urban environments.

Accommodating renewable energy within the built form of the city is a challenge to be overcome. Each technology will have particular land use constraints, such as proximity to sensitive land uses, unfavourable topography, conflict with other land uses, or requirements in the low carbon zone thermal energy networks.

Furthermore, Sydney has less suitable physical climatic conditions, less land available, urban form restrictions, and fewer resources to tap into for conventional renewable energy technologies such as solar and wind than in regional areas of NSW. This impacts the technical performance and the suitability of some renewable energy technologies.

Large scale introduction of new building technologies and power plants within urban environments is constrained by:

- Complexity of the built form.
- Availability of suitable land uses.
- Planning conditions.
- Current energy pricing structure.
- Community preference.
- Regulatory barriers to decentralised energy

However, less conventional renewable energy technologies and resources such as sourcing renewable gas and renewable thermal energy in underground pipes can overcome urban environment constraints.

WHAT IS THIS MASTER PLAN PROPOSING?

The Renewable Energy Master Plan sets out the size and availability of renewable energy resources needed to meet the City of Sydney LGA energy and climate change targets and the potential investment required.

The first objective is to determine how much of the City's 30% renewable electricity target could come from within the local government area, and, where there is a shortfall, to determine the amount of renewable electricity to be sourced from beyond but within proximity of the city to meet the target.

The second objective is to determine whether there is enough renewable gas resource to replace natural gas to supply a trigeneration network. This objective is more challenging but is in addition to the renewable electricity target.

RENEWABLE ELECTRICITY TARGET

Sustainable Sydney 2030 estimated the City of Sydney LGA electricity consumption by 2030 on a business as usual (BAU) basis, taking account of growth, as 5,087GWh/year. This 2030 electricity consumption has been re-calculated by Kinesis as 4,564GWh/year using current kWh/m² for the 12 different building types multiplied by the improved projected floor space for each building type across the City of Sydney LGA.

The 2030 BAU electricity consumption would be reduced by building energy efficiency retrofits, the reduction in electricity demand for electric air conditioning chillers displaced by trigeneration and other measures such as LED street lighting and improved standards in the Minimum Energy Performance Standards (MEPS) to 3,904GWh/year.

Therefore, the City of Sydney LGA renewable electricity target is 30% of 3,904GWh/year which equates to 1,171GWh/year by 2030. However, 1,300GWh/year of renewable electricity was modelled for this Master Plan which equates to 33% of the City of Sydney LGA electricity requirements being met by renewable electricity by 2030. This will provide some buffer in delivering the 30% renewable electricity target.

RENEWABLE GAS TARGET

The Council of the City of Sydney made a resolution on 18 June 2012 that by 2030 renewable gases from waste and other renewable energy sources such as geothermal heat will replace fossil fuel natural gas in the proposed trigeneration systems enabling them to provide carbon free electricity as well as carbon free thermal energy for heating and cooling in addition to the City's 30% renewable electricity target.

Taken together, the renewable electricity and renewable gas for trigeneration targets would deliver a 100% renewable energy system for the City of Sydney LGA by 2030.

1 RENEWABLE ENERGY RESOURCES

2 RE-THINKING RENEWABLE ENERGY

3 RENEWABLE ENERGY FOR THE CITY OF SYDNEY

4 PERFORMANCE MEASURES

5 ENABLING THE MASTER PLAN

6 CASE STUDIES

1

BUILDING SCALE RENEWABLE ELECTRICITY AND HEAT WITHIN THE CITY OF SYDNEY LGA

The following sections identify where renewable energy resources are optimal for specific technologies to operate efficiently based on resource assessments developed by Arup and Talent With Energy for the City of Sydney. This comprises:

1. Building Scale Renewable Electricity & Heat within the City of Sydney LGA.
2. Precinct Scale Renewable Electricity & Heat within the City Of Sydney LGA.
3. Utility Scale Renewable Electricity Beyond the City Of Sydney LGA.
4. Renewable Gases from Waste and Biomass Within and Beyond the City Of Sydney LGA.

By 2030, building scale renewable energy using today's technologies could generate or displace more than 15% of the City of Sydney LGA electricity demand.

Buildings with small scale renewable electricity and thermal energy technologies are generally designed to meet their own energy demand, that is, consuming the renewable electricity and heat within the building itself.

Surplus electricity can be exported to the distribution network. Importantly, the generation of its own local renewable energy means that the building will avoid using fossil fuel grid electricity during these times and paying high electricity network charges.

The technologies considered most appropriate for residential and non-residential buildings are:

1. Solar thermal hot water collectors.
2. Solar PV electricity.
3. Building integrated wind turbines.
4. Building scale micro wind turbines.
5. Renewably fuelled co/trigeneration.

Different renewable technologies are suitable for different buildings according to their energy profile and type of building. This will be explained for residential, commercial and industrial buildings.

BUILDING HIERARCHY

To develop this Master Plan a hierarchy was developed to allocate roof space for different renewable energy types and optimise energy output.

This hierarchy is applied to commercial, residential and industrial buildings across the city to determine the total renewable energy generation capacity and the carbon reduction potential. This will help prioritise which technologies should be installed on buildings to achieve the maximum cost effectiveness.

The hierarchy initially identifies if the building is located within one of the Low Carbon Infrastructure Zones or 'Hot Spots'. If it is, then solar PVs should be installed on the entire building roof space as the thermal energy and supplementary electricity demands of the building would

be met by the proposed trigeneration network. This will avoid technologies competing with each other.

If the building is outside a Low Carbon Infrastructure Zone or 'Hot Spot', the hierarchy will aim to meet the thermal energy demand through solar hot water technologies installed on the roof. If the building is over 150 meters in height, the roof space should be used for solar PV or hot water technology and small scale or micro wind turbines. If the building is not over 150m, the roof space should install solar PV and/or hot water only. Small scale and micro wind turbines are less effective on low rise residential buildings and may not operate at all.

The maps in this section show locations where renewable energy resources are optimal for specific technologies to operate efficiently. Results show theoretical maximum potential, not planned installations.

COMMERCIAL BUILDINGS

Commercial buildings include retail, entertainment, accommodation and commercial office buildings.

Commercial buildings have a number of opportunities for renewable energy generation; however commercial building stock is both large and varied in size, age, use and location. As such, not all technologies listed will be applicable to every commercial building in the City of Sydney based on their performance.

Multi-storey commercial buildings have a limited roof space to energy demand ratio. The majority of commercial buildings can only meet a small portion of their total thermal and electrical demand with renewable energy technology. Typically, only single storey retail and education buildings have the opportunity to meet demand.

The main proportion of energy currently supplied to commercial buildings is electricity used for cooling. However, a commercial building can increase the proportion of renewable electricity to electrical demand by replacing electric air conditioning, heating and hot water services with thermal energy technologies. Gas demand is lower in commercial buildings and mainly used for heating during the winter period and for hot water services.

RESIDENTIAL BUILDINGS

Residential buildings include single dwellings and multi-unit buildings that typically have a relatively large roof

space area available for renewable energy technologies and relatively low energy consumption.

Single level residential dwellings may have a significant opportunity to offset their entire building energy demand, as well as to export electricity to the local distribution network.

Multi-unit residential buildings are traditionally space poor, with little roof space or plant room space. Likewise, reticulation space for hot water systems is typically very tight, compounding issues for solar hot water and heat pump solutions.

Residential buildings in Sydney use nearly equal proportions of both gas and electricity. For households with electric hot water systems, the main use of electricity is for heating hot water.

1.

2.

3.

4.

5.

6.

1 RENEWABLE ENERGY RESOURCES

2 RE-THINKING RENEWABLE ENERGY

3 RENEWABLE ENERGY FOR THE CITY OF SYDNEY

4 PERFORMANCE MEASURES

5 ENABLING THE MASTER PLAN

6 CASE STUDIES

INDUSTRIAL BUILDINGS

The majority of industrial buildings have large, flat vacant roof space suitable to accommodate solar technologies for electricity and hot water.

In general, industrial buildings contain relatively large open spaces, often with some smaller air conditioned office space. Thermal loads are low on a per square meter basis compared with other building typologies.

Electricity is predominantly used for hot water heating. Parts of the City of Sydney LGA contain industrial buildings with high energy consumption, typically steam for heating and cooling processes. These may be ideal for local or precinct-based cogeneration or trigeneration supplemented by solar PV.

Concentrated photovoltaics (CPV) are potentially of a size that would make this technology more viable on the big roofs of industrial buildings. Roof mounting may be an issue for lightweight structures.

There are opportunities for third party or energy services companies to use the large roof spaces in industrial buildings to generate renewable energy as a commercial precinct scale facility for electricity export into the local distribution network to supply other buildings.

There are no industrial buildings of sufficient height to access the wind speeds that small scale or micro wind turbines need to operate or compete favourably with solar technologies based on equivalent roof areas.

FIGURE 15: POTENTIAL BUILDINGS FOR SOLAR THERMAL HOT WATER (SOURCE: ARUP)

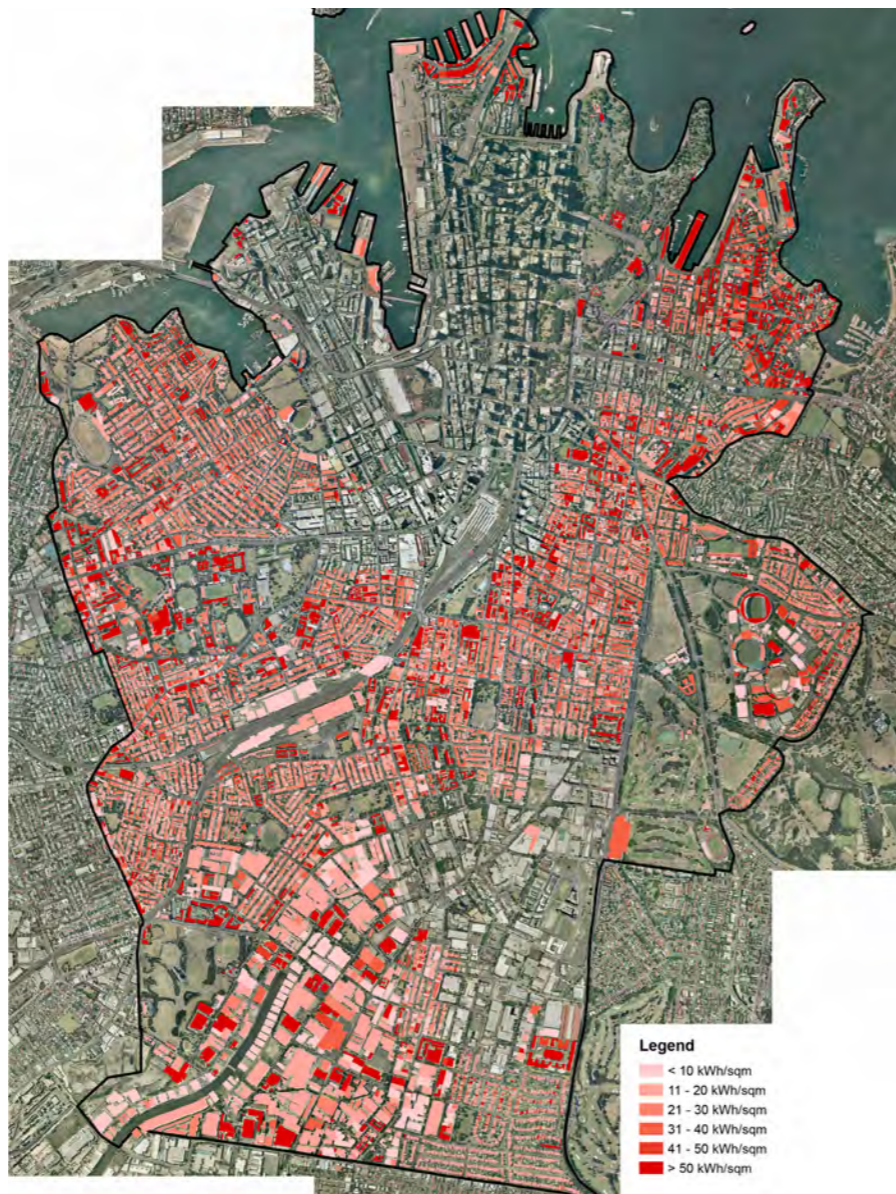

SOLAR HOT WATER

Installed capacity	62 MW
Grid electricity offset	138 GWh/year
Roof area required	19 ha
Percentage of total roof area	2.8%
Carbon emissions reduction by 2030	1.8%
Contribution to electricity by 2030	3.1%
Household size installations	44,645
Equivalent average households electricity/year	30,829

Solar hot water systems can make a significant contribution to reducing greenhouse gas emissions. The aim is to install solar hot water in areas outside the Low Carbon Infrastructure Zones and 'Hot Spots' as the thermal energy requirements could be met by a trigeneration network. The cost of solar hot water technology is lower than solar PV and is cost effective where it avoids fossil fuel grid electricity. With subsidies, solar hot water provides a return on investment with a net benefit per tonne of carbon.

Solar hot water should replace electric hot water systems across all building types.

Roof spaces that receive greater than 50% direct sunlight over a month are shown on the following map.

1.

2.

3.

4.

5.

6.

FIGURE 16: POTENTIAL BUILDINGS FOR SOLAR PV (SOURCE: ARUP)

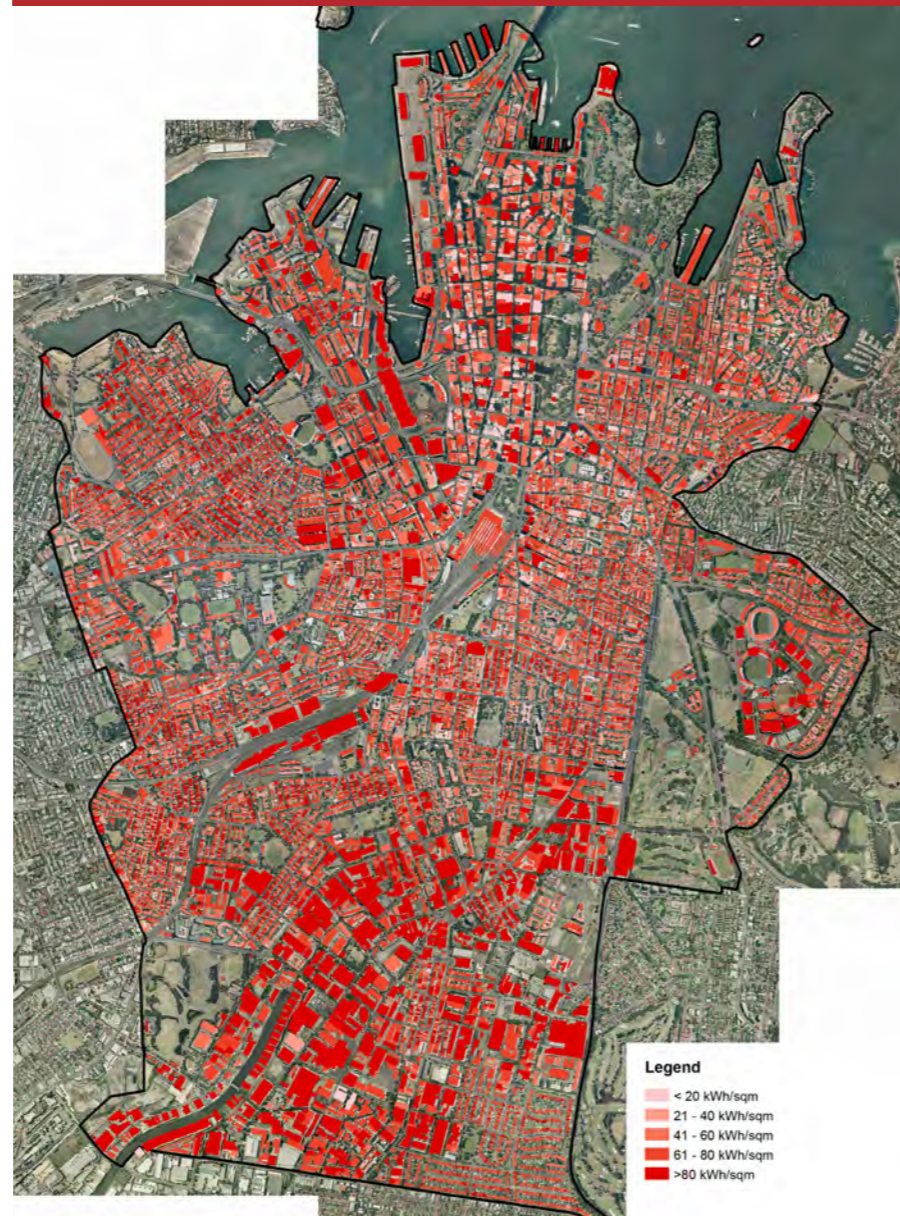

SOLAR PHOTOVOLTAIC PANELS

Installed capacity	395 MW
Grid electricity offset	455 GWh/year
Roof area required	49.3 ha
Percentage of total roof area	7.3%
Carbon emissions reduction by 2030	5.8%
Contribution to electricity by 2030	10.1%
Number of PV panels	768,889
Equivalent average households electricity/year	101,264

Solar PV could supply more than 10% of the city's electricity and significantly reduce peak and shoulder loads in summer. There is significant potential to install panels on roofs, particularly on the large industrial flat roofs in the south of the city.

With the current regulatory barriers to decentralised renewable energy solar PV installations should be sized to meet the energy demand of the particular building unless part of a precinct scale scheme.

Solar PV has the greatest capacity for renewable electricity generation per square metre. It can operate at or near capacity roughly during peak and shoulder times during daylight hours. Solar renewable energy generated in situ will reduce some of the impact of peak demand on the grid and make a significant contribution to reducing carbon emissions. In 2010/11, 32% of the rated capacity of solar PV installations was effective at the time of the overall peak demand seen by the electricity network between 16:30-17:00. Since then, Australia has passed the 1 million mark for solar PV installations with nearly 250,000 solar PV installations in NSW reducing NSW's residential peak electricity demand by approximately one third of the rated capacity. In Ausgrid's electricity distribution network area which also serves the City of Sydney LGA, 72,000 solar PV installations have so far been connected with Ausgrid confirming that robust urban networks, such as the City of Sydney LGA, can accept high levels of solar PV without causing significant technical problems.

West facing solar PV will have a greater impact in reducing electricity peak demand than North facing solar PV but generate less solar electricity annually. The building hierarchy assigns the majority of the roof space to accommodate solar PV, owing to the introduction of the planned trigeneration thermal energy network.

1 RENEWABLE ENERGY RESOURCES

2 RE-THINKING RENEWABLE ENERGY

3 RENEWABLE ENERGY FOR THE CITY OF SYDNEY

4 PERFORMANCE MEASURES

5 ENABLING THE MASTER PLAN

6 CASE STUDIES

FIGURE 17: POTENTIAL BUILDINGS FOR SMALL WIND TURBINES (SOURCE: ARUP)



SMALL SCALE AND MICRO WIND TURBINES

Installed capacity	0.5 MW
Grid electricity offset	1 GWh/year
Roof area required	0.1 ha
Percentage of total roof area	0.02%
Carbon emissions reduction by 2030	5.8%
Contribution to electricity by 2030	0.02%
Installations	100
Equivalent average households electricity/year	156

Wind speeds for optimal generation are typically found on buildings higher than 100 m. While small or micro wind turbines can be installed to smaller buildings and in parks, the wind speeds are lower. Given that there are a relatively small number of very tall buildings in the city the total potential of small or micro wind turbines toward the City's renewable energy and emission reduction targets is lower than for other technologies

Small and micro wind turbines can be a cost effective option. However wind conditions within the City of Sydney are less than optimal. On the few buildings in the city at 150 m or above, small or micro wind technology will perform better than solar photovoltaic.

2

PRECINCT SCALE RENEWABLE ELECTRICITY AND HEAT WITHIN THE CITY OF SYDNEY LGA

By 2030, renewable energy plants within the City of Sydney LGA using today's technologies could generate or displace up to nearly 3% of the City of Sydney LGA electricity demand.

Precinct scale technologies would generate electricity and thermal energy from the city's resource base and be designed to export electricity to the distribution network supplying the city.

Precinct scale technologies need to be greater than 100 kW to achieve economies of scale and minimise capital costs. Large scale urban renewable electricity plants are generally located on low value land and in close proximity to local distribution network infrastructure.

A renewable electricity plant located within the City of Sydney that is connected to the local distribution network will avoid transmission charges altogether. Distribution network charges may be reduced where the plant provides a network benefit to the electricity distribution network service provider.

It may be challenging to integrate power plants into inner urban areas however precinct scale technologies have been introduced in other cities around the world with considerably higher density than Sydney.

There are significant benefits associated with locating renewable electricity plants within the city, including the capacity to control demand management, offset of transmission and distribution charges, and managing land use within the City's jurisdiction.

Precinct scale renewable energy technologies considered within the City of Sydney were:

1. Concentrated solar thermal.
2. Precinct scale wind turbines.
3. Direct use geothermal – circulating hot water

The maps in this section show locations where renewable energy resources are optimal for specific technologies to operate efficiently. Results show theoretical maximum potential, not planned installations.

CONCENTRATED SOLAR THERMAL

Installed capacity	21 MW
Grid electricity offset	47 GWh/year
Land area required	11.3 ha
Carbon emissions reduction by 2030	0.6%
Contribution to electricity by 2030	1%
Equivalent average households electricity/year	10,469

The minimum concentrated solar thermal or concentrated solar power plant size would be 500 kW to operate at medium efficiency. A buffer distance of 20 m is needed to avoid light pollution. Sites with a gradient greater than 1% are not suitable. Suitable areas include car park roof tops and industrial sites.

Concentrated solar thermal technology could generate a significant amount of renewable energy within the city. However, the majority of sites suitable to accommodate the technology are on valuable community land, such as parks. Concentrated solar PV is suitable at the utility power plants scale as it does not have the economies of scale at the building level. However, industrial roofs and industrial sites could play a large role in locating concentrated solar technologies.

Concentrated solar thermal plants can also export waste heat to the trigeneration thermal energy networks, which would contribute to carbon abatement and potentially provide financial returns.

1.

2.

3.

4.

5.

6.

1 RENEWABLE ENERGY RESOURCES

2 RE-THINKING RENEWABLE ENERGY

3 RENEWABLE ENERGY FOR THE CITY OF SYDNEY

4 PERFORMANCE MEASURES

5 ENABLING THE MASTER PLAN

6 CASE STUDIES

PRECINCT SCALE WIND TURBINES

Installed capacity	51 MW
Grid electricity offset	51 GWh/year
Land area required	16.9 ha
Carbon emissions reduction by 2030	0.6%
Contribution to electricity by 2030	1.1%
Number of installations	26
Equivalent average households electricity/year	11,360

Wind speeds are higher in the north and east of the city. However, larger areas of land are available in the south west of the city. A buffer distance from residential areas would be required.

Precinct scale wind turbines in urban areas are typically single or located in small clusters of two or three due to the physical constraints and buffer requirements.

Precinct scale wind turbines within the city may have less than optimum wind conditions compared with wind turbines in high wind speed areas of NSW. However the economic return is generally higher if network charges and losses are avoided.

The capital investment in wind turbines within the city in relation to its electrical output to reduce carbon emissions is higher than wind farm sites in remote regions of NSW. Wind energy in the city would however make an iconic statement that Sydney is moving towards a renewable energy future and set a precedent for Australia.

The spacing and buffer distances required by wind turbines means that only 5% of the local government area is theoretically suitable. Noise would also be less of an issue given the background noise of the city.

This Master Plan identifies resource potential for 51 megawatts of utility-scale wind turbines within the LGA, however the City has no plans to develop utility-scale wind turbines in the LGA. No sites have been identified or will be investigated, nor is private sector interest expected in the foreseeable future due to a combination of commercial, planning and community factors.

DIRECT USE GEOTHERMAL – CIRCULATING HOT WATER

Installed capacity	5 MW
Grid electricity offset	11 GWh/year
Land area required	0.1 ha
Carbon emissions reduction by 2030	0.1%
Contribution to electricity by 2030	0.2%
Equivalent average households electricity/year	2,383

Direct use geothermal technology, specifically circulating hot water, can be used in the trigeneration thermal energy network. The technology would need to be located on unused land or road reserves.

Direct use geothermal technologies can use the geothermal hot water to supply thermal energy for heating and cooling (via heat fired absorption chillers) applications within the city. Although geothermal contributions towards Sydney's targets are comparatively lower than the other technologies, the capital cost and carbon reduction potential of geothermal represents cost-effectiveness and geothermal requires the least amount of surface land use area. For large scale installations, circulating hot water systems can

complement the trigeneration thermal energy network and be injected straight into the trigeneration thermal energy network via heat exchangers.

Geothermal energy resources within the City of Sydney and surrounding area are not of sufficient temperature to generate electricity but are of sufficient temperature to inject into the trigeneration thermal energy network (98°C). Circulating hot water wells would complement the trigeneration thermal energy network, particularly during off peak thermal energy periods. Geothermal energy resources in the Sydney metropolitan area may be significantly greater than the area covered by the City of Sydney LGA, potentially rivalling Paris or Turin geothermal decentralised energy networks but further investigation will be needed.

Geothermal plants require little land area. One 1.2 MWth plant could be located within each of the Low Carbon Infrastructure Zones.

3

UTILITY SCALE RENEWABLE ELECTRICITY BEYOND THE CITY OF SYDNEY LGA

By 2030, renewable electricity plants beyond the City of Sydney LGA using today's technologies could generate at least 12% of the City of Sydney LGA electricity demand.

The City is intent on meeting as much as possible of its renewable electricity target from renewable energy located within the City of Sydney LGA. Any shortfall will need to come from within a reasonable proximity to the city.

This Master Plan estimates the amount of renewable electricity required from outside the City of Sydney LGA to be 468GWh per year by 2030, although 597GWh per year was modelled for this Master Plan. While this electricity is not being produced where it is required, the economics are typically improved due to lower land values and greater renewable energy resources.

Technologies operating beyond the city in optimum resource locations that could export electricity to Sydney include:

- 1 Onshore wind
- 2 Offshore wind
- 3 Geothermal electricity
- 4 Concentrated solar PV
- 5 Concentrating solar thermal
- 6 Wave
- 7 Tidal
- 8 Hydro

The following sections shows the amount of renewable electricity resources that would be required and are available in proximity to the City of Sydney to meet the 597GWh modelled required beyond the City to meet or exceed its renewable electricity target. These are therefore upper estimates as a portfolio of renewable electricity resources that are most likely to be available by 2030.

The most mature and near commercial of the utility scale renewable electricity technologies is onshore wind and this could generate enough renewable electricity within the 250km proximity area to provide the balance of the City's renewable electricity target. Therefore, for master planning purposes the balance of the City's renewable electricity target is based on large scale onshore wind energy.

However, any or all of the renewable electricity technologies identified in this section could provide the balance of the City's renewable electricity target or more by 2030, particularly if the intermittency of renewable electricity in the grid is to be overcome.

1.

2.

3.

4.

5.

6.

ONSHORE WIND

Installed capacity	220 MW
Annual output	597 GWh
Carbon emissions reduction by 2030	0.6%
Contribution to electricity by 2030	13.3%

Wind presents one of the greatest potential electricity generators by land use in NSW. Wind energy is one of the cheapest sources of renewable electricity on a commercial power plant scale.

The wind resource in NSW is sufficient to supply 100% of the city's electricity demands alone. However, relying on a single resource does not overcome the challenge of sourcing non-intermittency and spinning reserve back up.

FIGURE 18: POTENTIAL ZONES FOR ONSHORE WIND (SOURCE: ARUP)



OFFSHORE WIND

Installed capacity	270 MW
Annual output	597 GWh
Carbon emissions reduction by 2030	0.6%
Contribution to electricity by 2030	13.3% (Not assessed by Arup)
Land area required	6,000 ha

With new technologies, such as floating devices, offshore wind farms are no longer constrained to shallow water depths. Fixed offshore wind farms in NSW may be constrained by the cost of installing foundations at great depths on the sea floor.

Offshore wind farms benefit from stronger winds that are more constant, and have a lower cost of carbon abatement than onshore wind farms, as well as being less visible.

The following map shows the potential locations of ocean renewable energy offshore of NSW.

FIGURE 19: POTENTIAL ZONES FOR OFFSHORE WIND AND WAVE ENERGY (SOURCE: ARUP)



1 RENEWABLE ENERGY RESOURCES

2 RE-THINKING RENEWABLE ENERGY

3 RENEWABLE ENERGY FOR THE CITY OF SYDNEY

4 PERFORMANCE MEASURES

5 ENABLING THE MASTER PLAN

6 CASE STUDIES

- 1.
- 2.
- 3.
- 4.
- 5.
- 6.

GEOTHERMAL ELECTRICITY

Installed capacity	110 MW
Annual output	597 GWh
Carbon emissions reduction by 2030	0.6%
Contribution to electricity by 2030	13.3% (Not assessed by Arup)
Land area required	3 ha

There is significant potential for geothermal electric plants within NSW to supply electricity into the grid. Specifically there is known potential in the Hunter region, where sub surface temperatures are in excess of 200°C around 5km underground

The following map shows the locations under geothermal exploration licence in NSW, concentrated around Greater Metropolitan Sydney.

FIGURE 20: POTENTIAL ZONES FOR GEOTHERMAL ELECTRICITY (SOURCE: ARUP)

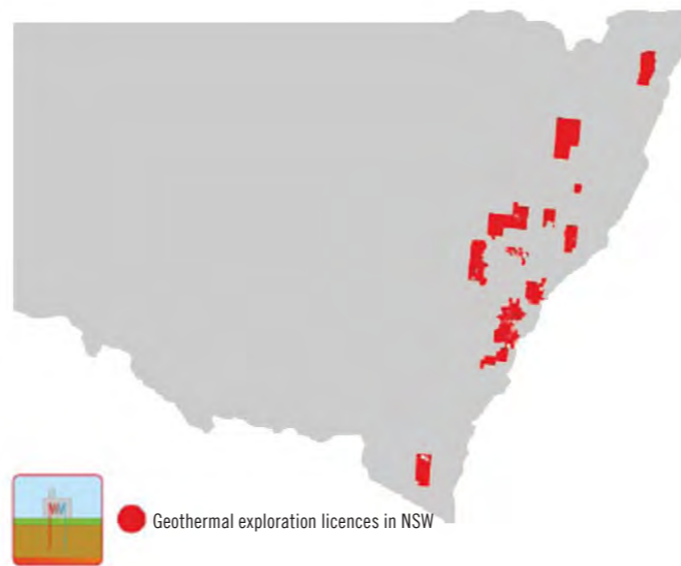

CONCENTRATED SOLAR PV

Installed capacity	290 MW
Annual output	597 GWh
Carbon emissions reduction by 2030	0.6%
Contribution to electricity by 2030	13.3% (Not assessed by Arup)
Land area required	732 ha

Much of NSW is not suitable for concentrated solar PV plants because of the distance to the transmission grid. Only one location is identified within 250km of Sydney.

FIGURE 21: POTENTIAL ZONES FOR CONCENTRATED SOLAR (SOURCE: ARUP)

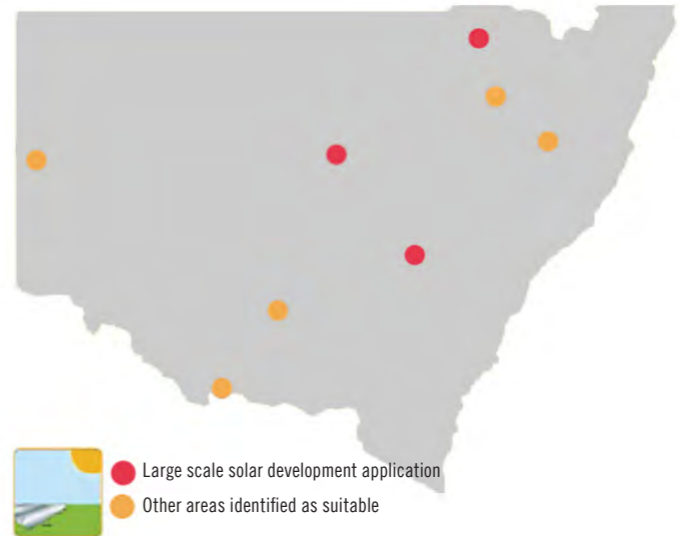

1 RENEWABLE ENERGY RESOURCES

2 RE-THINKING RENEWABLE ENERGY

3 RENEWABLE ENERGY FOR THE CITY OF SYDNEY

4 PERFORMANCE MEASURES

5 ENABLING THE MASTER PLAN

6 CASE STUDIES

CONCENTRATED SOLAR THERMAL

Installed capacity	290 MW
Annual output	597 GWh
Carbon emissions reduction by 2030	0.6%
Contribution to electricity by 2030	13.3% (Not assessed by Arup)
Land area required	732 ha

Concentrating solar thermal technologies, especially if combined with molten salt or other hot fluid thermal energy storage technologies have the advantage of reduced electricity generation intermittency supply and improved reliability of supply. Concentrated solar thermal has a slightly higher assumed capital investment than concentrated solar PV.

The previous map (Figure 21) shows various planning applications for large scale solar PV power plants in NSW received under the Australian Government's Solar Flagship program. These have good solar resources and access to transmission lines.

WAVE

Installed capacity	270 MW
Annual output	597 GWh
Carbon emissions reduction by 2030	0.6%
Contribution to electricity by 2030	13.3% (Not assessed by Arup)
Land area required	6,000 ha

Wave energy is currently costly, however analysis has shown it has potential to become cost-effective by 2030.

Wave resources in NSW are not as strong as in other states of Australia, and also highly dependent on the local area conditions. Wave energy is site specific and areas surrounding Sydney, including Nelson Bay and Port Kembla have been shown to have sufficient resources in excess of 30 kW/m. See map (Figure 19).

TIDAL

Installed capacity	270 MW
Annual output	597 GWh
Carbon emissions reduction by 2030	0.6%
Contribution to electricity by 2030	13.3% (Not assessed by Arup)
Land area required	6,000 ha

Tidal energy has more potential generation, in terms of area than offshore wind and wave power, but only in very large installations. Tidal and non tidal energy was not mapped for its potential resource capacity in this assessment. See map (Figure 19).

HYDRO

Installed capacity	270 MW
Annual output	597 GWh
Carbon emissions reduction by 2030	0.6%
Contribution to electricity by 2030	13.3% (Not assessed by Arup)
Land area required	6,000 ha

Hydro energy has the potential to be commercially viable. Hydro energy was not mapped for its potential resource capacity in this assessment.

4

RENEWABLE GASES FROM WASTE AND BIOMASS WITHIN AND BEYOND THE CITY OF SYDNEY LGA

The City of Sydney resolved on 18 June 2012 that by 2030 renewable gases from waste and other renewable energy sources such as geothermal will replace fossil fuel natural gas in the proposed trigeneration systems enabling them to provide carbon free electricity as well as carbon free thermal energy for heating and cooling.

City-wide or precinct scale trigeneration networks will provide development opportunities for renewable gases, particularly from waste, for supplying trigeneration in the City of Sydney LGA in the future, either by conversion and injection into the nearest natural gas pipeline and/or by direct connection to trigeneration energy centres.

Renewable gases from waste will generally take the form of a biogas generated by anaerobic digestion or a synthesis gas generated by advanced gasification and/or pyrolysis technologies. Other forms of renewable energy from other sources such as biofuels may also be incorporated.

Gases derived from organic waste can contribute more than 100% of renewable gas needs for the City's proposed trigeneration network. The renewable gas from waste would be sourced from within the city but would also need to be sourced within approximately 100–150km proximity of the city, although 250km was modelled.

Renewable gases can be converted into substitute natural gas that can displace natural gas in the proposed 372 MWe trigeneration decentralised energy network or the proposed full 477MWe of trigeneration and cogeneration or even the full trigeneration/cogeneration network and domestic gas used for domestic heating and cooking across the City of Sydney's LGA.

Current waste treatment and disposal is becoming increasingly more expensive and unsustainable with the increasing cost of the waste levy and a price on carbon which will make advanced waste treatment more attractive over time.

It is anticipated that the increasing cost of waste disposal will drive the renewable gas market to a point where advanced waste treatment technologies will become more economic and sustainable. Trends in the waste and

sewage industry show a clear shift towards renewable gas as a result of rising landfill costs.

Renewable gases can be derived from waste, including agricultural, horticultural, livestock manure, sewage, commercial, industrial and municipal waste and landfill.

In places where the City of Sydney has operational control, such as the City's own waste, the fuel conversion process will be able to be controlled by the City or its project partner(s) to maximise the renewable gas produced.

Advanced waste treatment technologies such as pyrolysis or gasification can convert 90% or more of the waste resource into renewable or synthesis gases.

Further emission reductions can be obtained if the renewable gases are treated at the source, rather than being transported into the city. These carbon reductions outweigh impacts associated with transporting the fuel as outlined in Chapter 4.

The physical properties of renewable gas are the determining factor for how the renewable gas is collected, which fuel conversion technology is most suitable, the fuel transportation technology used and how much energy can be harvested.

With advanced gasification processes now fully mature, the trend worldwide is to use energy from waste for gas production for offsite use via the gas grid rather than for onsite electricity generation. Displacing natural gas with renewable gas for the City's proposed trigeneration network would make a significant contribution to reducing greenhouse gas emissions. It would also make the City of Sydney energy independent with an alternative source of renewable electricity, heating and cooling.

Thermal or biological conversion of waste and biomass would produce synthesis gas and/or biogas. These gases can be upgraded to substitute natural gas (SNG) in order to use the existing gas grid infrastructure.

The two main transportation methods considered as part of this Renewable Energy Master Plan is directly by pipeline to the nearest gas grid pipeline or indirectly by road freight to the nearest gas grid pipeline. Whether a fuel is transported by road freight or pipeline is primarily a function of proximity to infrastructure.

1.

2.

3.

4.

5.

6.

1 RENEWABLE ENERGY RESOURCES

2 RE-THINKING RENEWABLE ENERGY

3 RENEWABLE ENERGY FOR THE CITY OF SYDNEY

4 PERFORMANCE MEASURES

5 ENABLING THE MASTER PLAN

6 CASE STUDIES

FIGURE 22: SUBSTITUTE NATURAL GAS DELIVERY PATHWAYS (SOURCE: TALENT WITH ENERGY)

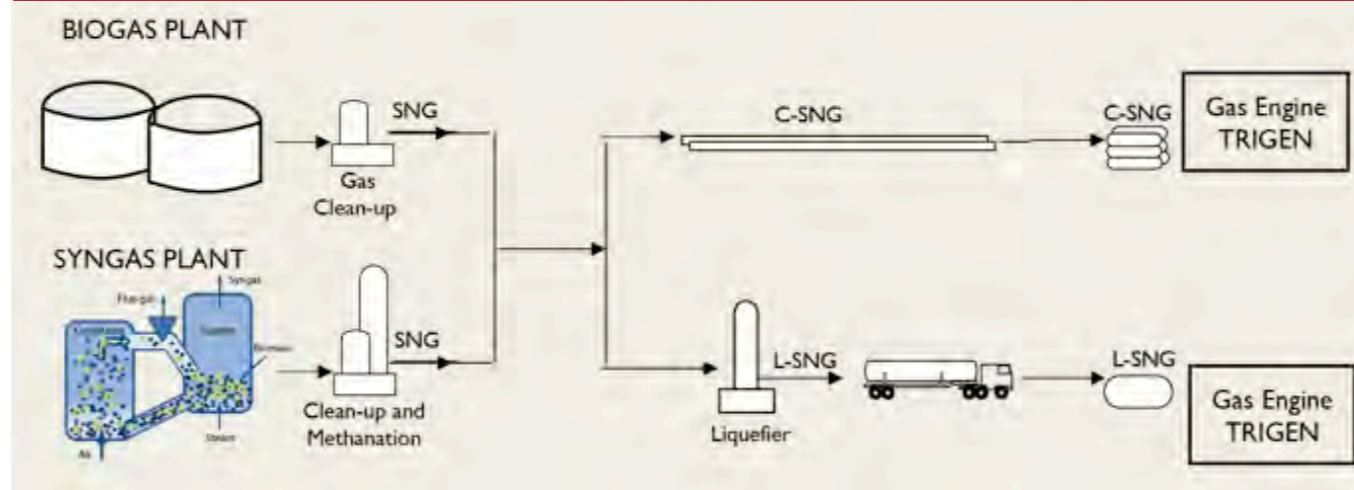

There are two principal technologies for producing renewable gas. One is based on thermal gasification and the other on anaerobic digestion. Each technology involves the production of raw gas that is subsequently upgraded to substitute natural gas or pipeline quality gas. These processes are similar to how conventional natural gas is delivered.

FIGURE 23: THERMAL GASIFICATION (SOURCE: US NATIONAL GRID)

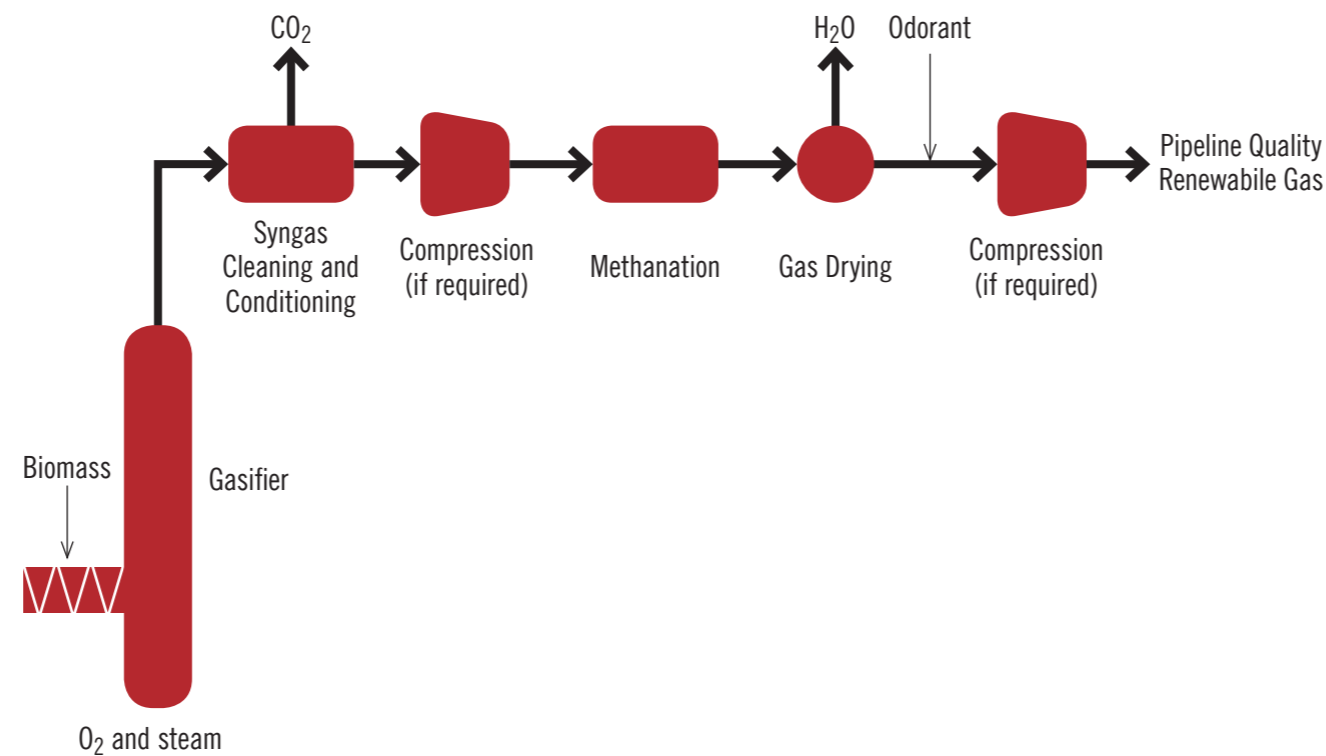

Thermal gasification such as advanced gasification/pyrolysis involves the production of a synthesis gas or syngas in a gasifier through the thermal breakdown of solid biomass into condensable gases. The raw syngas is mainly hydrogen (H₂), and carbon monoxide (CO). Syngas cleaning removes particulates, tars and other trace constituents. Renewable gas is produced by converting H₂ and CO into methane via a process known as 'methanation'. Thermal gasification is normally used for low moisture feedstocks such as woody biomass residues and crop residues. High moisture content feedstocks will also require drying before gasification.

- 1.
- 2.
- 3.
- 4.
- 5.
- 6.

In anaerobic digestion, micro-organisms, in the absence of oxygen, convert organic matter into biogas. Renewable gas is produced by drying the gas and removing trace elements. Anaerobic digestion is normally used for feedstocks with a moisture content of 70% or more such as food waste, animal manures and wastewater.

FIGURE 24: ANAEROBIC DIGESTION (SOURCE: US NATIONAL GRID)

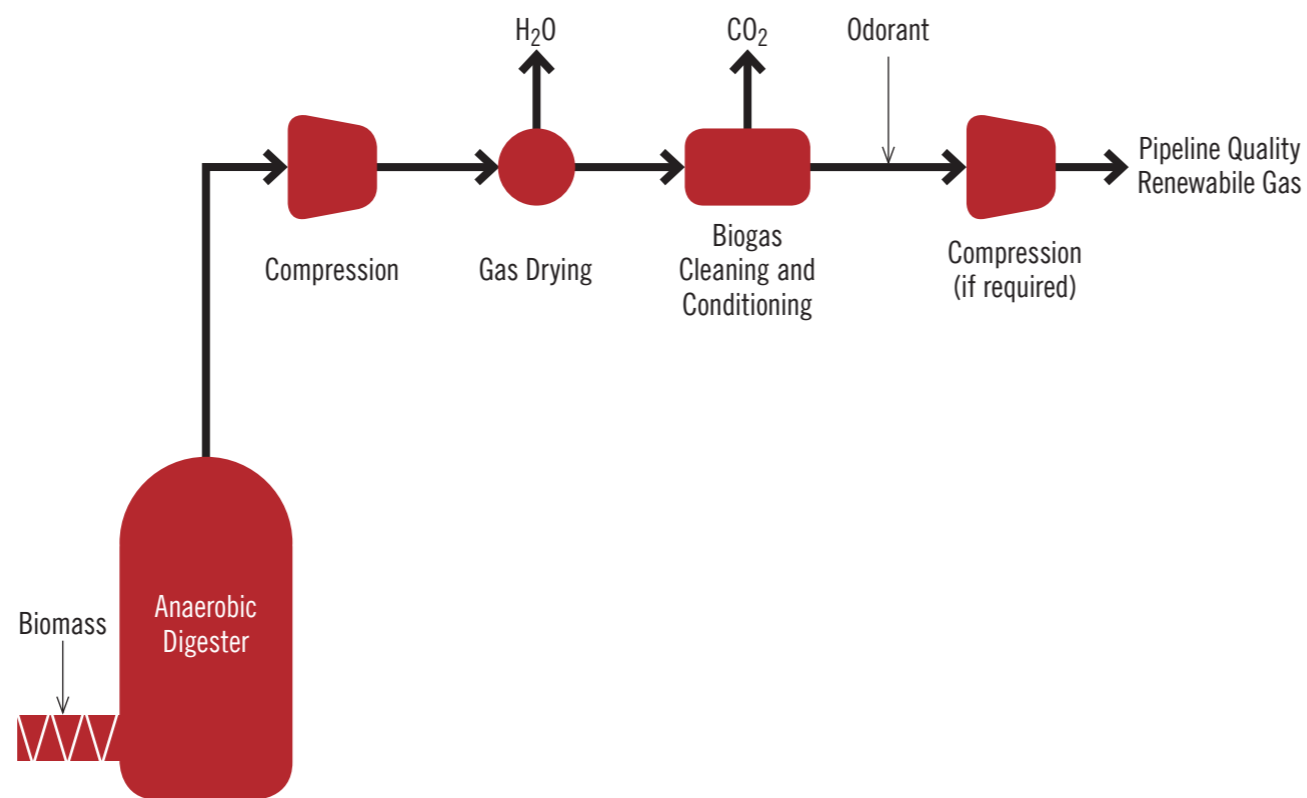

Landfill gas is also produced via an anaerobic process occurring over an extended period of time in the landfill as micro-organisms break down the organic fraction of waste. The raw landfill gas is collected via a network of perforated pipes and then processed in a similar way as biogas from anaerobic digestion.

Regardless of the process used to produce the raw gas, the conditioning step is a key element for creating renewable gas. Carbon dioxide (CO₂) and other trace elements are removed using numerous commercially available adsorption or separation systems. These processes can recover up to 98% of the methane from the gas and are the same processes used in conventional natural gas production processing.

Injecting renewable gas in the form of substitute natural gas into the existing natural gas grid pipeline for use in supplying the City's proposed trigeneration network is 250% more energy efficient than just generating electricity at remote locations where more than two thirds of the primary renewable energy would be rejected into the atmosphere in the form of waste heat similar to fossil fuel power stations.

**ANAEROBIC DIGESTION/
GASIFICATION FERTILISER AND
CARBON SEQUESTRATION**

Aerobic digestion or composting is the decomposition of organic matter in the presence of oxygen which produces a compost, carbon dioxide and low grade heat. Anaerobic digestion is the decomposition of organic matter in the absence of oxygen which produces

1 RENEWABLE ENERGY RESOURCES

2 RE-THINKING RENEWABLE ENERGY

3 RENEWABLE ENERGY FOR THE CITY OF SYDNEY

4 PERFORMANCE MEASURES

5 ENABLING THE MASTER PLAN

6 CASE STUDIES

a digestate and biogas. The biogas is used as a renewable gas, some of which can be used through a gas engine or boiler to heat the digestate to thermophilic temperatures to increase gas yields and to kill any pathogens in the digestate which can then be used as a clean fertiliser replacement or further composted to reduce the bulk. Gasification of organic waste produces a biochar which can also be used as a clean fertiliser replacement.

In addition to soil amelioration and crop productivity the by-products of renewable gas generation can also be used as carbon sinks. Buried in the ground or blended with topsoil, it may hold carbon for hundreds or thousands of years, locking away carbon dioxide rather than allowing it to escape into the atmosphere as methane where it would act as a greenhouse gas 21 times more powerful as a greenhouse gas than carbon dioxide over 100 years. Due to its negative carbon attributes by-products of renewable gas generation are eligible for carbon credits and is on the Carbon Farming Initiative positive list.

For the purposes of this Master Plan renewable gas is deemed to be carbon neutral since the release of carbon dioxide on combusting the gas is equal to the uptake of carbon dioxide from the atmosphere during the growth of the biomass or organics from which the renewable gas is derived. Where biomass or organic waste would otherwise be disposed of to landfill and produce methane renewable gas will have a negative carbon content equivalent to the Global Warming Potential (GWP) of the methane avoided, ie, -56 GWP over 20 years or -21 GWP over 100 years.

RENEWABLE GAS FEEDSTOCKS

Utilising renewable gases for the City's proposed trigeneration network would also overcome the intermittency of renewable energy as renewable fuelled trigeneration can provide base load, peak lopping and back up behaving in a similar way as fossil fuelled generation which it will replace.

The thermal conversion of waste and biomass to renewable gases, gas upgrade and transportation method may change with the introduction of alternative or non-organic waste to repeatable gases over time.

Waste and biomass resources within and beyond the City of Sydney which could be converted into synthesis gas or biogas and upgraded to substitute natural gas include:

1. City of Sydney LGA waste
2. Sydney Metropolitan Area waste
3. Extended Regulatory Area waste
4. Forestry residues
5. Broad acre crop residues
6. Manure waste
7. Horticulture waste
8. Sewage sludge
9. Existing landfill gas
10. Other beneficial biomass and waste, such as oil Mallee crops and bushland fire hazard reduction combustible materials.

FIGURE 25: SUSTAINABLE GAS NETWORK (SOURCE: US NATIONAL GRID)

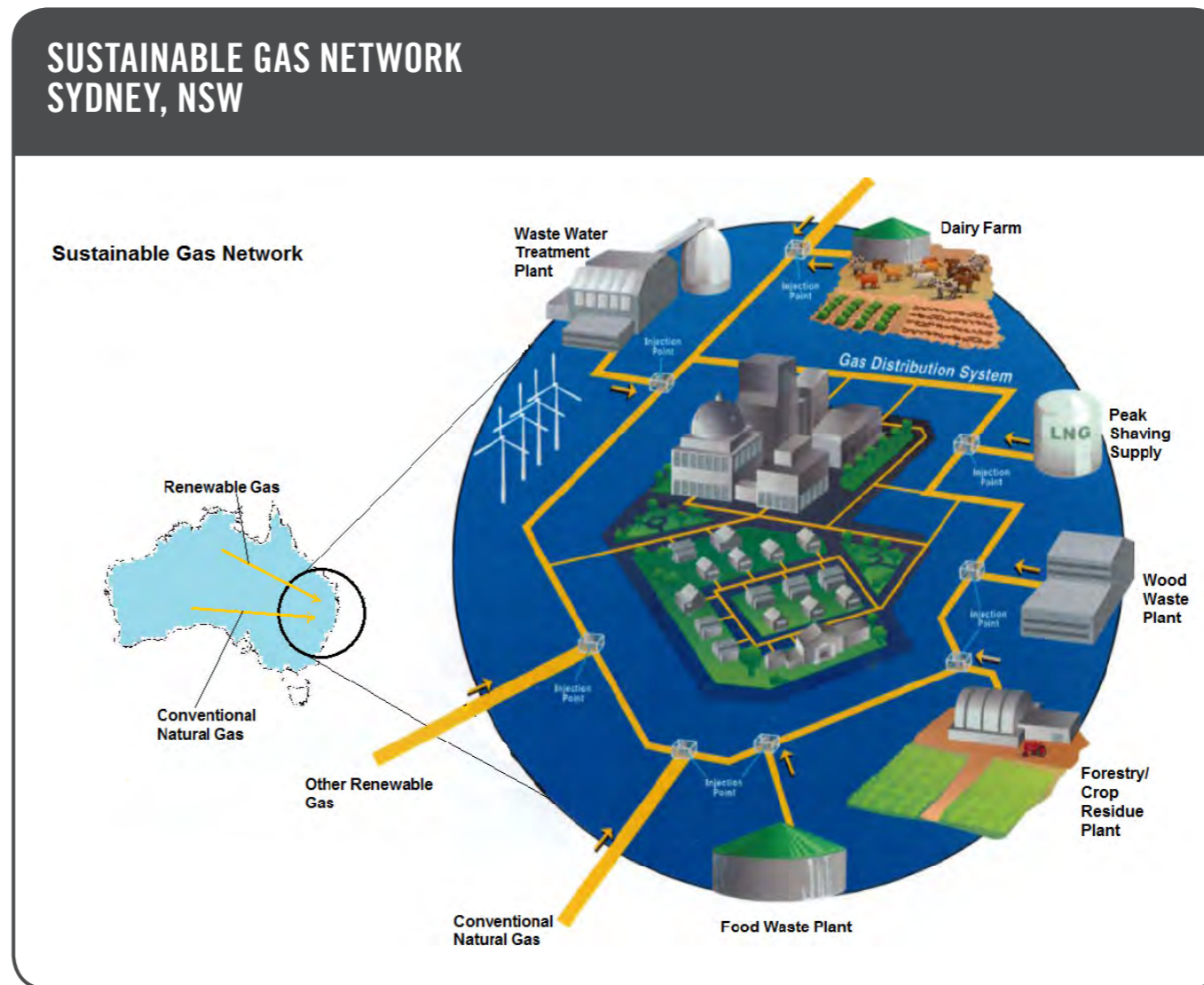

1.

2.

3.

4.

5.

6.

MUNICIPAL SOLID WASTE + COMMERCIAL AND INDUSTRIAL WASTES

The following maps show the waste zones considered within this Master Plan.

Municipal solid waste is domestic and commercial waste collected from households and businesses with the non recyclable component currently sent to landfill. The results shown also include commercial and industrial wastes.

FIGURE 26: WASTE REGULATED REGIONS (SOURCE: TALENT WITH ENERGY)

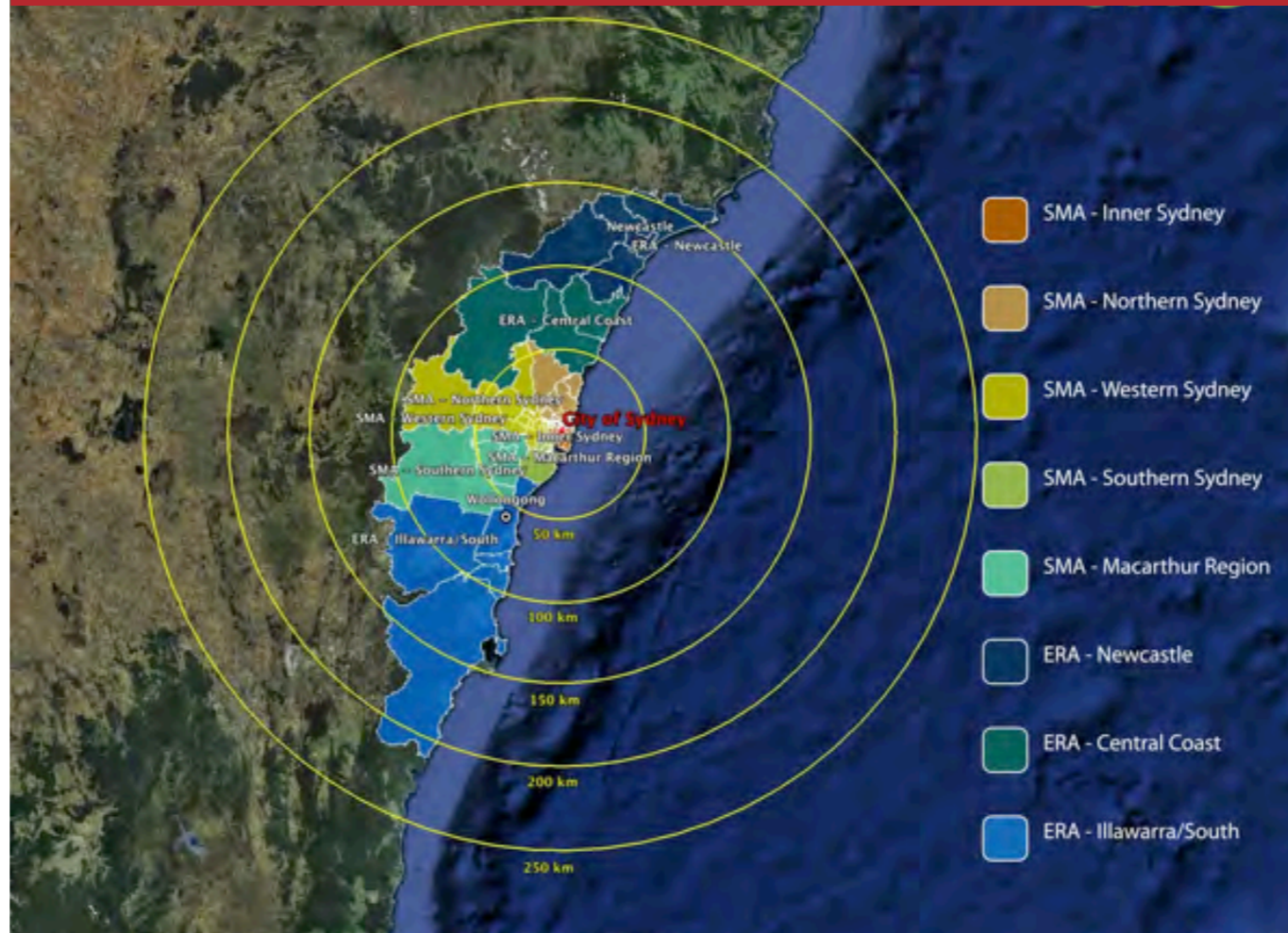

1 RENEWABLE ENERGY RESOURCES

2 RE-THINKING RENEWABLE ENERGY

3 RENEWABLE ENERGY FOR THE CITY OF SYDNEY

4 PERFORMANCE MEASURES

5 ENABLING THE MASTER PLAN

6 CASE STUDIES

FIGURE 27: RENEWABLE GAS/SUBSTITUTE NATURAL GAS RESOURCE AVAILABILITY (PJ/YEAR) (SOURCE: TALENT WITH ENERGY)

Type of gas	Maximum Availability (PJ per year)
SNG – MSW + C&I	21.60
SNG – Biomass	3.03
SNG – Large Scale Biogas	7.43
SNG – Small Scale Biogas	2.98
SNG – Landfill Gas	2.01
Total	37.06

Note: 1 Petajoule (PJ) of renewable gas is equal to 1 billion Megajoules (MJ) of renewable gas.

FIGURE 28: MSW – SYNGAS YIELD, RENEWABLE FRACTION PJ/Y – HHV (SOURCE: TALENT WITH ENERGY)

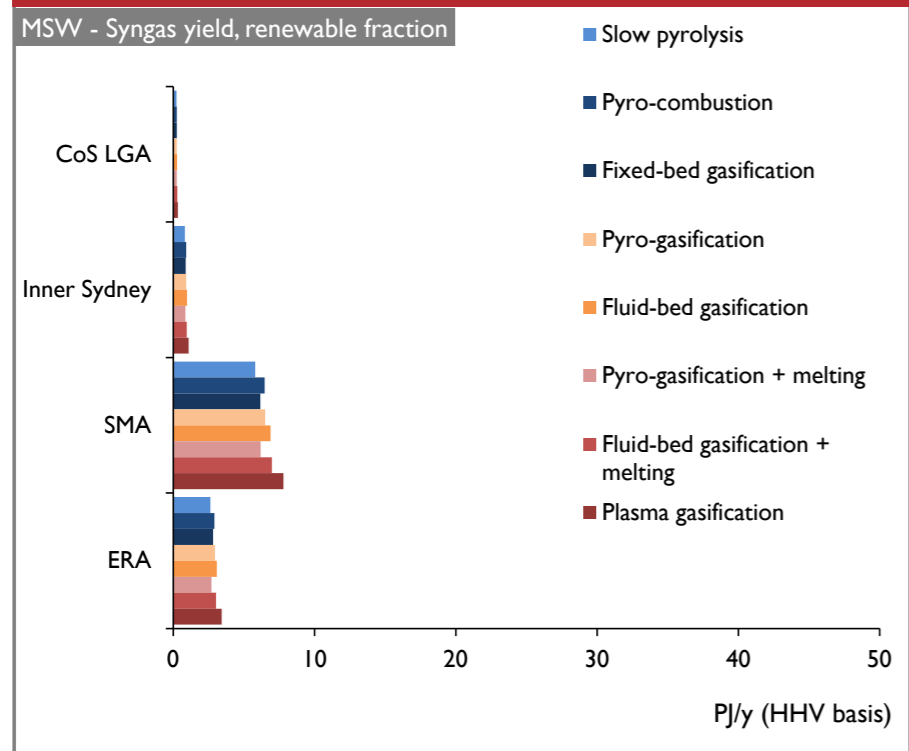
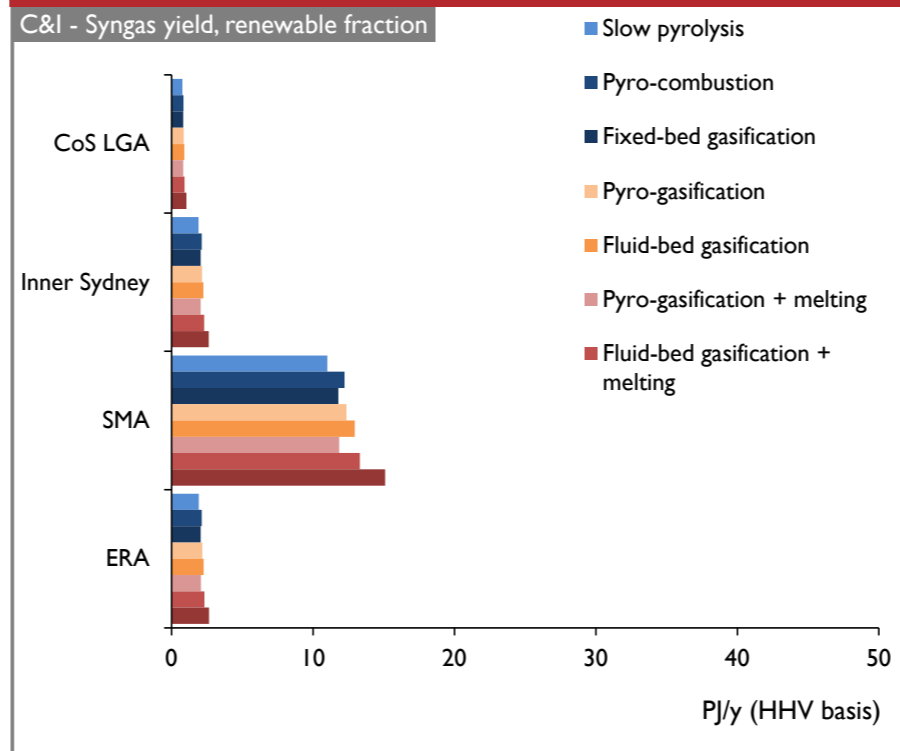

FIGURE 29: C&I – SYNGAS YIELD, RENEWABLE FRACTION PJ/Y – HHV (SOURCE: TALENT WITH ENERGY)



In addition to renewable gas availability shown in Figure 27, there is a further 11.9PJ/yr of non fossil fuel gas available from advanced gasification.

Renewable gas injected into the gas grid network is also referred to as biomethane (both biogas and syngas) in Europe and in some countries syngas is also referred to as biogas. Some countries also consider syngas from the inorganic fraction of waste as renewable gas. In this Master Plan renewable gases are defined as biogas derived from anaerobic digestion and syngas derived from the gasification of the organic fraction of waste. Non fossil fuel gas is defined as syngas derived from the gasification of the inorganic fraction of waste.

In some countries substitute natural gas is referred to as synthetic natural gas. In this Master Plan substitute natural gas (SNG) is defined as upgraded biogas and the 'methanation' of syngas, both to the same specification as pipeline quality natural gas, ie, green gas injected into the gas grid similar to renewable electricity or green power exported into the electricity grid.

- 1.
- 2.
- 3.
- 4.
- 5.
- 6.

FIGURE 30: FORESTRY AND BROADACRE CROP WASTE ENERGY RESOURCE
(SOURCE: TALENT WITH ENERGY)

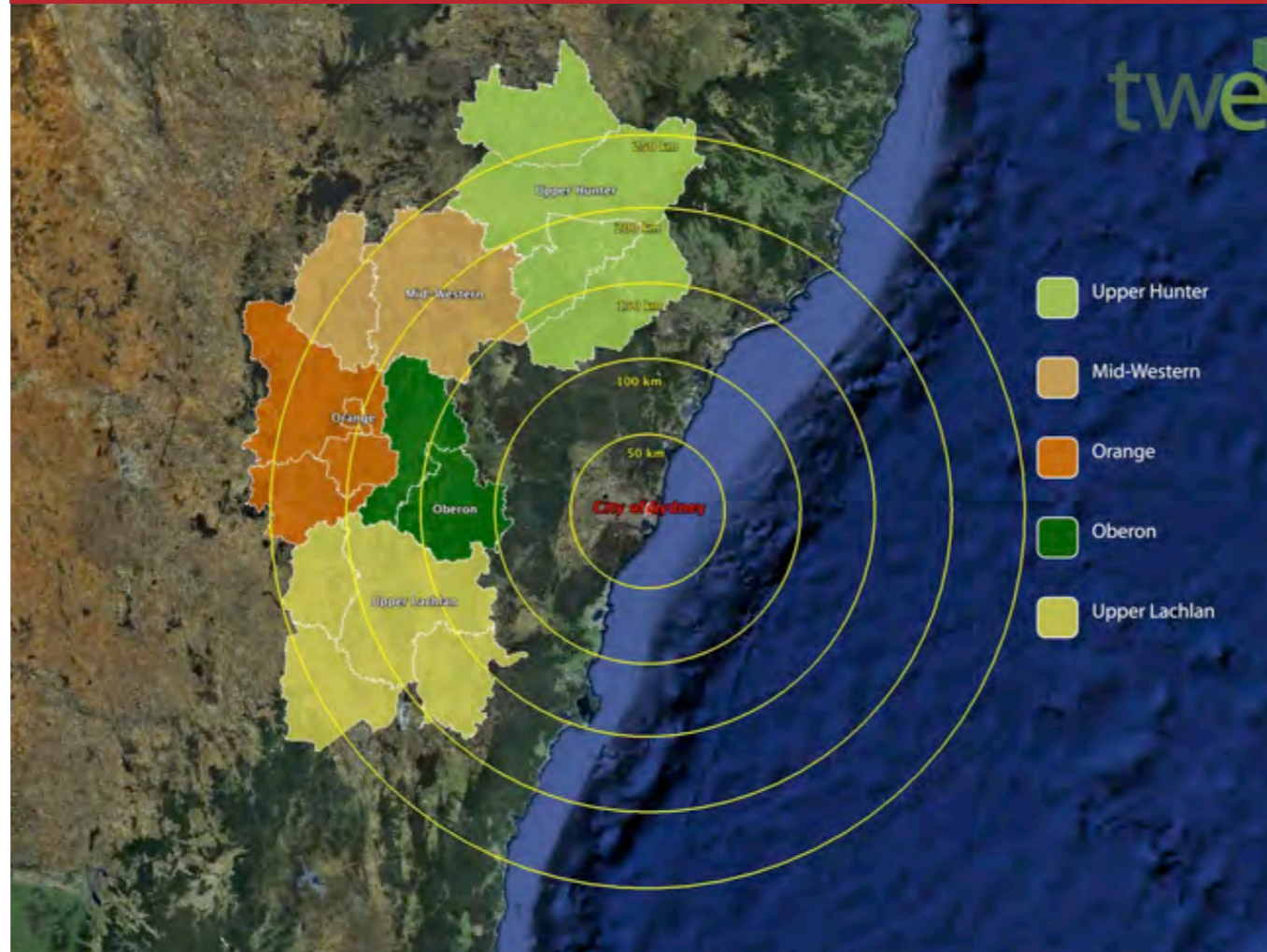

FORESTRY & BROADACRE CROP RESIDUES

There are significant quantities of agricultural and forestry waste currently being collected at a scale that would make gas conversion viable. This waste stream could be processed by a number of centralised renewable gas plants with conversion to liquid substitute natural gas by liquefaction for transportation by truck to an existing pipeline or the city.

Forestry residue is sourced from harvested timber plantations during processing. Large amounts of small branches, bark, and off-cuts are created as waste. Processing the harvested timber at saw-mills produces even more waste.

Another biomass feedstock opportunity could be the use of bushland fire hazard reduction materials, particularly where near to renewable gas collection or generation plants. Utilising these combustible materials for renewable gas production could significantly reduce the current fire hazard reduction burn-offs, with consequential air pollution and adverse health impacts, and the risk of accidental bushfires.

Broadacre crop waste is the stalks, husks and other waste generated from harvesting and processing crops, such as wheat, barley, oats, canola, lupins and hay. This feedstock could provide a significant renewable gas resource.

ANIMAL MANURES, HORTICULTURE WASTE AND SEWAGE SLUDGE

Horticulture waste exists on large farms in proximity to the city. Vegetable crop waste is organic waste sourced from harvesting vegetables and typically created during processing.

Animal manure produces carbon dioxide and methane as it decays. Cow, pig, and chicken manure is currently collected and treated through a number of methods which could produce a significant renewable gas resource.

Livestock manure is already collected and treated at many cattle feedlots, chicken farms and dairy farms, including using anaerobic digestion plants to produce biogas. This could be transported by pipeline for injection into the gas grid as a gaseous renewable gas or by truck to the gas grid as a liquefied renewable gas for re-gasification and injection into the gas grid.

Centralising anaerobic digestion/biogas for chicken manure and vegetable waste for upgrade to renewable gas could be sent to the city by an existing gas grid pipeline.

1 RENEWABLE ENERGY RESOURCES

2 RE-THINKING RENEWABLE ENERGY

3 RENEWABLE ENERGY FOR THE CITY OF SYDNEY

4 PERFORMANCE MEASURES

5 ENABLING THE MASTER PLAN

6 CASE STUDIES

FIGURE 31: LARGE-SCALE BIOGAS – FEEDSTOCK RESOURCE CATCHMENTS (SOURCE: TALENT WITH ENERGY)



FIGURE 32: SMALL-SCALE BIOGAS – FEEDSTOCK RESOURCE CATCHMENTS (SOURCE: TALENT WITH ENERGY)

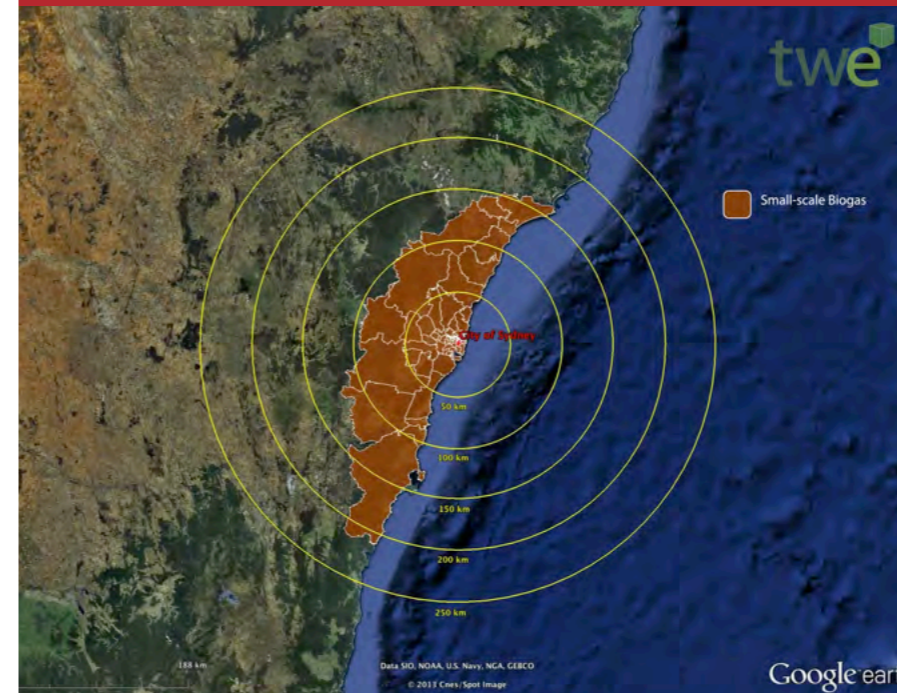

Anaerobic digestion can break down household and industrial sewage to produce carbon dioxide and methane and solid by-products used to make compost or liquid fertiliser.

Sewage could be converted to a renewable gas, upgraded to substitute natural gas, and transported by an existing gas grid pipeline to the city. Sewage gas is defined as small scale biogas in this Master Plan.

1.

2.

3.

4.

5.

6.

FIGURE 33: LANDFILL GAS (SOURCE: TALENT WITH ENERGY)



EXISTING LANDFILL GAS

There are many existing landfill gas generators in NSW. These fuels represent a small but important part of the renewable gas available to the City of Sydney.

SUBSTITUTE NATURAL GAS (SNG)
LEGEND:
 SfW-SNG – Syngas from Waste
 Sfb-SNG – Syngas from Biomass
 LsB-SNG – Large Scale Biogas
 SsB-SNG – Small Scale Biogas
 LFG-SNG – Landfill gas

FIGURE 34: SNG GENERATION TECHNICAL POTENTIAL TOTAL BY SOURCE (SOURCE: TALENT WITH ENERGY)

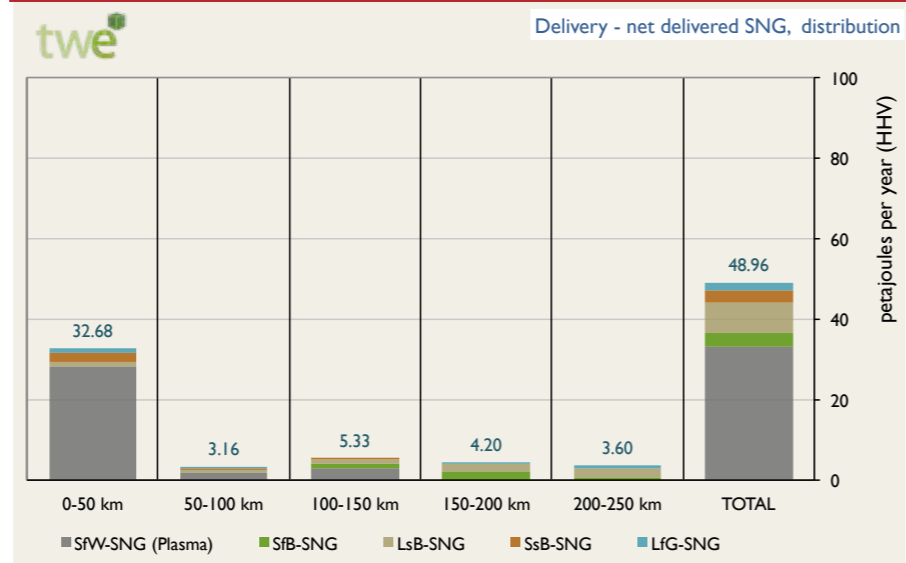
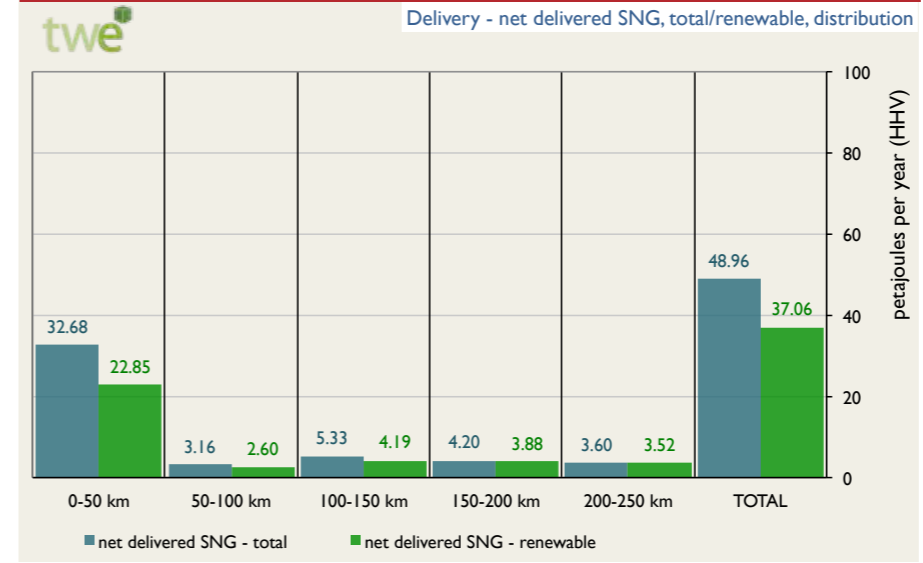

FIGURE 35: SNG GENERATION TECHNICAL POTENTIAL TOTAL (SOURCE: TALENT WITH ENERGY)



- 1 RENEWABLE ENERGY RESOURCES
- 2 RE-THINKING RENEWABLE ENERGY
- 3 RENEWABLE ENERGY FOR THE CITY OF SYDNEY
- 4 PERFORMANCE MEASURES
- 5 ENABLING THE MASTER PLAN
- 6 CASE STUDIES

- 1.
- 2.
- 3.
- 4.
- 5.
- 6.

FIGURE 36: MAIN GAS GRID NETWORK BEYOND CITY OF SYDNEY LGA (SOURCE: TALENT WITH ENERGY)

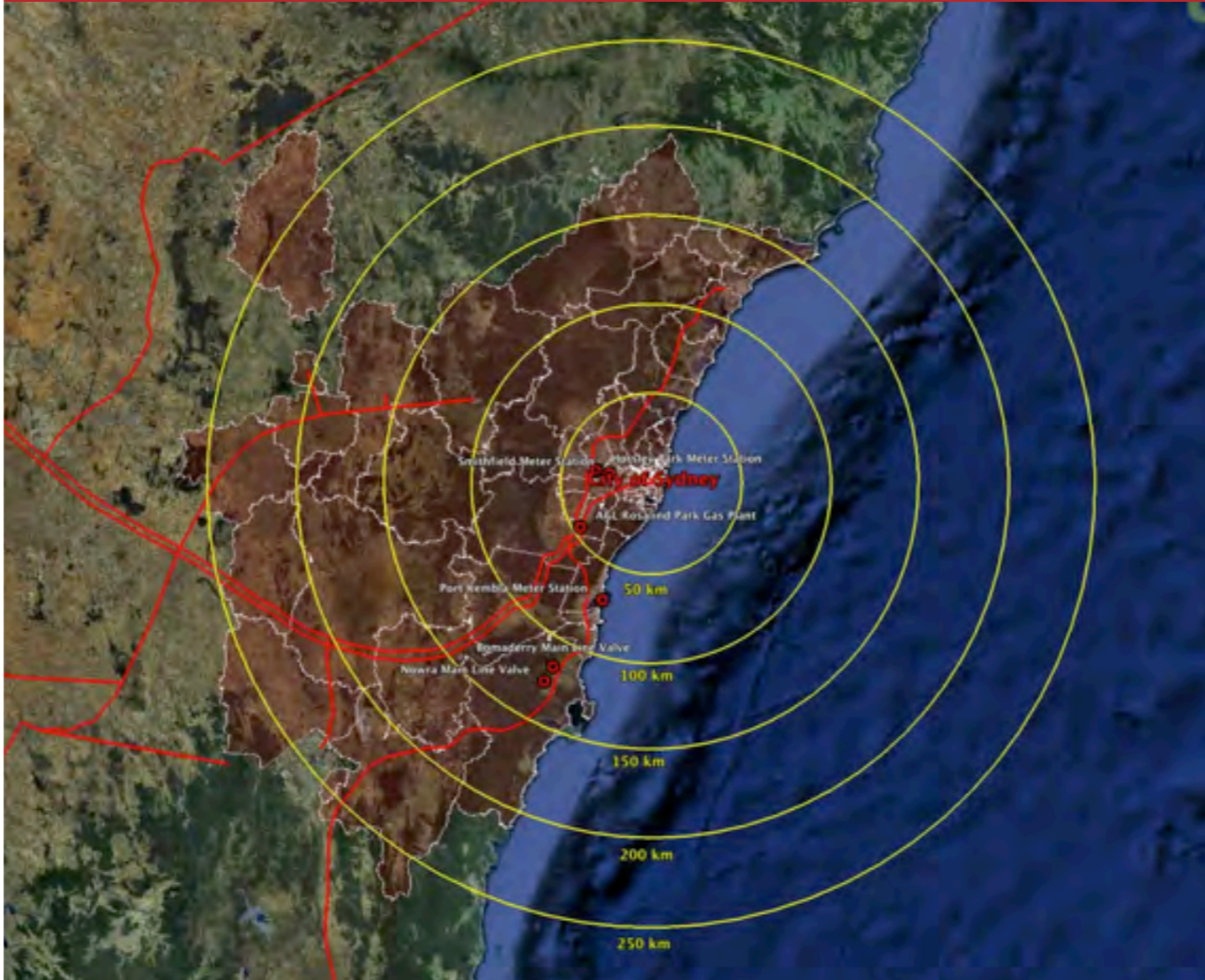

GAS GRID NETWORK

The proximity of the renewable gas resources derived from the various renewable feedstock locations were compared with the location of the existing main gas grid network to determine typical distances of renewable gas interconnecting pipelines or liquefaction transport distances, as applicable. Those renewable gas resources located nearest to the existing gas grid network are likely to be the first renewable gas resources developed.

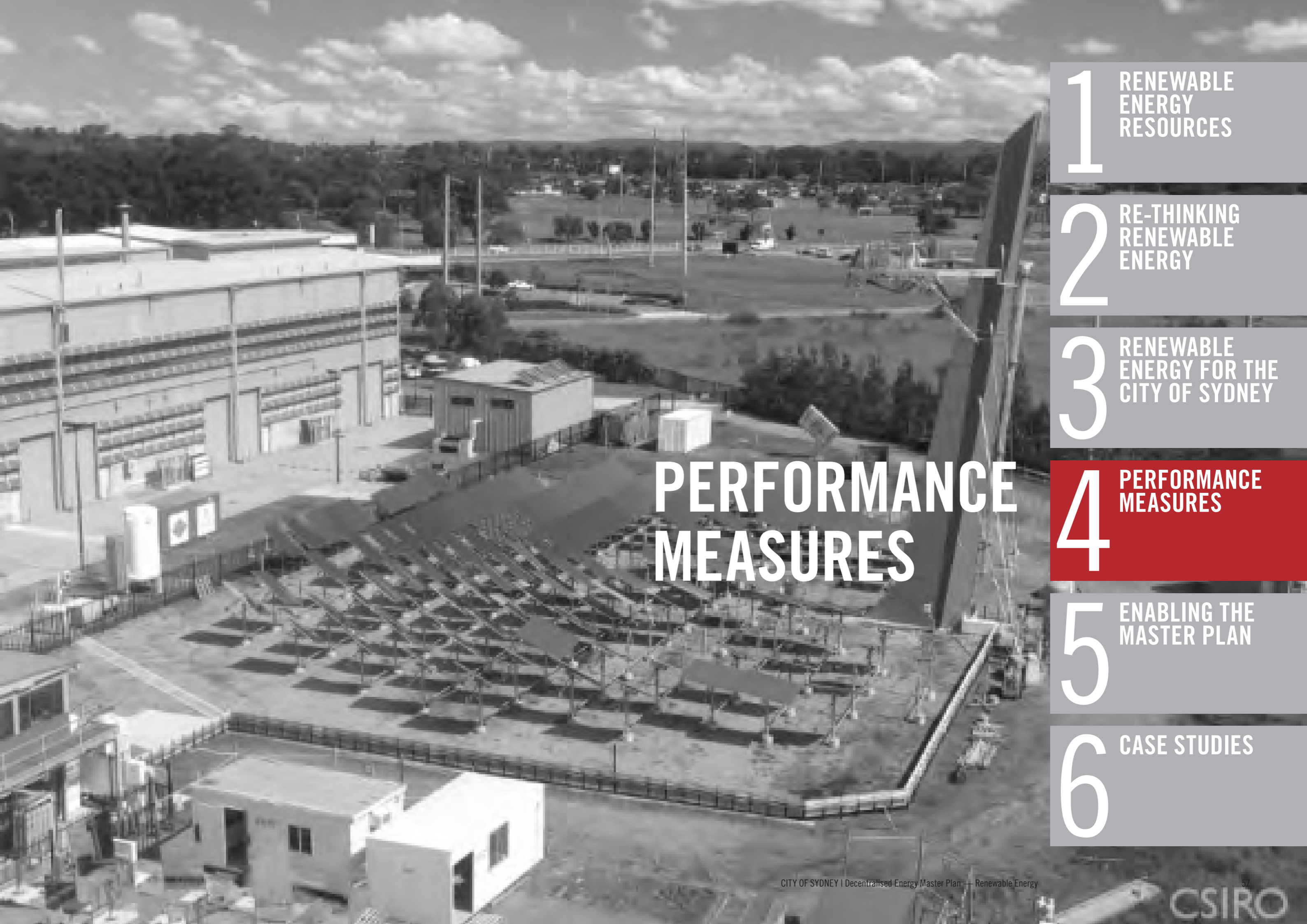

1 RENEWABLE ENERGY RESOURCES

2 RE-THINKING RENEWABLE ENERGY

3 RENEWABLE ENERGY FOR THE CITY OF SYDNEY

PERFORMANCE MEASURES

4 PERFORMANCE MEASURES

5 ENABLING THE MASTER PLAN

6 CASE STUDIES

PERFORMANCE MEASURES

SUMMARY OF KEY TECHNOLOGIES

These tables present the key results for each technology or feedstock that have been analysed in this Master Plan.

FIGURE 37: RENEWABLE ELECTRICITY	Installed capacity (MW)	Annual electricity generation or offset (GWh)	Percentage of 2030 total electricity demand (%)	Annual carbon abatement per year in 2030 (ktCO _{2-e})	Greenhouse gas emissions savings against 2030 BAU (%)
BUILDING SCALE RENEWABLE ELECTRICITY & HEAT WITHIN THE CITY OF SYDNEY LGA					
Solar thermal hot water	62.0	138	3.5	146	2.3
Solar photovoltaic (PV) panels	395.0	455	11.6	482	7.6
Micro wind turbines	0.5	1	0.1	1	0.02
SUBTOTAL	457.5	594	15.2	629	9.92
PRECINCT SCALE RENEWABLE ELECTRICITY WITHIN THE CITY OF SYDNEY LGA					
Concentrated solar thermal	21.0	47.0	1.2	50	0.8
Precinct scale wind turbines	51.0	51.0	1.3	54	0.8
Direct use geothermal – circulating hot water	5.0	11.0	0.3	12	0.2
SUBTOTAL	77.0	109.0	2.8	116	1.8
TOTAL FOR INSIDE CITY OF SYDNEY LGA	534.5	703	18.0	745	11.72
UTILITY SCALE RENEWABLE ELECTRICITY BEYOND THE CITY OF SYDNEY LGA					
Onshore Wind	170	468	12.0	412	6.48
Offshore Wind	140	468	12.0	412	6.48
Geothermal electricity	85	468	12.0	412	6.48
Concentrated solar PV	165	468	12.0	412	6.48
Concentrated solar thermal	230	468	12.0	412	6.48
Wave	210	468	12.0	412	6.48
Tidal	95	468	12.0	412	6.48
Hydro	85	468	12.0	412	6.48
TOTAL FOR BEYOND CITY OF SYDNEY LGA	170	468	12.0	412	6.48
TOTAL	704.5	1,171	30.0	1,157	18.2

Note 1: Utility Scale Renewable Electricity Beyond the City of Sydney LGA can be delivered by any one or a combination of the utility scale renewable electricity technologies listed to deliver the 30% renewable electricity target. For the purposes of this Master Plan this is based on Onshore Wind.

Note 2: Emission reductions for Building Scale Renewable Electricity & Heat Within the City of Sydney LGA and Precinct Scale Renewable Electricity & Heat Within the City of Sydney LGA are based on 1.06kg CO_{2-e}/kWh (Full Fuel Cycle Scopes 2 and 3) for New South Wales in Australian National Greenhouse Accounts – July 2013.

Note 3: Emission reduction for Utility Scale Renewable Electricity Beyond the City of Sydney LGA is based on 0.87kg CO_{2-e}/kWh (Full Fuel Cycle less Transmission and Distribution Losses Scope 2) for New South Wales in Australian National Greenhouse Accounts – July 2013.

Note 4: This Master Plan identifies resource potential for 51 megawatts of utility-scale wind turbines within the LGA, however the City has no plans to develop utility-scale wind turbines in the LGA. No sites have been identified or will be investigated, nor is private sector interest expected in the foreseeable future due to a combination of commercial, planning and community factors.

SUBSTITUTE NATURAL GAS (SNG)

LEGEND:

SfW-SNG – Syngas from Waste

SfB-SNG – Syngas from Biomass

LsB-SNG – Large Scale Biogas

SsB-SNG – Small Scale Biogas

LFG-SNG – Landfill gas

FIGURE 38: SUBSTITUTE NATURAL GAS DELIVERED (SOURCE: TALENT WITH ENERGY)

Pathway	SNG delivered, net PJ _{HHV} /y					TOTAL
	0-50 km	50-100 km	100-150 km	150-200 km	200-250 km	
net delivered SNG, total	32.68	3.16	5.33	4.20	3.60	48.96
with SfW-SNG (PG + Melting)	28.14	2.90	4.84	4.20	3.60	43.67
with SfW-SNG (FBG + Melting)	31.75	3.11	5.23	4.20	3.60	47.89
with SfW-SNG (Plasma)	32.68	3.16	5.33	4.20	3.60	48.96
SfW-SNG (Plasma)	28.31	1.65	3.05			33.01
wth SfW-SNG (PG + Melting)	23.77	1.39	2.57			27.72
wth SfW-SNG (FBG + Melting)	27.38	1.60	2.96			31.94
wth SfW-SNG (Plasma)	28.31	1.65	3.05			33.01
SfB-SNG			0.93	2.09	0.50	3.52
LsB-SNG	1.13	0.84	1.17	2.02	2.27	7.43
SsB-SNG	2.23	0.58	0.18			2.98
LFG-SNG	1.01	0.09		0.08	0.83	2.01
net delivered SNG, renewable	22.85	2.60	4.19	3.88	3.52	37.06
with SfW-SNG (PG + Melting)	18.93	2.38	3.77	3.88	3.52	32.48
with SfW-SNG (FBG + Melting)	20.81	2.55	4.09	3.88	3.52	34.85
with SfW-SNG (Plasma)	22.85	2.60	4.19	3.88	3.52	37.06
Syngas from Waste	18.48	1.09	2.02			21.60
wth SfW-SNG (PG + Melting)	14.56	0.86	1.60			17.02
wth SfW-SNG (FBG + Melting)	16.45	1.03	1.91			19.39
wth SfW-SNG (Plasma)	18.48	1.09	2.02			21.60
SfB-SNG			0.82	1.78	0.43	3.03
LsB-SNG	1.13	0.84	1.17	2.02	2.27	7.43

FIGURE 39: RENEWABLE GASES – CONVERSION, UPGRADING AND DELIVERY (SOURCE: TALENT WITH ENERGY)

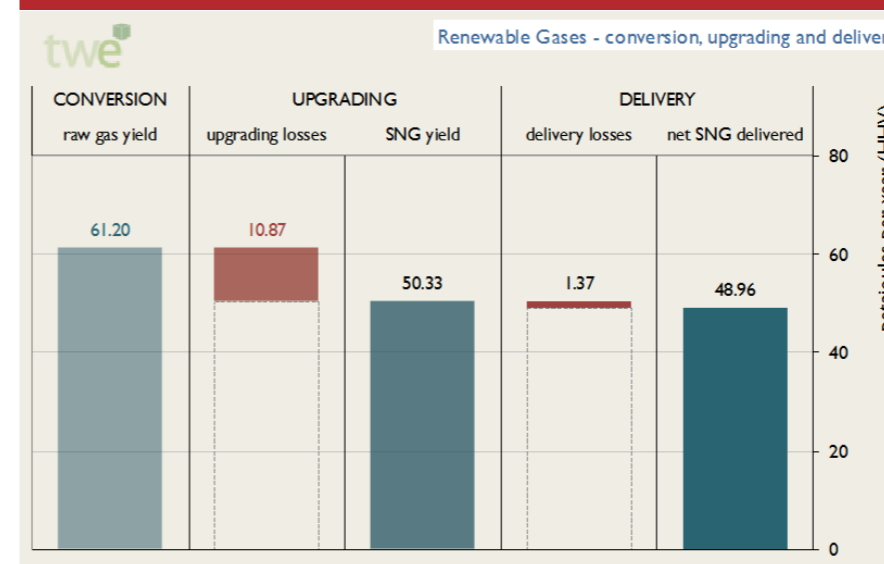

1 RENEWABLE ENERGY RESOURCES

2 RE-THINKING RENEWABLE ENERGY

3 RENEWABLE ENERGY FOR THE CITY OF SYDNEY

4 PERFORMANCE MEASURES

5 ENABLING THE MASTER PLAN

6 CASE STUDIES

1.

2.

3.

4.

5.

6.

Measuring the performance of the Renewable Energy Master Plan is based on evaluation of the capacity of renewable energy to meet the targets, and the additional cost in reducing carbon emissions.

TRACKING TOWARD OUR 2030 TARGETS

The renewable energy capacities and outputs in this chapter are based on the resource potentials identified in the previous chapter using currently available technologies. By 2030, the actual type and amount of renewable energy installed may be subject to change due to improved technical and/or commercial performance of existing and new technologies, price movements, government policies, development opportunities, planning conditions and other considerations.

This Master Plan shows that the City can meet its carbon reduction and renewable electricity and renewable gas targets using technologies that are commercially available today or will become commercially viable by 2030.

RENEWABLE ENERGY TARGETS

The target in Sustainable Sydney 2030 for the city to have the capacity to meet 100% of electricity demand by local electricity generation is based on the City of Sydney LGA electricity demand in 2030, taking account of building energy efficiency retrofits, the reduction in electricity demand for electric air conditioning chillers displaced by trigeneration and other measures such as LED street lighting and improved standards in the Minimum Energy Performance Standards (MEPS). This equates to 4,564GWh/year with 70% to be met by trigeneration and 30% to be met by renewable electricity.

The Trigenation Master Plan would deliver 3,700GWh/year or 81% of the local electricity generation target and the Renewable Energy Master Plan will deliver 1,171GWh/year or 30% of the local electricity generation target and 48.96PJ/year of syngas and biogas of which 37.06PJ/year is renewable gas and 11.9PJ/year is non fossil fuel gas. The renewable gas component of waste gas is more than the 27PJ/year of renewable gas needed to replace 100% of the natural gas supplying 372MWe of trigeneration in the City

of Sydney's proposed four low carbon zones or even the 32.7PJ/year needed to supply 477MWe of trigeneration and cogeneration across the City of Sydney's LGA as set out in the Decentralised Energy Master Plan – Trigenation. This renewable gas resource will also supply the 34.7PJ/year, including the 2PJ/year of domestic gas used for domestic heating and cooking, needed to replace 100% of the fossil fuel natural gas in the City's LGA.

The renewable gas modelled for the Renewable Energy Master Plan does not capture all of the biogas available from agriculture and farming within the 250km proximity zone as only a portion of biogas was needed to supplement the renewable syngas from municipal solid waste and commercial and industrial waste to supply the City of Sydney's planned trigeneration network.

The surplus renewable energy generation will help balance out peak and time of day energy demand and intermittency with any surplus renewable electricity and possibly surplus renewable gas or thermal energy being exported outside the City of Sydney LGA to adjacent local government areas.

1 RENEWABLE ENERGY RESOURCES

2 RE-THINKING RENEWABLE ENERGY

3 RENEWABLE ENERGY FOR THE CITY OF SYDNEY

4 PERFORMANCE MEASURES

5 ENABLING THE MASTER PLAN

6 CASE STUDIES

The following diagrams summarise the potential relative contribution of each renewable energy technology, if implemented, to the 100% renewable energy target.

FIGURE 40: CITY OF SYDNEY LGA RENEWABLE ELECTRICITY CONTRIBUTION TO 30% TARGET FOR 2030 (SOURCE: CITY OF SYDNEY)

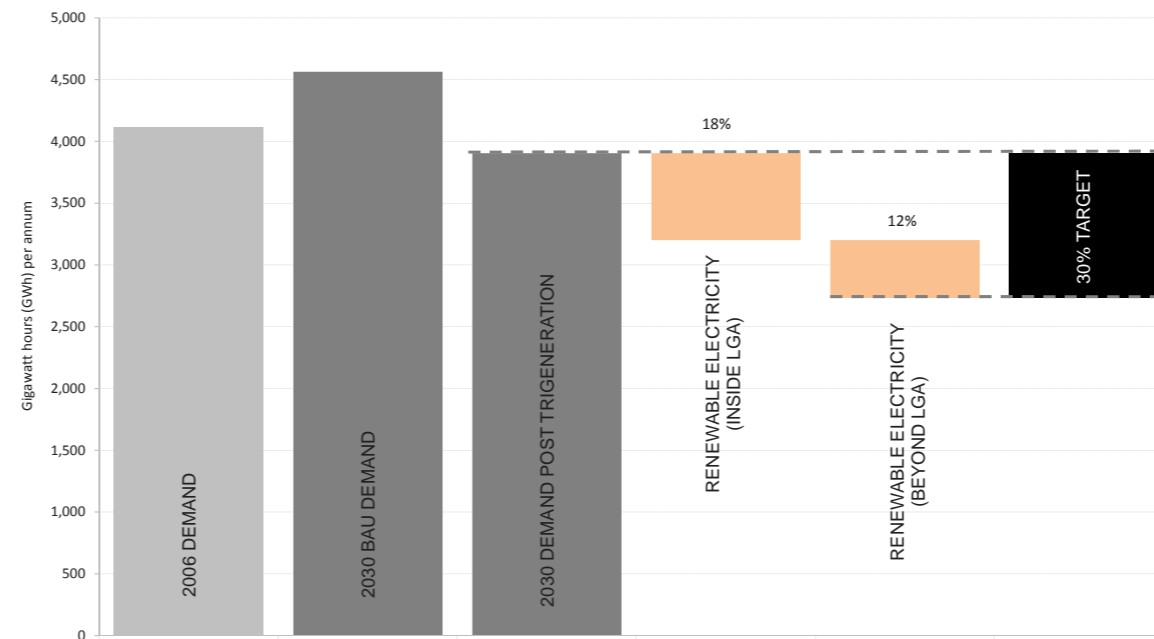
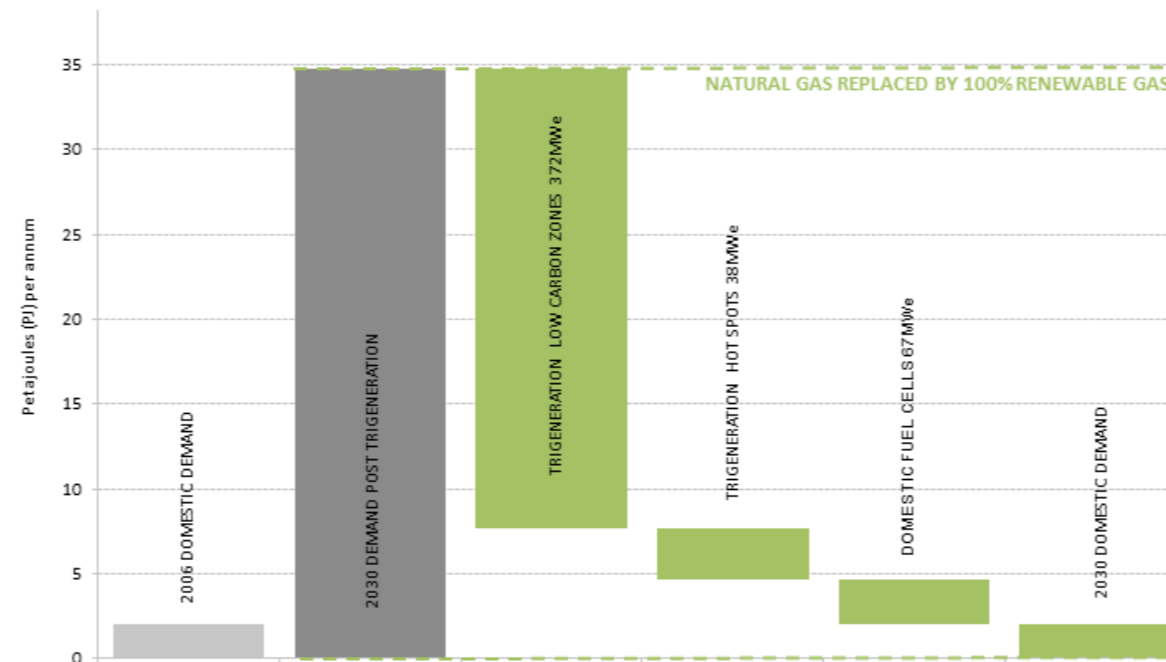

FIGURE 41: CITY OF SYDNEY LGA RENEWABLE GAS CONTRIBUTION TO 100% TARGET FOR 2030 (SOURCE: CITY OF SYDNEY)



1.

2.

3.

4.

5.

6.

CARBON EMISSIONS REDUCTION TARGET

The target in Sustainable Sydney 2030 to reduce greenhouse gas emissions by 70% by 2030 is based on 2006 levels. In 2006, emissions were 5.437 MtCO_{2-e}. Therefore, the city's emissions cannot exceed 1.631 MtCO_{2-e} per year by 2030.

Without action, annual greenhouse gas emissions are forecast to rise to 6.359 MtCO_{2-e} by 2030. Despite a small average decline in recent years, electricity and gas consumption within the City of Sydney will continue to grow into the future driven by new development, increased population and air conditioning loads. Therefore, the 2030 emission reduction target accounts for this additional growth.

This Renewable Energy Master Plan will reduce emissions by 2.384 MtCO_{2-e} per year by 2030 which equates to a 37.5% reduction against 2030 business as usual emissions.

Greenhouse gas emissions avoided include:

- 11.7% carbon saving from renewable electricity within the City of Sydney LGA
- 6.5% carbon saving from renewable electricity beyond the City of Sydney LGA
- 19.3% carbon saving from renewable gases from waste.

These overall greenhouse gas emission reductions for the City of Sydney LGA are in addition to the reduction in emissions of 2.027 MtCO_{2-e} per year by 2030 identified in the final Trigeneration Master Plan.

The combination of renewable electricity, renewable thermal energy, and trigeneration using renewable gas, would reduce greenhouse gas by a total of a 69.2%. These two master plans come close to achieving the overall target to reduce 2006 greenhouse gas emissions by 70% by 2030.

Renewable gases supplying the proposed trigeneration network in the city is key to achieving the carbon reduction target and delivering a constant non-intermittent renewable energy supply.

This Renewable Energy Master Plan forms one part of a range of other master plans included in the overall green infrastructure plan comprising trigeneration, renewable energy, advanced waste treatment, decentralised water and energy efficiency. In addition, other measures such as improving energy efficiency, reducing transport and street lighting emissions will also contribute towards delivering the 70% reduction in greenhouse gas emission target.

This Master Plan will contribute to the City's reduction in greenhouse gas emissions target as follows:

- Renewable energy technology installed on buildings and for precinct scale utilities within the City of Sydney LGA will reduce greenhouse emissions by 0.745 million tonnes of carbon dioxide equivalent (MtCO_{2-e}) per year by 2030.
- Renewable electricity beyond the City of Sydney LGA will reduce greenhouse gas emissions by 0.412MtCO_{2-e} per year by 2030.
- Renewable gas from waste will reduce greenhouse gas emissions by 1.227_{2-e} per year by 2030.

The following diagram summarises the potential relative contribution of each renewable energy technology, if implemented, to the greenhouse gas reduction target.

FIGURE 42: CITY OF SYDNEY LGA RENEWABLE ENERGY CONTRIBUTION TO 70% GREENHOUSE GAS EMISSION REDUCTION TARGETS FOR 2030 (SOURCE: CITY OF SYDNEY)

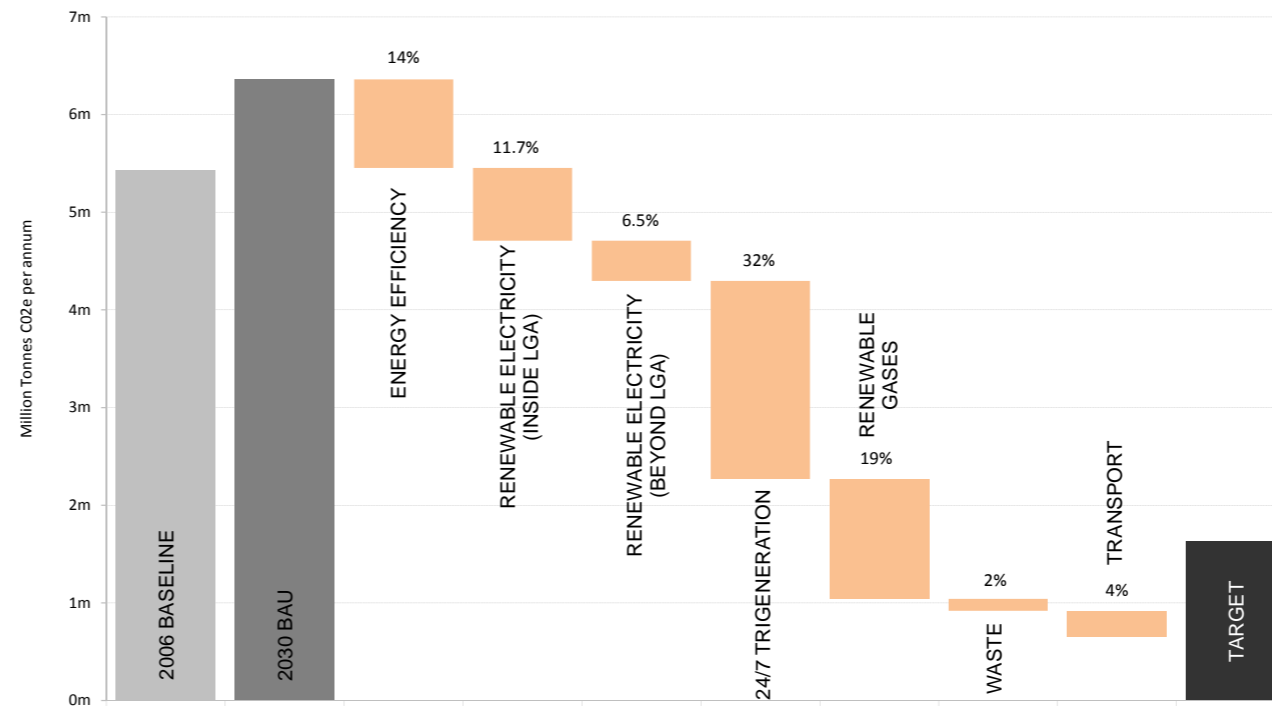

1 RENEWABLE ENERGY RESOURCES

2 RE-THINKING RENEWABLE ENERGY

3 RENEWABLE ENERGY FOR THE CITY OF SYDNEY

4 PERFORMANCE MEASURES

5 ENABLING THE MASTER PLAN

6 CASE STUDIES

1.

2.

3.

4.

5.

6.

MEETING THE 30% RENEWABLE ELECTRICITY TARGET

The City's 30% renewable electricity target will require 1,171 GWh per year of renewable electricity to replace the existing fossil fuels used in the electricity grid by 2030, taking account of growth. However, 1,350GWh of renewable electricity was originally modelled.

Renewable energy technologies could be feasibly installed on buildings in the city to generate or displace 594 GWh pa of grid electricity. A further 109 GWh pa can be generated from renewable power plants within the city.

This Renewable Energy Master Plan demonstrates that building and precinct scale renewable energy technologies located within the City of Sydney could potentially supply up to 18% of the city's total 2030 electricity consumption. In order to meet the City's 2030 target of 30% of electricity supplied by renewable energy, an additional 12% or 468 GWh will need to be supplied from outside the City of Sydney LGA.

Renewable gas from waste and biomass will achieve further greenhouse gas emission savings when used to supply the City's planned trigeneration network.

This Master Plan will contribute to the City's renewable electricity target as follows:

- Renewable electricity technologies installed on buildings and for precinct scale utilities within the city will contribute up to 18% of the city's electricity demand from renewable electricity generation or 703 gigawatt hours (GWh) of electricity each year.
- Renewable electricity technologies beyond the city will contribute at least 12% of the City's electricity demand from renewable electricity generation or 468 GWh of renewable electricity each year.

The renewable electricity generated by the City's planned renewable fuelled trigeneration network would be in addition to the above renewable electricity technologies.

The capital investment in renewable energy technologies on buildings is greater than for other technologies. However, installation of renewable energy technologies on buildings will generate up to the equivalent of 15.2% of the city's electricity demand.

Figure 43 shows the individual contribution of each renewable energy technology to achieve 30% of the city's electricity requirements from renewable energy by 2030. It shows that renewable electricity and heat technologies within the city will generate or replace up to 18% of the city's electricity demand by 2030.

FIGURE 43: 30% RENEWABLE ELECTRICITY TARGET BY TECHNOLOGY (SOURCE: CITY OF SYDNEY)

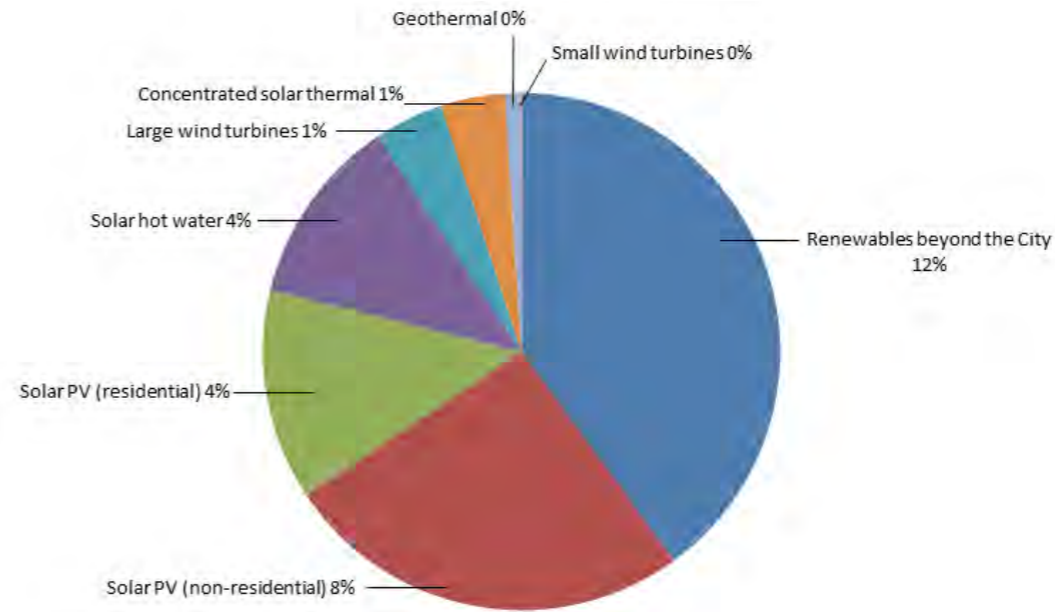

1 RENEWABLE ENERGY RESOURCES

2 RE-THINKING RENEWABLE ENERGY

3 RENEWABLE ENERGY FOR THE CITY OF SYDNEY

4 PERFORMANCE MEASURES

5 ENABLING THE MASTER PLAN

6 CASE STUDIES

Renewable electricity generated outside the city will make up the remaining capacity to achieve the City's renewable electricity target. In NSW, there are abundant resources available to establish cost competitive renewable energy power plants within 250 km proximity of the city by 2030. The renewable electricity technologies beyond the city assessed for this Master Plan will supply at least 468 GWh pa.

MEETING THE 100% RENEWABLE GAS TARGET

Utilising natural gas enables the economic construction of the City's proposed trigeneration network to supply low carbon electricity and zero carbon thermal energy for heating and cooling to the city's buildings. However, Council has resolved to replace natural gas with renewable gases derived from waste to supply the City's proposed trigeneration network by 2030. If the City of Sydney is successful in creating a market for renewable gases to supply the proposed trigeneration network, it could potentially achieve a 100% renewable fuelled trigeneration network by 2030.

To achieve this outcome, the majority of renewable gas will need to be sourced beyond the local government area.

Substitute natural gas, comprising renewable and non fossil fuel gas from waste can provide 48.96PJ/year, 178% of the 27PJ/year gas required to supply the proposed 372MWe of trigeneration in the City of Sydney's four low carbon zones, sourced within 250km of the City of Sydney LGA. Of this amount renewable gas can provide 37.06PJ/year, 145% of the gas required to supply the proposed 372MWe of trigeneration in the City of Sydney's four low carbon zones. Sufficient substitute natural gas and renewable gas resources can be sourced within 50km and just over 100km, respectively.

The renewable gas resource within 250km of the City's LGA can also supply the 32.7PJ/year needed to supply 477MWe of trigeneration and cogeneration across the City of Sydney's LGA or even the 34.7PJ/year needed to supply the 477MWe of trigeneration/ cogeneration and domestic gas used for heating and cooking in the City's LGA.

FIGURE 44: RENEWABLE GASES – SUPPLY REQUIREMENTS AND RESOURCE POTENTIAL 2029-30 (SOURCE: TALENT WITH ENERGY)

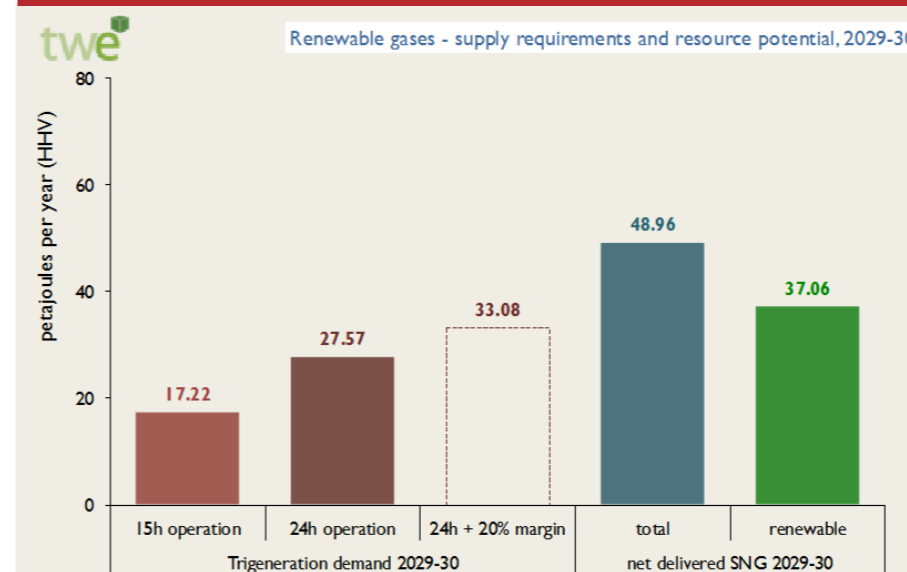

1.

2.

3.

4.

5.

6.

Other renewable fuels could also contribute towards the City's target to offset 100% of natural gas used for trigeneration by 2030, such as district solar water heating and direct use geothermal heat. Non fossil fuel gas from the inorganic fraction of waste could also be utilised.

The predominant waste streams within the city are residential and commercial waste and sewage streams. The main waste stream sourced from beyond the city will come from waste, livestock manure, forestry, horticulture and broad acre crop residues.

Renewable gases supplying the City's proposed trigeneration network would enable the City to exceed the 30% renewable energy target by more than 300% and make a much greater contribution to reducing greenhouse gas emissions.

FIGURE 45: TRIGENERATION NATURAL GAS DEMAND IN 2030 (SOURCE: KINESIS)

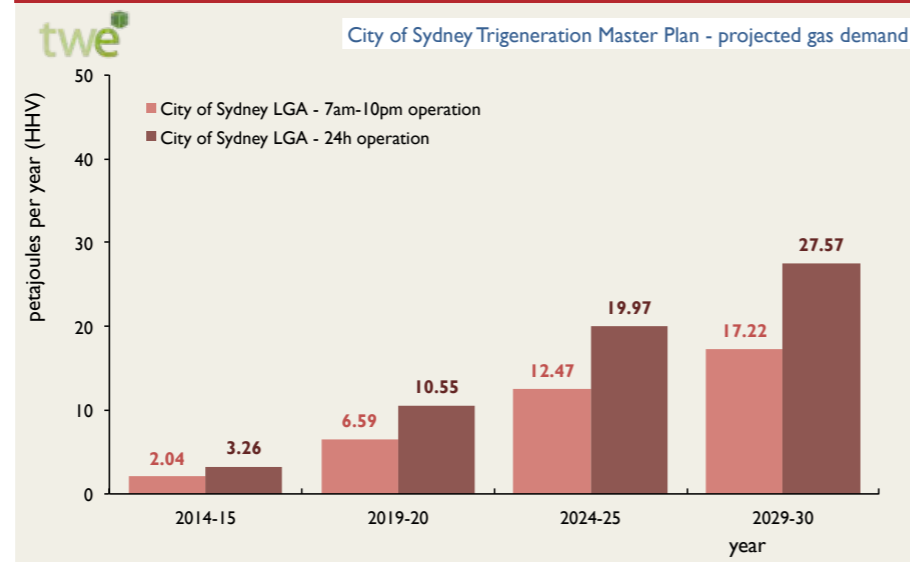
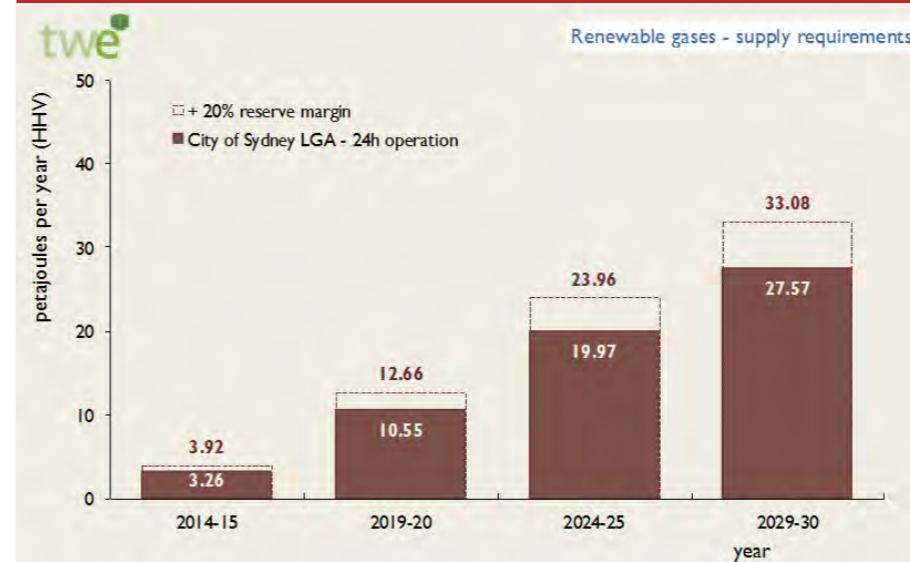

FIGURE 46: RENEWABLE GAS – SUPPLY REQUIREMENT (SOURCE: TALENT WITH ENERGY)



SUBSTITUTE NATURAL GAS (SNG)
LEGEND:
 SfW-SNG – Syngas from Waste
 Sfb-SNG – Syngas from Biomass
 LsB-SNG – Large Scale Biogas
 SsB-SNG – Small Scale Biogas
 LFG-SNG – Landfill gas

FIGURE 47: RENEWABLE GASES BY WASTE RESOURCES (SOURCE: CITY OF SYDNEY)

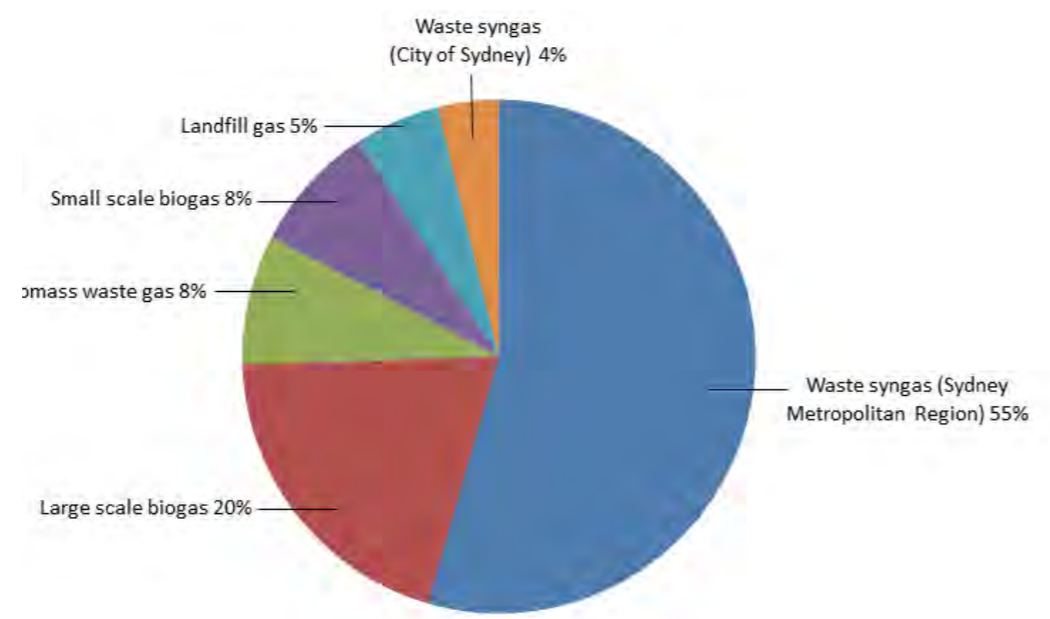
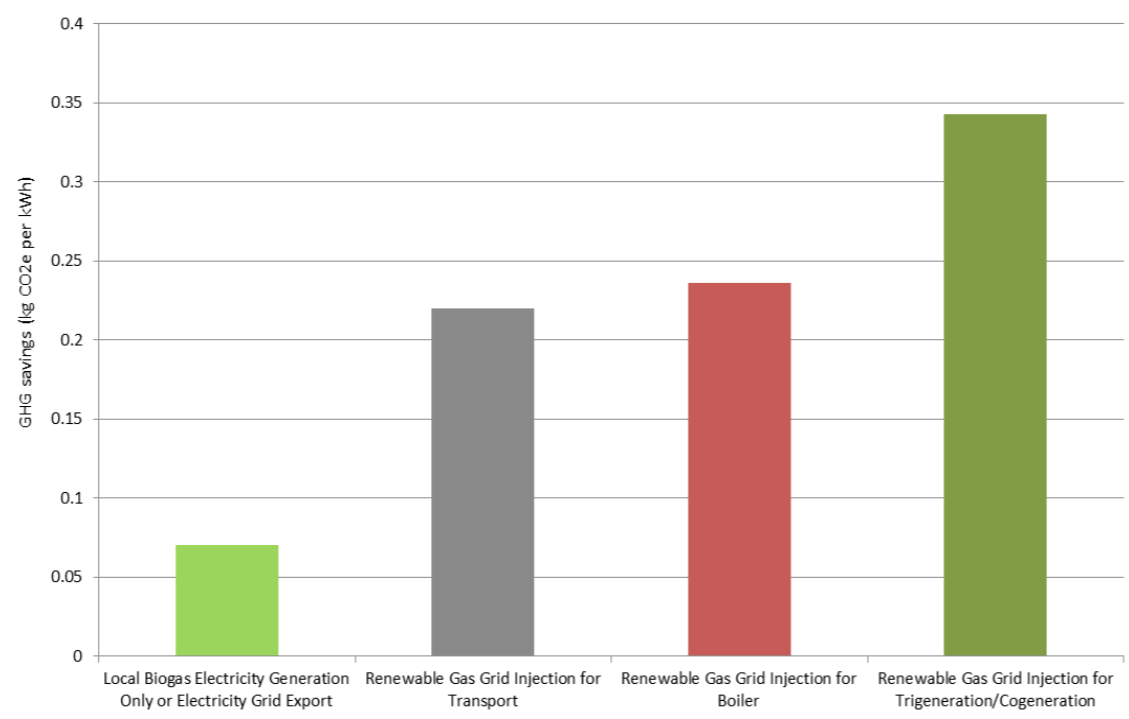

FIGURE 48: GREENHOUSE GAS EMISSION SAVINGS FOR RENEWABLE GAS GRID INJECTION (SOURCE: CITY OF SYDNEY)



RENEWABLE GAS V RENEWABLE ELECTRICITY EFFICIENCY
 Utilising renewable gas from bioenergy for injection into the gas grid recovers typically 80% of primary renewable energy resource at end use whereas generating electricity only from bioenergy recovers typically 20–35% of primary renewable energy resource for local or on site use, less 10% grid losses if exported into the grid for off-site end use. For renewable gas grid injection some of the gas is normally used for on site plant energy requirements, usually in the form of cogeneration, but the majority of renewable gas is grid injected. Therefore, renewable gas grid injection can deliver up to four times as much renewable energy at end use than electricity generation only.

1 RENEWABLE ENERGY RESOURCES

2 RE-THINKING RENEWABLE ENERGY

3 RENEWABLE ENERGY FOR THE CITY OF SYDNEY

4 PERFORMANCE MEASURES

5 ENABLING THE MASTER PLAN

6 CASE STUDIES

FINANCIAL AND ECONOMIC VIABILITY

1.

2.

3.

4.

5.

6.

While renewable energy technologies within the city may be more expensive than utility scale technologies beyond the city which can achieve economies of scale and more ideal resource conditions, it may become cost competitive where network charges can be avoided.

FINANCIAL ANALYSIS

The costs and achievement of the renewable energy and emission reduction targets are dependent on the uptake of the renewable energy technologies. Therefore, three scenarios were developed based around three different carbon price trajectories to 2030, as follows:

Central – Medium uptake scenario, based on ‘Government Policy’ scenario carbon price trajectory and electricity and gas price impacts. The City of Sydney’s renewable energy target is met by 2030.

High – based on a world where Australia faces a significantly higher carbon price as the result of more ambitious emission reduction targets, grid electricity and gas prices are higher than the central scenario, resulting in higher uptake of renewables. The City’s renewable energy target is exceeded by 2030.

Low – The low uptake scenario represents a world with slow carbon price growth, resulting in low electricity and gas prices and a relatively low rate of adoption of renewables. The City’s renewable energy target is only met by 2030 with higher subsidies.

The overall price of retail electricity is made up of generation, transmission, distribution, environmental and administrative charges, and retail costs.

In order to determine the cost of renewable energy the cost per unit of electricity generated over the lifetime of each renewable energy technology was calculated, referred to as the levelised cost of electricity (LCOE) or the levelised cost of gas (LCOG). The delivered costs, the amount of energy generation, and the volume of carbon abated were also analysed.

Renewable electricity generation beyond the city will also be subject to all the above costs. Renewable electricity generated beyond the city will also need to compete with the wholesale price of electricity in the National Electricity Market (NEM), taking account of the price on carbon or future emissions trading scheme.

Precinct renewable energy technologies connected to the City of Sydney LGA local distribution network are assumed to receive retail prices, less distribution use of system costs but with cost savings from avoided transmission use of system charges. For this scale of technology, the LCOE or LCOG must be comparable to

the retail cost, less distribution use of system costs plus the avoided network charges to be cost competitive.

Building scale renewable energy technologies are assumed to receive a cost saving by avoiding the retail costs of electricity plus any income from surplus electricity exported into the distribution network. For building scale technology, the LCOE or LCOG only needs to be comparable with the retail cost of electricity plus any surplus power export income as the owners are able to offset the entire retail cost by providing their own electricity.

This implies that while renewable energy technologies within the city may be more expensive than utility scale technologies beyond the city which can achieve economies of scale and more ideal resource conditions, it may become cost competitive where network charges can be avoided.

Due to the \$17.4 billion capital expenditure on electricity networks in NSW, retail electricity prices are expected to increase by 83% with network charges increasing to 60% of electricity bills over the 5 years to 2013/14. This is a trend of electricity price increases likely to continue to 2030 and beyond on a ‘business as usual’ basis. Therefore, the financial viability of renewable energy technologies within the city are likely to improve as electricity prices rise into the future.

The economics of technologies connected to the distribution network could be significantly improved if the electricity was able to be traded outside of the National Electricity Market on the ‘virtual private wire’ over public wires principle similar to the UK. This would require the removal of regulatory barriers to decentralised energy. This is included in the enabling actions outlined in the next chapter.

COST OF RENEWABLE ELECTRICITY

The estimated costs of constructing generating capacity using each type of renewable electricity technology and resources are detailed in Figure 49. Where available capital cost estimates are drawn from the Australian Energy Technology Assessments (AETA) published by the Australian Government. Estimates for the remaining technologies were produced by the Allen Consulting Group using other public domain information.

The cost of operating electricity generators fall under two categories: fixed and variable.

The delivered cost for each renewable energy technology is the combination of capital expenditures and the fixed and variable operating expenditures. The delivered cost represents the minimum price that electricity produced by each technology need to be sold at, inclusive of transmission and distribution costs in order to break even.

FIGURE 49: ESTIMATED DELIVERED COST BY RENEWABLE ENERGY TECHNOLOGY, REAL 2012 DOLLARS PER MEGAWATT HOUR OF GENERATION (\$/MWH) (SOURCE: ALLEN CONSULTING GROUP, BUREAU OF RESOURCES AND ENERGY ECONOMICS 2012, AND CSIRO 2011)

Technology / Resource	2012	2020	2025	2030
Building integrated within LGA				
Solar hot water	270	275	271	275
Solar PV	292	242	204	180
Micro wind	299	196	190	194
Precinct scale within LGA				
Wind turbines	335	264	276	291
Direct use geothermal	261	270	276	282
Concentrating solar thermal	440	327	314	319
Renewable electricity beyond the City				
Onshore wind	245	233	243	250
Offshore wind	323	321	333	337
Geothermal electric	338	356	366	371
Concentrating solar PV	358	298	299	296
Concentrating solar thermal	476	379	365	373
Wave	424	446	374	376
Tidal	455	478	407	412
Hydro	316	333	347	362
Baseline technology				
Black coal	191	215	235	253

1 RENEWABLE ENERGY RESOURCES

2 RE-THINKING RENEWABLE ENERGY

3 RENEWABLE ENERGY FOR THE CITY OF SYDNEY

4 PERFORMANCE MEASURES

5 ENABLING THE MASTER PLAN

6 CASE STUDIES

COST OF RENEWABLE GAS

The estimated costs of constructing generating capacity using each type of renewable gas technology and resources are detailed in Figure 50. Natural gas capital cost estimates are drawn from the Australian Energy Technology Assessments (AETA) published by the Australian Government and the four types of renewable gas/substitute natural gas (SNG) were estimated by Talent With Energy.

The four types of renewable SNG analysed are, as follows:

- SNG sourced from municipal solid waste (MSW) and commercial and Industrial (C&I) waste;
- SNG sourced from biomass, such as forestry waste and broadacre crop residue;
- SNG sourced from large scale biogas, such as vegetable crops and horticulture, chicken and cattle manure; and
- SNG sourced from small scale biogas (including sewage gas) and landfill gas.

With the exception of conventional natural gas, the costs of SNG are based on a levelised cost of gas (LCOG).

FIGURE 50: ESTIMATED DELIVERED COST OF NATURAL GAS AND RENEWABLE GAS, BY TYPE OF GAS, 2012 DOLLARS PER GIGAJoule (SOURCE: TALENT WITH ENERGY)

	SNG delivered, net PJ _{HHV} /y		Gas prices (Central), AUD ₂₀₁₂ /GJ _{HHV}			
	total	renewable	2014-15	2019-20	2024-25	2029-30
Natural gas (NSW,ACT) ^a			6.99	8.57	10.14	11.71
Substitute Natural Gas ^b	48.96	37.06				
SNG-SfW (plasma)	33.01	21.60	6.2 - 6.4	4.66 - 4.81	3.46 - 3.57	2.55 - 2.63
SNG-SfB ^c	3.52	3.03	10.69 - 13.85	7.44 - 9.63	5.18 - 6.68	3.6 - 4.62
SNG-LsB ^c	7.43	7.43	6.95 - 18.27	5.07 - 13.04	3.68 - 9.28	2.65 - 6.75
SNG-SsB	2.98	2.98	6.18	4.39	3.11	2.19
SNG-LfG	2.01	2.01	6.84	4.76	3.32	2.31

^a Projected natural gas prices from (BREE 2012), Table 2.3.2

^b Estimates from Talent with Energy (2012), include delivery operations (10 km injection pipeline for C-SNG delivery), pipeline T&D charges and 15% retail margin

^c Estimates from Talent with Energy (2012), high estimates for sites with L-SNG delivery

SUBSTITUTE NATURAL GAS (SNG)

LEGEND:

- SfW-SNG – Syngas from Waste
- SfB-SNG – Syngas from Biomass
- LsB-SNG – Large Scale Biogas
- SsB-SNG – Small Scale Biogas
- LfG-SNG – Landfill gas

1.

2.

3.

4.

5.

6.

1 RENEWABLE ENERGY RESOURCES

2 RE-THINKING RENEWABLE ENERGY

3 RENEWABLE ENERGY FOR THE CITY OF SYDNEY

4 PERFORMANCE MEASURES

5 ENABLING THE MASTER PLAN

6 CASE STUDIES

ECONOMIC ANALYSIS

The marginal social cost of abatement is defined as the marginal or incremental cost to society of the modelled scenario versus business as usual. This analysis involves like-for-like comparison of alternative technologies, based on a common set of assumptions and consistent costing methodology between the alternative technologies.

The cost of abatement approach enables renewable energy and other energy technologies to be valued according to the emissions content (or lack of emissions content) of its generated energy. Therefore, under the economic analysis approach, unlike in the financial analysis model, all of the renewable energy is assumed to be sold at a price that values its lack of emissions intensity, and grid energy is sold at its standard rate.

The City of Sydney commissioned the Allen Consulting Group and Talent With Energy to assess the renewable energy opportunities identified in this Master Plan together with the greenhouse gas abatement potential in order to quantify the marginal social cost of abatement against business as usual, ie, high carbon centralised energy generation. These results are presented right.

FIGURE 51: MARGINAL SOCIAL COST OF ABATEMENT: CENTRAL SCENARIO, 2020 (REAL 2012 DOLLARS PER TONNE OF CO₂ EQUIVALENT EMISSIONS ABATEMENT (SOURCE: ALLEN CONSULTING GROUP)

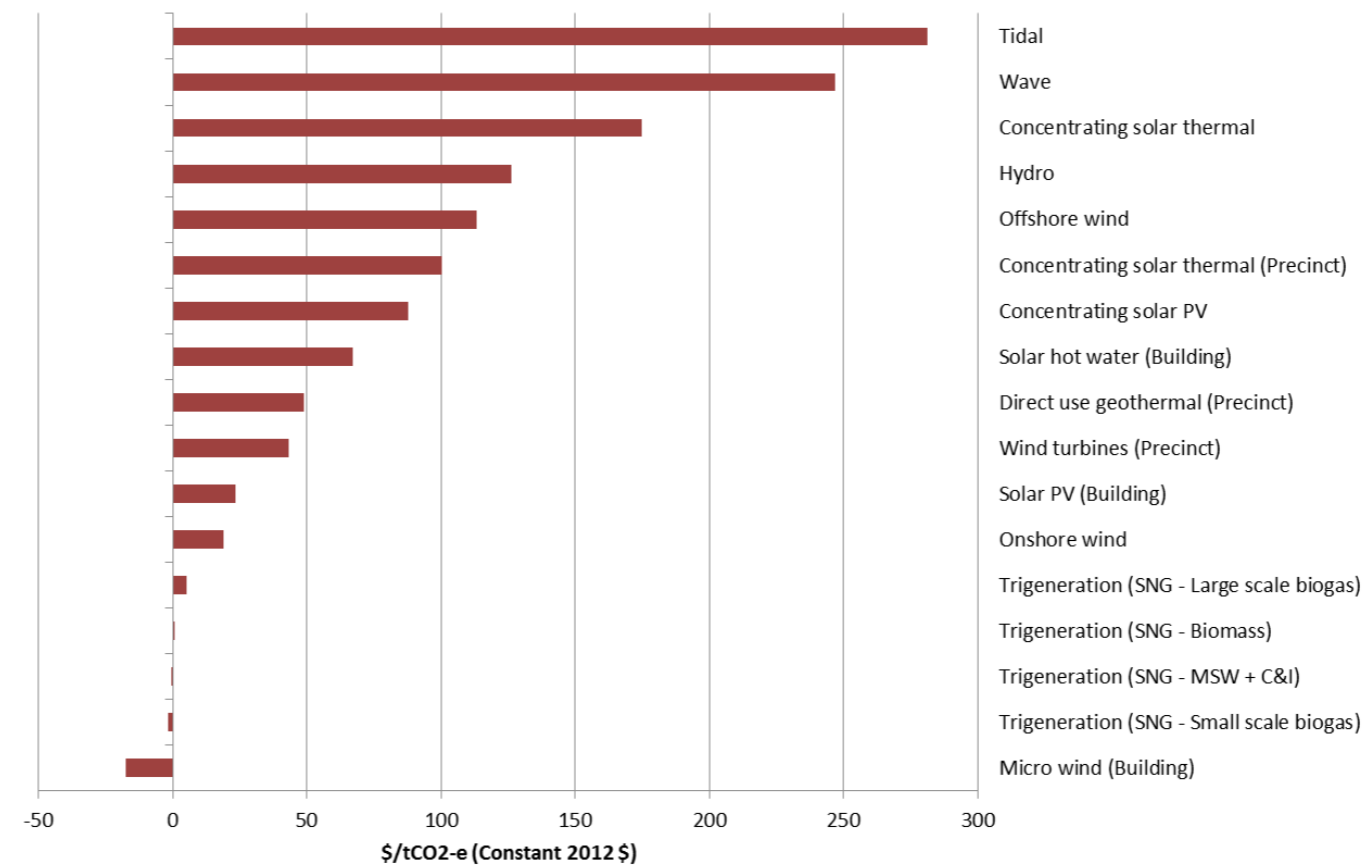

Micro wind and trigeneration supplied by renewable gases from waste could potentially have negative marginal social costs of abatement by 2020. However, micro wind is an intermittent renewable energy technology and can only provide a fraction of the City's electricity requirements (less than 1%).



FIGURE 52: MARGINAL SOCIAL COST OF ABATEMENT: CENTRAL SCENARIO, 2025 (REAL 2012 DOLLARS PER TONNE OF CO₂ EQUIVALENT EMISSIONS ABATEMENT (SOURCE: ALLEN CONSULTING GROUP)

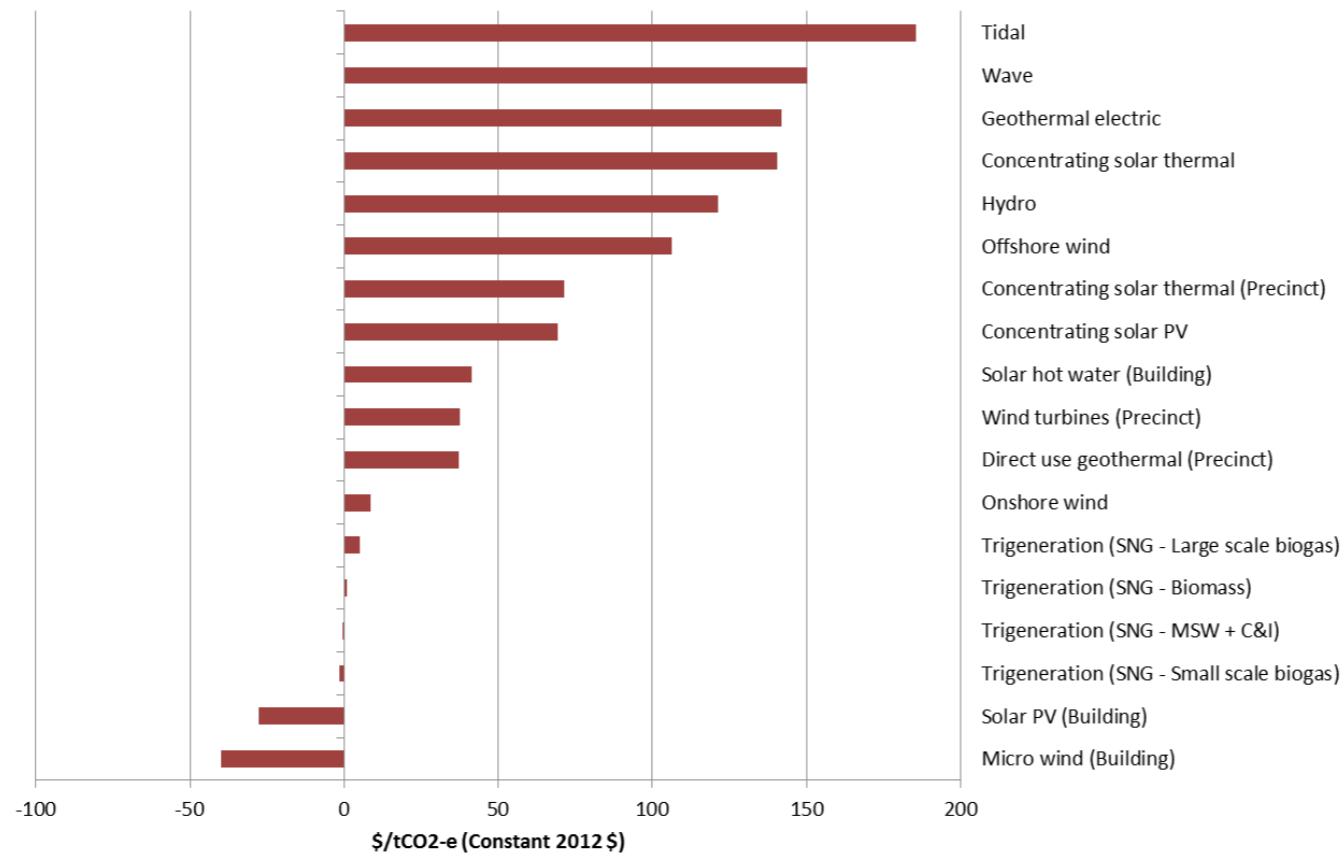

Precinct scale geothermal district heating and large scale onshore wind energy as low cost of carbon abatement technologies join micro wind and trigeneration supplied by renewable gases negative cost of abatement technologies by 2025. Solar PV will also be a negative cost of carbon abatement technology by 2025. However, solar PV and large scale onshore wind energy are both intermittent renewable energy technologies. Solar energy sourced from within the LGA can supply/displace 16.3% maximum of the City's LGA electricity requirements by 2030.

1 RENEWABLE ENERGY RESOURCES

2 RE-THINKING RENEWABLE ENERGY

3 RENEWABLE ENERGY FOR THE CITY OF SYDNEY

4 PERFORMANCE MEASURES

5 ENABLING THE MASTER PLAN

6 CASE STUDIES

FIGURE 53: MARGINAL SOCIAL COST OF ABATEMENT: CENTRAL SCENARIO, 2030 (REAL 2012 DOLLARS PER TONNE OF CO₂ EQUIVALENT EMISSIONS ABATEMENT (SOURCE: ALLEN CONSULTING GROUP)

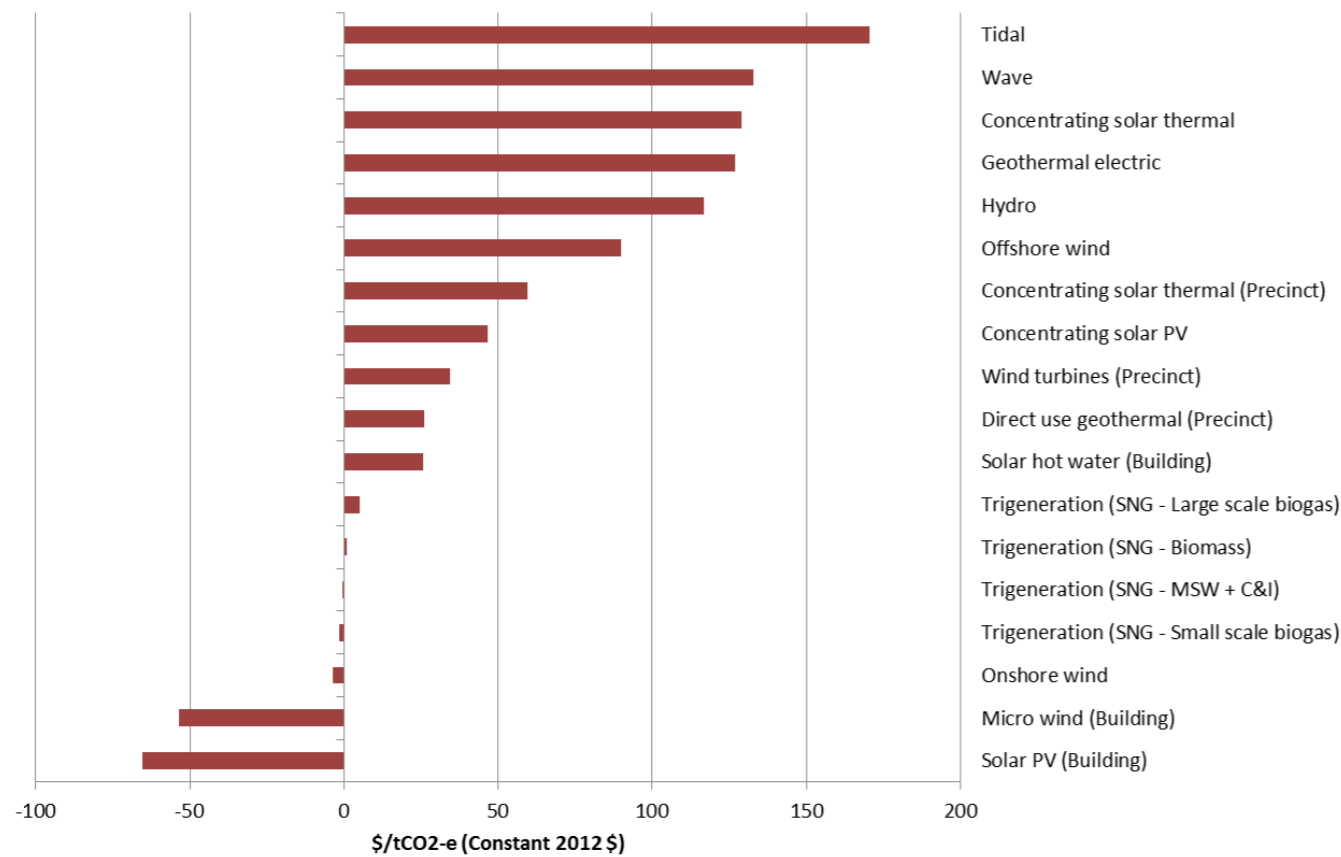

All renewable energy technologies costs reduce with large scale onshore wind energy joining micro wind, trigeneration supplied by renewable gases and solar PV as negative cost of carbon abatement technologies by 2030. However, only trigeneration supplied by renewable gases is a non intermittent renewable energy technology capable of supplying 100% (with solar PV and some large scale onshore wind energy) of the City of Sydney's LGA electricity, heating and cooling requirements without interruption by 2030.

This analysis compares the baseline scenario of providing electricity by the predominantly fossil fuel fired national electricity grid, against the scenario presented in this Master Plan for electricity to be supplied using renewable energy technologies.

There have been some significant developments recently which are improving the commercial viability of renewable energy compared to the baseline scenario of energy from predominately coal fired electricity generation. Firstly, the price of renewable energy technologies has fallen in recent years. Secondly, transmission and distribution charges and other costs associated with traditional centralised large scale energy supplies are increasing rapidly. Thirdly, the recent introduction of a carbon price has further assisted to reduce the gap between renewable and non-renewable energy costs.

1.

2.

3.

4.

5.

6.



ENABLING THE MASTER PLAN

ENABLING THE MASTER PLAN

The renewable energy technologies in this Master Plan will provide a range of transformative, clean and reliable energy solutions to the City of Sydney's Local Government Area, with lower greenhouse gas emissions. The solutions can be implemented at a cost that is practical and affordable when compared to the social costs of existing energy generation and supply systems. It also offers future-proof solutions that are capable of integration with new technologies and renewable gas for trigeneration.

Enabling widespread use of renewable energy technologies can be complex. The responsibility for implementing this Master Plan rests with the City of Sydney. However, the scale and range of technologies within this Master Plan cannot be implemented by the City of Sydney alone. Some of the City's renewable energy target will be implemented by existing actions such as the Australian Government's 20% renewable electricity target but

this Master Plan goes much further than existing actions currently under way. Facilitating the increased use of renewable energy technologies in the City of Sydney LGA over and above current government targets requires action on behalf of the residential and business communities, and the State and Federal Governments all working in cooperation with the City of Sydney.

This chapter outlines the necessary enabling actions needed to bring about a positive change. These have been framed to be complementary to the actions in the Trigenation Master Plan.

There is no single entity in the government or private sector that can implement the scale of renewable energy systems envisioned in this Renewable Energy Master Plan. It must be a shared responsibility implemented by all sectors of government as well as private business and industry.

- 1 REFORM THE BUILDING SUSTAINABILITY INDEX (BASIX) TO INCORPORATE RENEWABLE ENERGY IN THE CITY OF SYDNEY
- 2 REFLECT THE LOW CARBON INFRASTRUCTURE ZONES IN THE CITY'S DEVELOPMENT CONTROL PLAN
- 3 RECOGNISE PRECINCT SCALE DECENTRALISED RENEWABLE ENERGY IN MANDATORY DISCLOSURE AND NABERS
- 4 LOW CARBON ZONE RECOGNITION SCHEME
- 5 INCENTIVISE RENEWABLE ENERGY
- 6 STANDARDISE CONNECTION FEES FOR RENEWABLE ELECTRICITY AND GAS NETWORKS
- 7 INTRODUCE DEMAND MANAGEMENT REBATES AND COST REFLECTIVE NETWORK CHARGES
- 8 MAKE LOCAL, STATE AND FEDERAL FUNDS AVAILABLE FOR RENEWABLE ENERGY SYSTEMS
- 9 INTRODUCE ENVIRONMENTAL UPGRADE AGREEMENTS FOR NEW DEVELOPMENT
- 10 STRATEGY FOR INVESTMENT WITHIN AND BEYOND THE CITY BOUNDARIES
- 11 UNDERTAKE FEASIBILITY STUDIES AND DEMONSTRATION PROJECTS IN SUPPORT OF RENEWABLE ENERGY TECHNOLOGIES
- 12 REMOVE THE REGULATORY BARRIERS TO DECENTRALISED ENERGY
- 13 ESTABLISH RENEWABLE GAS TARGET AND DEVELOP REGULATORY REGIME FOR RENEWABLE GASES
- 14 IMPLEMENT A GOVERNMENT LED MARKET DEVELOPMENT APPROACH TO RENEWABLE GASES
- 15 DEVELOP 'POWER TO GAS' ENERGY STORAGE MECHANISM FOR INTERMITTENT RENEWABLE ELECTRICITY
- 16 UNDERTAKE FULL RENEWABLE GAS AND 'POWER TO GAS' STUDIES IN NSW AND AUSTRALIA
- 17 DEVELOP AND IMPLEMENT COMMUNITY RENEWABLE ENERGY AND OTHER ASSOCIATED APPROPRIATE ACTIONS TO ENABLE THE CITY'S COMMUNITY TO HELP THE CITY OF SYDNEY DELIVER THE RENEWABLE ENERGY MASTER PLAN

1 RENEWABLE ENERGY RESOURCES

2 RE-THINKING RENEWABLE ENERGY

3 RENEWABLE ENERGY FOR THE CITY OF SYDNEY

4 PERFORMANCE MEASURES

5 ENABLING THE MASTER PLAN

6 CASE STUDIES

1.

REFORM THE BUILDING SUSTAINABILITY INDEX (BASIX) TO INCORPORATE RENEWABLE ENERGY IN THE CITY OF SYDNEY

Greenhouse gas compliance targets for all new multi-unit residential construction under NSW Building Sustainability Index (BASIX) should be lifted from 20 to a minimum of 60 within the City of Sydney LGA. The revised BASIX target to be achieved using renewable energy in conjunction with other measures, such as energy efficiency and/or trigeneration/domestic fuel cell cogeneration.

BASIX is already configured to operate with different reduction targets across NSW depending on location and building type. The operating system could easily be configured to identify the City of Sydney LGA, as it presently does, for reticulated recycled water schemes where they exist in NSW.

The renewable energy systems in conjunction with other measures such as energy efficiency and/or trigeneration are an effective way of providing greenhouse-free energy to new residential construction and facilitate cost-effective BASIX compliance.

2.

REFLECT THE LOW CARBON INFRASTRUCTURE ZONES IN THE CITY'S PLANNING CONTROLS

The City's Planning Controls should be modified to incorporate mandatory renewable energy targets for new developments. All new building developments (over 1000m² or a high energy use development) should be required to achieve a 10% reduction in greenhouse gas emissions to be met by on-site or precinct scale renewable energy. This should increase to a 20% reduction in greenhouse gas emissions to be met by on-site or precinct scale renewable energy within 5 years of the introduction of the new policy.

This policy would incentivise energy hierarchy emission reductions by:

- Cost-effective energy efficiency
- Decentralised energy
- Cost-effective renewable energy

This is a subtle shift from an energy led policy to an emission led policy. Mandatory renewable energy targets in the planning regime are an effective policy mechanism to increase the uptake of renewable energy in new development.

The first prescriptive planning policy for renewable energy in the world was by the London Borough of Merton in the UK in 2003. It adopted a mandatory planning policy requiring new development to source 10% of their energy needs from onsite renewable energy. This was referred to as the 'Merton Rule'. The London Plan 2008 required all new developments referred to the Mayor of London to achieve a 20% reduction in carbon dioxide emissions from on site or near site renewable energy.

3.

RECOGNISE PRECINCT SCALE DECENTRALISED RENEWABLE ENERGY IN MANDATORY DISCLOSURE AND NABERS

Precinct scale decentralised renewable energy must be recognised under the Federal Government's mandatory Commercial Buildings Disclosure legislation.

All sellers or lessors of commercial property of 2,000m² or more are required to obtain and disclose an up-to-date Building Energy Efficiency Certificate (BEEC). This includes the building's NABERS rating.

Mandatory disclosure of a building's energy efficiency performance has the potential to create demand for low or zero emissions buildings by allowing buyers and tenants to compare the relative performance of different buildings. However, mandatory disclosure does not require the emissions of a building to be disclosed. Mandatory disclosure would also create an incentive for building owners to connect to a precinct scale renewable energy network.

The NABERS ruling in July 2010 supported the use of precinct or district trigeneration systems when performing a NABERS assessment of a building connected to a decentralised energy network under which a precinct scale renewable energy system could have operated. However, NABERS overturned its July 2010 ruling in October 2012 creating an additional barrier to decentralised or precinct scale renewable energy.

As NABERS has overturned its July 2010 ruling precinct scale decentralised renewable energy would by default be artificially classified as predominantly coal-fired grid electricity since precinct scale decentralised energy systems by their nature are not mounted on an individual building and as distributed generation do not form part of the National Electricity Market or accounted for in the National Greenhouse Gas Accounts Factors.

Mandatory disclosure and NABERS should recognise in their ratings the surplus zero carbon electricity, heating and cooling from precinct scale decentralised renewable energy supplying other buildings in the precincts. Recognition of the surplus zero carbon electricity from precinct scale decentralised renewable energy or renewable fuelled trigeneration and the associated ratings of supplied buildings can be administered through a decentralised energy plan for new development such as Barangaroo or through a published decentralised energy plan such as the City of Sydney's Decentralised Energy Master Plan – Renewable Energy.

1.

2.

3.

4.

5.

6.

4.

LOW CARBON ZONE RECOGNITION SCHEME

City of Sydney should establish a recognition scheme to recognise and differentiate buildings which have connected to a precinct-based renewable energy system (which can form part of a precinct-based trigeneration system).

This could include recognition on the City of Sydney's website and the development of public materials to assist property agents searching for green buildings. This could also be used to incentivise and recognise buildings in the Low Carbon Infrastructure Zones or Precincts.

5.

INCENTIVISE RENEWABLE ENERGY

Establish a premium rate for renewable electricity and renewable gases.

The NSW State Plan 2021 has established a target of 20% renewable energy use across the State by 2020. This is consistent with the Australian Government's Renewable Energy Target (RET) scheme to deliver 20% electricity supply from renewable sources. It aims to deliver a 45,000 GWh target in 2020.

The RET scheme operates as two separate parts, supporting both large scale projects such as wind farms, commercial solar and geothermal power stations, and small scale projects such as rooftop solar panels and solar water heaters.

The State Government intends to contribute to the national renewable energy target by promoting energy security through a more diverse energy mix, reducing coal dependence, increasing energy efficiency and moving to lower emission energy sources. This would include renewable energy technologies.

6.

STANDARDISE CONNECTION FEES FOR RENEWABLE ELECTRICITY AND GAS NETWORKS

Establish standards for grid transmission and distribution connection fees. Uncertainty regarding potential fees for connecting to the electricity and gas networks is a barrier to greater adoption of renewable energy technologies. This provides a simple way to reduce that uncertainty.

Additional charges for augmentation when connecting renewable energy to the electricity and gas networks may place high financial burdens on renewable electricity and gas connections, and ultimately to the connected customers as the cost is passed on.

1 RENEWABLE ENERGY RESOURCES

2 RE-THINKING RENEWABLE ENERGY

3 RENEWABLE ENERGY FOR THE CITY OF SYDNEY

4 PERFORMANCE MEASURES

5 ENABLING THE MASTER PLAN

6 CASE STUDIES

7.

INTRODUCE DEMAND MANAGEMENT REBATES AND COST REFLECTIVE NETWORK CHARGES

Establish demand management rebates or offsets where demand on the electricity or gas grid network is avoided. Local generation can assist in the management of transmission and network demand.

Avoided transmission costs are a potential source of revenue that could help ensure the viability of the renewable energy technologies considered in this Renewable Energy Master Plan.

Connected users that receive electricity from closely located generators (such as wind turbines) are currently charged full distribution charges by the network operator. The reduced transportation of electricity over the network should be reflected in lower cost reflective distribution charges. This would provide a clear price benefit that could be used to incentivise building operators to use renewable energy technologies, especially building scale systems and precinct scale renewable power plants in the city.

8.

MAKE LOCAL, STATE AND FEDERAL FUNDS AVAILABLE FOR RENEWABLE ENERGY SYSTEMS

Introduce measures to reduce the costs of retrofitting building scale technologies to existing buildings and precinct scale renewable power plants within and in proximity to the city, including subsidies and contributory grants. The private sector should contribute the majority of the project finance with the public sector finance being used to make up any economic shortfall.

This would be a competitive process based on the public sector's grant or contribution cost of carbon abatement. Subsidies and grants should be targeted to those technologies or mix of technologies that address:

- Intermittency and the minimisation or elimination of coal-fired spinning reserve
- Peak power
- Additional benefits such as reduction in waste going to landfill
- Economic benefits to rural communities.

In this way, public sector finance of renewable energy projects would go much further. It would enable better public sector financial management as the grants would be fixed and target those technologies or mix of technologies that would deliver greater non intermittency and security of supply outcomes. Higher grants would be available for those technologies, such as marine renewables and renewable gases from waste, which deliver these and other benefits.

The public sector should take the lead by investing resources into renewable energy on its own buildings and operations.

For building scale technologies, the rate of uptake by building owners depends on whether appropriate incentive mechanisms can be developed at all levels of Government.

For precinct scale renewable power plants within the City of Sydney LGA and within close proximity to the LGA, the City of Sydney may be able to directly contribute or incentivise installations through investment, partial investment, support for community renewable schemes, land offers or rate concessions, as appropriate, to contribute towards the City's renewable energy targets.

9.

INTRODUCE ENVIRONMENTAL UPGRADE AGREEMENTS FOR NEW DEVELOPMENT

The Local Government (Environmental Upgrade Agreement) Act 2010 enables financing for energy efficiency retrofits in non residential and strata multi residential buildings and can include building integrated or precinct scale renewable energy. This makes it easier for building owners and occupiers to provide or connect to renewable energy systems. However, Environmental Upgrade Agreements should be extended to new developments to incentivise developers to provide or connect to renewable energy systems.

1.

2.

3.

4.

5.

6.

10.

STRATEGY FOR INVESTMENT WITHIN AND BEYOND THE CITY BOUNDARIES

A strategy for investment in renewable energy within the city will need to be developed. This may take the form of community investment similar to the community shareholding schemes in Denmark.

Not all the renewable energy targets identified in this Master Plan can be met with renewable energy sourced from within the City of Sydney boundaries.

A strategy for investment in renewable energy beyond the city will need to be developed. The renewable energy resources and technologies detailed in this Master Plan comprise renewable electricity and renewable gases for use on the trigeneration network.

The criteria below could be used to evaluate and prioritise projects:

1. Contribution towards the City's renewable electricity target.
2. Contribution towards the City's trigeneration renewable gases requirements.
3. Contribution towards the City's reduction in greenhouse gas emissions target.
4. Cost of carbon abatement.
5. Other benefits that could be delivered by the technology.
6. Level of intermittency or non-intermittency of energy generation.
7. Level of impact or non impact on fossil fuel spinning reserve.
8. Level of impact or non impact on network charges paid by consumers.

Investment decisions will depend on the City's ability to claim the energy and emissions savings for the City of Sydney LGA without double counting. This strategy could also identify mechanisms for businesses and residents within the city to contribute.

11.

UNDERTAKE FEASIBILITY STUDIES AND DEMONSTRATION PROJECTS IN SUPPORT OF RENEWABLE ENERGY TECHNOLOGIES

Feasibility studies need to be an ongoing part of supporting renewable energy systems to be implemented in the City of Sydney, ensuring the long-term viability of renewable energy solutions. Obstacles exist at many different levels. Feasibility analysis must be carefully targeted and prioritised in order to overcome such barriers in the most cost-effective way. For example:

- Further investigation into the conversion and transportation mechanisms for renewable gases is required from the conversion plant to the City of Sydney.
- Site identification and selection studies should be conducted in order to identify potential sites for renewable energy such as concentrating solar thermal plants and direct use geothermal within the city.

This will enable more reliable estimates to be made of the extent to which these technologies can contribute to the Master Plan's targets.

Demonstration projects are important in setting standards and showing that potential projects can be implemented in practice. No amount of feasibility studies can match a real project on the ground. This could be achieved through the City of Sydney's \$10 million renewable energy fund, or the identification of significant building scale renewable energy projects.

Priority should be given to the importance of renewable gases delivering beyond the 30% renewable electricity target.

1 RENEWABLE ENERGY RESOURCES

2 RE-THINKING RENEWABLE ENERGY

3 RENEWABLE ENERGY FOR THE CITY OF SYDNEY

4 PERFORMANCE MEASURES

5 ENABLING THE MASTER PLAN

6 CASE STUDIES

12.

REMOVE THE REGULATORY BARRIERS TO DECENTRALISED ENERGY

Removal of the regulatory barriers to decentralised energy will enhance the financial and greenhouse performance of decentralised energy and distributed generation (including cogeneration, trigeneration, fuel cells and renewable energy) more broadly.

The City of Sydney's submissions to the Prime Minister's Task Group on Energy Efficiency on 30 April 2010 and NSW Inquiry into Cogeneration and Trigeneration on 2 September 2013 calls for the removal of regulatory barriers that could affect the optimal financial performance of decentralised energy within the City of Sydney and elsewhere.

This follows the removal of the regulatory barriers to decentralised energy in the United Kingdom on 19 March 2009. The UK has a similar electricity trading system to Australia and the regulatory barriers were overcome by a simple electricity licence modification issued by the UK regulator. The Office of Electricity and Gas Markets effectively licensed Energy Services Companies to generate, distribute and supply electricity over the local public wires distribution network on the 'virtual private wires over public wires' principle.

This principle removed the costs of trading electricity in the national electricity market, that is, the transmission grid. It replaced it with a decentralised electricity trading system with costs commensurate with the size of the decentralised energy system.

The electricity retail exemptions should also be modified to enable small scale decentralised energy systems to generate, distribute and supply electricity without having to participate in the national electricity market. An exempt electricity licence regime will be particularly important for implementing smaller precinct scale renewable energy.

A common pricing methodology for electricity networks, which reflects the positive benefits of decentralised electricity generation needs to be introduced. Specifically, decentralised electricity generators to be offered a positive (credit) network tariff for feeding electricity into local networks.

The scale of this credit (which takes the form of a negative decentralised generation use of system charge) to be calculated on the level of benefit that each network receives from local generation. Non-intermittent technologies such as precinct trigeneration or renewable energy to be generally recognised as providing the highest level of benefit to networks.

The United Kingdom introduced such a common pricing methodology for electricity networks called the 'Common Distribution Charging Methodology' on 1 April 2010 setting in place the positive (credit) network tariff for each type of distributed generator at each voltage level feeding electricity into distribution networks. The scale of credit also takes into account the scale of intermittency or non-intermittency of the distributed generator and provides a decentralised energy proponent with certainty upfront as to the tariff it will receive. As the tariff is in recognition of deferred network investment, it is equitable for existing users of the distribution system.

13.

ESTABLISH RENEWABLE GAS TARGET AND DEVELOP REGULATORY REGIME FOR RENEWABLE GASES

Australian and NSW Governments should establish a target of 20% renewable gas similar to the Renewable Electricity Target and implement gas regulatory reform to enable gas purchase agreements between renewable gas generators and customers and a national accreditation program for GreenGas similar to power purchase agreements and GreenPower for renewable electricity.

Development of a regulatory regime for renewable gases will remove regulatory barriers to renewable gases and enhance the financial, security of supply and greenhouse performance of decentralised energy (cogeneration, trigeneration and renewable energy), renewable heat, renewable energy for transport and energy storage.

The regulatory regime for renewable gases should be designed to ensure that renewable gases are only used to supply decentralised energy (cogeneration, trigeneration and fuel cells), renewable heat and transport applications to maximise the efficiency and reductions in greenhouse gas emissions of the renewable gas market. Renewable gases should not be used for power generation only or form part of the conventional domestic gas market.

Renewable energy targets for renewable gas, renewable heat, renewable fuels for transport and renewable 'power to gas' energy storage should also be adopted by State and Federal Governments in addition to the Renewable Electricity Target.

In order to support this regulatory reform should also ensure that renewable gas is treated differently to and incentivised over natural gas. Renewable gas should be granted preferred network access to the gas grid, preferred network entry by gas grid operators and extended accounting balance for transport applications to stimulate the renewable gas market.

In Germany, the Renewable Energy Sources Act 2009 (Erneuerbare-Energien-Gesetz, EEG) and the Renewable Energies Heat Act 2009 set in law that 14% of German heat demand is to be produced from renewable energy sources. This includes renewable gases, biomass and solar thermal and geothermal heat or the cogeneration of heat and electricity from renewable sources. Under German law renewable gas can only be used by decentralised energy (cogeneration/trigeneration), renewable heat or transport applications. Renewable gas cannot be used for electricity generating only power stations or the general domestic gas market. This is to maximise energy efficiency and emissions reduction and to prevent 'price gouging' where renewable gas is cheaper than fossil fuel natural gas.

The Gas Network Access Ordinance was also amended to ensure that the charging of transmission and distribution tariffs do not discriminate against renewable gas and to extend the existing gas grid to facilitate the integration of gas from renewable sources (*Article 6 of European Directive 2003/55/EC*). The Ordinance also ensures that renewable gas is granted preferred network access to the gas grid, preferred network entry by gas grid operators and extended accounting balance for transport applications.

Germany now has more than 7,000 renewable gas generators and since 2009 more than 170 renewable gas grid injection plants injecting more than 8.5 billion kWh a year of renewable gas into the gas grid network against the EEG target to exploit a minimum 60 billion kWh of renewable gas by 2020 and a minimum 100 billion kWh of renewable gas by 2030 demonstrating the speed of action that can be delivered with good energy policy and regulation. Notwithstanding the minimum EEG targets the German Government expects that by 2030, up to 650 billion kWh of primary energy could be delivered by renewable gases, with 370 billion kWh from biogas and 280 billion kWh from syngas and other renewable gases.

1.

2.

3.

4.

5.

6.

14.

IMPLEMENT A GOVERNMENT LED MARKET DEVELOPMENT APPROACH TO RENEWABLE GASES

In order to develop the renewable gases market State and/or Federal Government should implement regulatory reform to develop and implement a market led platform for renewable gas grid injection that could deliver a cost effective non intermittent renewable energy market in the near term.

This should be in collaboration with industry partners spanning the entire value chain of renewable gases. The collaboration market-led approach will supplement the efforts of Australian Governments to establish the injection of renewable gas into the natural gas grid as a fixed component of the future energy mix.

The injection of renewable gases into the gas grid offers added value at many levels: municipal, commercial, industrial and biomass feedstock provision, decarbonising waste disposal through the minimisation of waste going to landfill, carbon farming, generation, processing, marketing, transportation, distribution and application in the electricity, heat and transport sectors. Both technical and economic optimisation will exist at each of these stages in the value chain and could develop Australia as one of the world leaders in renewable gases.

In order to support regulatory reform and a market led approach to developing a renewable gas market in Germany the German Energy Agency (Deutsche Energie-Agentur, DENA) developed the 'biogaspartner' project. The aim of the project was to develop an industry platform for renewable gas injected into the gas grid and the utilisation of injected renewable gases. More than 60 stakeholders have so far joined the project spanning project development, engineering, plant engineering, plant operation, trade, energy supply companies, application, financing, consulting, research and associations. The renewable gas industry currently employs 11,000 people, mainly in rural areas, and 5-10% of farm income is generated from renewable gas generation.

15.

DEVELOP 'POWER TO GAS' ENERGY STORAGE MECHANISM FOR INTERMITTENT RENEWABLE ELECTRICITY

If solar and wind are to provide ever increasing amounts of electricity to the electricity grid the intermittency of such technologies will need to be overcome. The fact that solar cannot generate electricity at night time or that wind cannot generate electricity if there is little or no wind is well known but what is less well known is that solar and wind, particularly wind, can at times generate more electricity than demand and renewable electricity generators have to be switched off to prevent this from happening.

The switching off of renewable electricity generators to prevent over generation will become an increasing problem with the growth of intermittent renewable electricity generation but surplus renewable electricity that would otherwise have to be switched off also provide an opportunity to overcome the intermittency of renewable electricity generation.

Development of a 'power to gas' energy storage mechanism for intermittent renewable electricity generation, such as solar and wind, will enable surplus renewable electricity at times of over generation to be stored in the gas grid and utilised at another time instead of using expensive electricity storage.

Converting renewable electricity to renewable gas is a new way of storing surplus energy from renewable sources, such as solar and wind, until it is required, balancing long term fluctuations in generation and removing the link between generation and demand.

Germany is one of the first countries in the world to install 'power to gas' technologies injecting surplus wind power that would otherwise be switched off, into the gas grid. Using this mechanism means that Germany's current entire renewable electricity output could be stored in the existing German gas grid. This will make the German gas grid an energy storage system for renewable electricity from weather-dependent renewables which will significantly improve the economics, efficiency and utilisation of renewable energy. For example, converting low value off peak renewable electricity into high value renewable gas in the gas grid.

Total existing gas storage facility capacity in the Eastern Australian gas market exceeds 150PJ, which is the equivalent of storing 41,700GWh of renewable electricity, more than 90% of the entire Australian Mandatory Renewable Electricity Target of 45,000GWh by 2020.

1 RENEWABLE ENERGY RESOURCES

2 RE-THINKING RENEWABLE ENERGY

3 RENEWABLE ENERGY FOR THE CITY OF SYDNEY

4 PERFORMANCE MEASURES

5 ENABLING THE MASTER PLAN

6 CASE STUDIES

16.

UNDERTAKE FULL RENEWABLE GAS AND 'POWER TO GAS' STUDIES IN NSW AND AUSTRALIA

Not all of the renewable gas feedstocks within 250km of the City of Sydney LGA were captured in this Master Plan. For example, it excluded food processing waste, meat processing waste, other forestry residues and overlapping local authorities such as Shoalhaven. Therefore, a full renewable gas study should be undertaken for these renewable gas feedstocks as well as renewable gas feedstocks beyond the 250km proximity zone from the City of Sydney LGA.

A full renewable energy study should also be undertaken in NSW and Australia to determine the full renewable energy potential of Australia, not just to supply renewable energy to Australia but also the renewable energy mining export potential, including off shore marine renewables, utilising 'power to gas' technologies.

Although the potential for these renewable energy resources are identified in this Master Plan both of these studies were beyond the scope of this Master Plan.

17.

DEVELOP AND IMPLEMENT COMMUNITY RENEWABLE ENERGY AND OTHER ASSOCIATED APPROPRIATE ACTIONS TO ENABLE THE CITY'S COMMUNITY TO HELP THE CITY OF SYDNEY DELIVER THE RENEWABLE ENERGY MASTER PLAN

As part of the City's research into world renewable energy best practice a key component of how countries were delivering such a large proportion of renewable energy generation was community renewable energy. In Denmark, nearly 50% of domestic electricity demand and 80% of thermal energy demand (heating and cooling) is owned by the customers themselves in one form or the other.

In Germany, 65% of renewable energy generation, some 35,000MW, is owned by the customers themselves either as individuals or as cooperatives. The rapid roll out of renewable energy in Germany is now nearly three times the installed nuclear capacity in 2010 and five times installed nuclear capacity in 2011 (after Germany's nuclear phase-out decision). Even in the UK, there has been a rapid growth in community owned self-generation from 6% in 2011 to 15% in 2013.

To support this an implementation plan to develop and implement community renewable energy and other associated actions will need to be developed to enable the City's community to help the City of Sydney deliver the Renewable Energy Master Plan. In order to deliver the Master Plan targets the implementation plan will need to cover community renewable energy schemes both within and beyond the City's LGA.

1.

2.

3.

4.

5.

6.

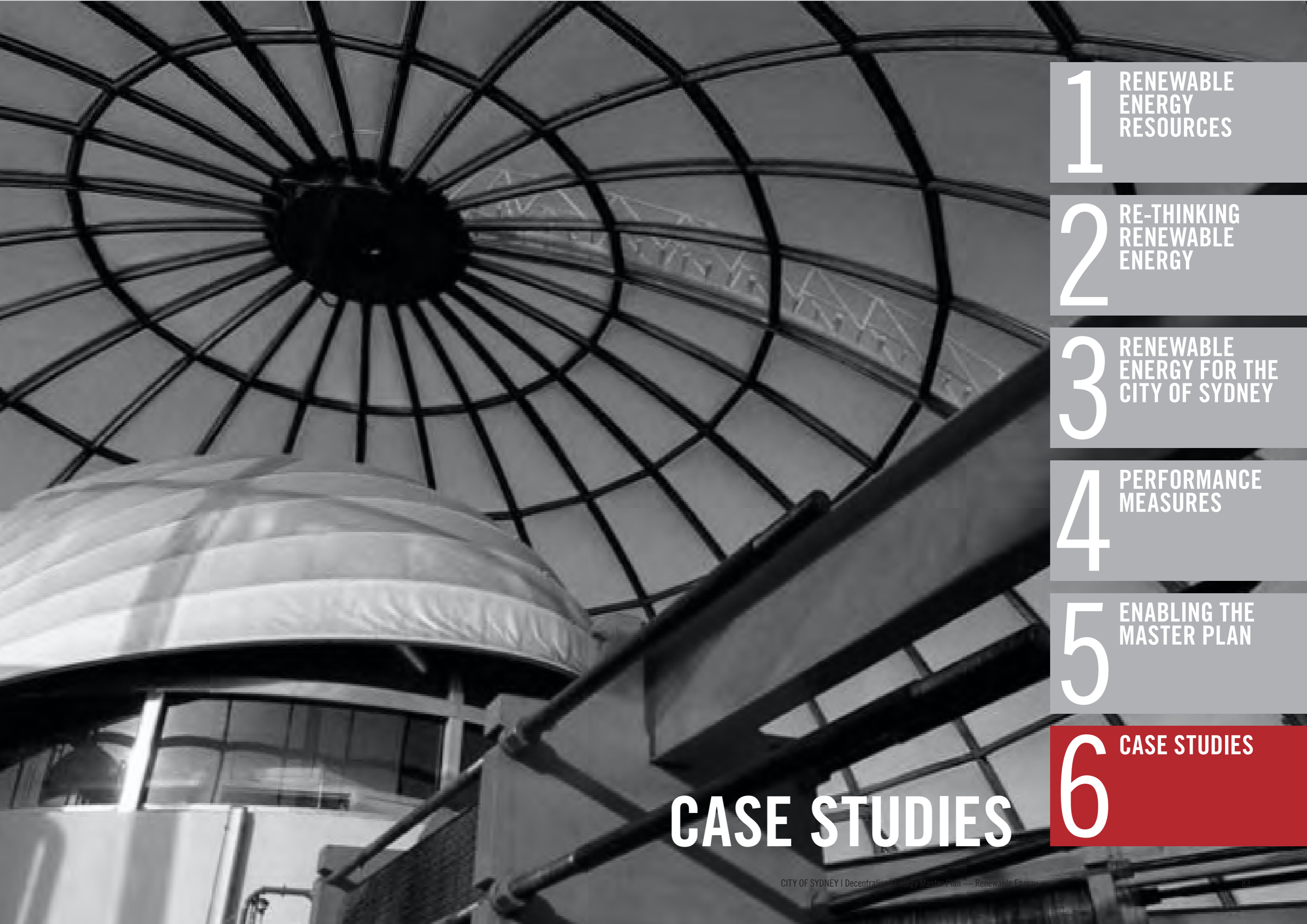

1 RENEWABLE ENERGY RESOURCES

2 RE-THINKING RENEWABLE ENERGY

3 RENEWABLE ENERGY FOR THE CITY OF SYDNEY

4 PERFORMANCE MEASURES

5 ENABLING THE MASTER PLAN

6 CASE STUDIES

CASE STUDIES

CASE STUDIES

BUILDING SCALE TECHNOLOGIES

SOLAR PHOTOVOLTAICS SYDNEY TOWN HALL

Sydney Town Hall is an architectural and historic icon. The building is heritage listed so the photovoltaics (PV) design was sympathetically designed to the Town Hall's form and character.

High efficiency PV cell panels were installed on the heritage slate roof. Installation of the panels was carefully considered to ensure no impact to the building using engineered mounting frames. This innovative mounting system cost less than budgeted, and therefore, more panels were able to be added to the system. Power generated from this project is used by Sydney Town Hall and Town Hall House.

<i>Capacity:</i>	<i>48kWp</i>
<i>Annual output:</i>	<i>60MWh pa</i>
<i>Solar panels:</i>	<i>240</i>
<i>Annual saving:</i>	<i>62.4 tonnes CO_{2-e}</i>

SOLAR PHOTOVOLTAICS SYDNEY THEATRE COMPANY

Sydney's Wharf Theatre has installed nearly 2,000 solar panels that cover the entire roof. This is enough energy to power 70% of the theatre's energy demands, along with practical electricity saving measures.

Currently, this is the largest installation in Sydney and the second largest rooftop installation in Australia. The roof panels are highly visible to promote community awareness and to encourage and demonstrate practical actions to assist sustainability.

The rooftop at Sydney Theatre Company gained recognition as a world-leading sustainable creative hub. Commercial scale rooftop solar farms of this kind are becoming more commonplace in Australia

<i>Capacity:</i>	<i>384kWp</i>
<i>Annual Output:</i>	<i>530MWh pa</i>
<i>Solar panels:</i>	<i>1,906 solar panels</i>
<i>Annual saving:</i>	<i>562 tonnes CO_{2-e}</i>

FIGURE 54: SOLAR PHOTOVOLTAIC ROOF SYDNEY TOWN HALL
SOURCE: CITY OF SYDNEY



FIGURE 55: SOLAR PHOTOVOLTAIC ROOF SYDNEY THEATRE COMPANY
SOURCE: NSW GOVERNMENT



BUILDING SCALE TECHNOLOGIES

SOLAR THERMAL HOT WATER, REDFERN COMMUNITY CENTRE, SYDNEY

The City of Sydney Council has installed solar thermal hot water systems on many of its Council owned buildings in the city. The solar thermal evacuated tube solar pre-heat systems are an Australian invention. The systems can be installed on residential and commercial buildings and are easy to retrofit to existing hot water systems on buildings.

The water in the tubes is heated by the sun aided by insulation material and specialised coating that absorbs heat but does not release it back to the atmosphere. As the tubes are round in shape, the sun's rays can be captured throughout the whole day.

A heat pipe in the centre of each tube is used to heat the water which converts it to steam gas to deliver heat. The buildings supply of cold water is then circulated to absorb this solar heat and delivered back to a storage tank. Once it has released its heat, the fluid flows back to the collectors to be reheated again. This fluid keeps circulating whenever there is heat available in the solar collectors. This constant provision of hot water has the benefit of reducing the energy demand.

<i>Capacity:</i>	<i>315 litres triple 4.8kW</i>
<i>Collector Area:</i>	<i>8.5 m²</i>
<i>Hot water storage:</i>	<i>945 litres</i>
<i>Daily hot water usage:</i>	<i>1,000 litres at 50°C</i>
<i>Energy saving:</i>	<i>42,015MJ pa gas & 11,671kWh pa electricity</i>
<i>Annual saving:</i>	<i>12.4 tonnes CO_{2-e}</i>

FIGURE 56: SOLAR THERMAL HOT WATER, REDFERN COMMUNITY CENTRE, SYDNEY
SOURCE: CITY OF SYDNEY



MICRO WIND TURBINE, INMARK TOWER, SYDNEY

Micro wind turbines can be installed on buildings both vertically and horizontally. Inmark Tower at 710 George Street in the centre of Sydney was the first urban wind turbine installed in the City of Sydney LGA. It has a vertical axis turbine. The building is a 35 storey high rise residential with retail and commercial space. A frame around the turbine is a visual aesthetic and not a feature of the turbine.

Power generated from the turbine feeds back into the building's own electricity supply, primarily to run the common areas such as corridors, lobbies and stair lighting.

<i>Capacity:</i>	<i>4kW</i>
<i>Start-up wind speed:</i>	<i>3–5 m/s</i>
<i>Shut off wind speed:</i>	<i>25 m/s</i>
<i>Annual output:</i>	<i>11MWh pa</i>
<i>Annual saving:</i>	<i>11.6 tonnes CO_{2-e}</i>

FIGURE 57: MICRO WIND TURBINE, INMARK TOWER, SYDNEY
SOURCE: SYDNEY ARCHITECTURE



1 RENEWABLE ENERGY RESOURCES

2 RE-THINKING RENEWABLE ENERGY

3 RENEWABLE ENERGY FOR THE CITY OF SYDNEY

4 PERFORMANCE MEASURES

5 ENABLING THE MASTER PLAN

6 CASE STUDIES

1.

BUILDING SCALE TECHNOLOGIES

SOLAR THERMAL COOLING AND HEATING, ESSLINGEN, GERMANY

The solar thermal system supplying the Festo AG & Co. KG head offices in Esslingen-Berkheim runs a large solar adsorption cooling and heating system.

The principle of solar cooling is to utilise the solar energy that is available in abundance during the hot months that is in direct proportion to the need to cool buildings. Unlike solar electricity, which can only provide a fraction of the electricity requirements of conventional electric air conditioning chillers, solar thermal energy can run an air conditioning system in full and can be easily stored in a thermal store to run an conditioning system at subsequent times of low light levels or during the hours of darkness. The combination of solar thermal energy and thermal storage can therefore, overcome the intermittency of solar energy.

The Esslingen solar thermal cooling and heating system cools 26,760m² of office space plus three atriums with an area of 2,790m², utilising solar vacuum tube collectors on the roof via three adsorption chillers. The system is supported by thermal storage, waste heat from compressors and gas fired back up boilers.

The adsorption chillers use water as a refrigerant which is drawn from the cold water circuit and is therefore zero Ozone Depletion Potential and zero Global Warming Potential. Adsorption chillers require only low temperature levels and are particularly suitable for operation with heat from solar thermal systems. The degree of solar utilisation depends on the temperature level of the system and is higher when the temperatures are low. In winter, when the offices do not need cooling, the solar thermal energy is used in support of heating the building. The water is prevented from freezing in sub-zero temperatures by hot water being pumped from the thermal storage into the solar collectors upon requirement.

<i>Capacity:</i>	<i>1.2MWth</i>
<i>Annual Output:</i>	<i>500MWh pa</i>
<i>Solar panels:</i>	<i>1,330m²</i>
<i>Thermal Storage:</i>	<i>17m³</i>
<i>Annual saving:</i>	<i>435 tonnes CO_{2-e} (based on Germany grid emissions)</i> <i>530 tonnes CO_{2-e} (based on NSW grid emissions)</i>

FIGURE 58: SOLAR THERMAL COOLING AND HEATING, ESSLINGEN, GERMANY
SOURCE: SOLARSERVER



2.

3.

4.

5.

6.

BUILDING SCALE TECHNOLOGIES

GEOTHERMAL HEAT PUMP, EMBASSY COURT, LONDON, UK

Embassy Court is an 8-storey residential building located in St Johns Wood comprising 25 luxury apartments, including two large penthouse duplexes.

The ground source geothermal heat pump system provides heating and cooling to the apartments from a central plant room plus a dry cooler for additional cooling. The energy piles and vertical closed loop system extracts low temperature thermal energy from the ground and increases this temperature using heat pumps with a coefficient of performance of 4.8 (heating mode) and 5.8 (cooling mode).

Heating and cooling are achieved by moving a refrigerant through various indoor and outdoor coils and components. Each heat pump system comprises a compressor, condenser, expansion valve and evaporator which are used to change the state of refrigerant from a liquid to hot gas and from a gas to cold liquid.

Drilling and groundworks are a key part of a ground source geothermal heat pump system and the utilisation of energy piles in the structural piles as part of the construction of the new building in an urban dense part of London was critical to the success of the project and a good demonstration project for city centres. Precision drilling was also required as the building lies close to the London Underground.

In order to reduce the thermal energy load the building was designed to make good use of winter solar gain and enhanced insulation and high performance low emissivity double glazing was used to reduce the heat loss in winter and solar gain in summer. The geothermal heat pump system provides 40% of the thermal energy load of the building and reduces greenhouse gas emissions by 16%.

Geothermal heat pump systems are a partial renewable energy technology since they use grid electricity to power the heat pumps and emission savings will depend on the carbon intensity of the electricity grid. Therefore, emission savings are lower in New South Wales (NSW) than in the UK since the carbon intensity of the NSW electricity grid is nearly twice that of the UK.

Care should also be taken in specifying low or zero Global Warming Potential (GWP) natural refrigerants for geothermal heat pump systems since conventional high GWP HFC refrigerants will increase overall greenhouse gas emissions.

Capacity:	202kW heating / 371kW cooling
Annual Output:	166,155kWh pa
Bores:	100 piles and boreholes / 40m depth
Annual saving:	98 tonnes CO _{2-e} (based on UK grid emissions) 82 tonnes CO _{2-e} (based on NSW grid emissions)

FIGURE 59: EMBASSY COURT – HEATING AND COOLING FROM GEOTHERMAL HEAT PUMP SYSTEM
SOURCE: BUILDING.CO.UK



1 RENEWABLE ENERGY RESOURCES

2 RE-THINKING RENEWABLE ENERGY

3 RENEWABLE ENERGY FOR THE CITY OF SYDNEY

4 PERFORMANCE MEASURES

5 ENABLING THE MASTER PLAN

6 CASE STUDIES

1.

BUILDING SCALE TECHNOLOGIES

BUILDING INTEGRATED WIND TURBINES, STRATA SE1, LONDON, UK

Strata SE1, otherwise known as the 'Razor' building, is a 148m high 43-storey residential building located in the Elephant & Castle Energy Action Area. The residential apartment building houses 1,000 people in 408 homes.

The residential tower contains three building integrated wind turbines erected in the top of the building where wind speeds are significantly higher than at street level. To reduce noise, the 19kW turbines have five blades instead of the usual three blades and are fitted with anti-vibration measures. Unlike conventional wind turbines the turbines use the Venturi effect to suck wind in from many angles and accelerate the wind through the tubes. This enables the turbines to run 24 hours a day, even at low wind speeds.

The 9 metre diameter wind turbines are designed to generate 50MWh pa which will supply 8% of the building's electricity demand. The building also incorporates other green features such as natural ventilation, high performance glazing and other energy efficiency measures that will maintain the building's electricity use 6% below the current UK building regulations requirements. The building also exceeds by 13% the current UK building regulations relating to sustainability, reducing overall carbon emissions by 15% lower than the Mayor of London's good practice benchmark.

The building will also be connected to the Elephant & Castle low carbon infrastructure zone precinct scale renewable fuelled trigeneration and recycled water networks which will achieve a predicted 73.5% reduction in CO₂ emissions when measured against the UK building regulations benchmark.

<i>Capacity:</i>	<i>19kW</i>
<i>Optimal Wind speeds:</i>	<i>8m/s to 16m/s</i>
<i>Annual Output:</i>	<i>50,000kWh pa</i>
<i>Annual saving:</i>	<i>29.5 tonnes CO_{2-e} (based on UK grid emissions)</i> <i>53 tonnes CO_{2-e} (based on NSW grid emissions)</i>

FIGURE 60: STRATA SE1 BUILDING INTEGRATED WIND TURBINES, LONDON, UK
SOURCE: SKYSCRAPERCITY



2.

3.

4.

5.

6.

PRECINCT SCALE TECHNOLOGIES

PRECINCT SCALE SOLAR PV PROGRAM, CITY OF SYDNEY

In 2010 the City approved a new plan to utilise the GreenPower budget to invest \$2M a year to build more renewable energy into the City's own buildings and operations rather than spend this money on purchasing GreenPower carbon offsets. The City retains its carbon neutral status with the purchase of more cost effective alternative accredited carbon offsets.

A \$10 million solar photovoltaics programme was initially approved to install 0.75 to 1.0MWp of solar PV to complement the City's proposed trigeneration project.

The request for tender specification was based on an output performance specification which included all 230 of the City's buildings to enable tenderers to select the best performing solar PV projects and to allow innovation to bring down the cost of solar PV and to maximise the generation of solar electricity and reductions in greenhouse gas emissions which was required to be guaranteed under the contract.

A two-stage competitive tender and negotiation process enabled a contract to be awarded in 2012 to install 1.25MWp of solar PV on 30 of the City's buildings and operations at a cost of \$4.3 million over 2 years demonstrating the reduction in solar PV costs in 2 years and the improved economics of procuring large scale solar PV using the City's output performance specification program process.

Solar projects include rooftop as well as glass/glass photovoltaic solar shading systems such as the canopy to Railway Square at Central Station as well as solar photovoltaic roofs on other City buildings such as depots, aquatic centres and other community facilities.

<i>Capacity:</i>	<i>1,245kW-p</i>
<i>Annual Output:</i>	<i>1,953,440kWh pa</i>
<i>Solar panels:</i>	<i>5,230 solar panels</i>
<i>Annual saving:</i>	<i>2,074 tonnes CO_{2-e}</i>

FIGURE 61: PROPOSED GLASS/GLASS/PV SOLAR CANOPY AT RAILWAY SQUARE BUS INTERCHANGE
SOURCE: CITY OF SYDNEY



1 RENEWABLE ENERGY RESOURCES

2 RE-THINKING RENEWABLE ENERGY

3 RENEWABLE ENERGY FOR THE CITY OF SYDNEY

4 PERFORMANCE MEASURES

5 ENABLING THE MASTER PLAN

6 CASE STUDIES

1.

PRECINCT SCALE TECHNOLOGIES

CONCENTRATED SOLAR THERMAL, CSIRO, NEWCASTLE, NEW SOUTH WALES

The Commonwealth Scientific and Industrial Research Organisation (CSIRO) has developed a heliostat technology for commercial scale developments. CSIRO operates two solar fields (Solar Field 1 and Solar Field 2) for research and to demonstrate proof of concept technology.

CSIRO's interest in solar towers was due to their ability to generate very high temperatures inside a fixed-place receiver. The temperature at 800°C can be much higher than solar troughs or linear Fresnel which provides the potential for cheaper electricity generation and also open up new uses for the thermal energy, including distributed electricity and thermal energy generation such as cogeneration or trigeneration or thermal desalination.

Through a further innovation CSIRO has developed a new process to produce SolarGas, a type of syngas that uses concentrated solar energy to convert natural or renewable gas into a product that stores solar energy in chemical form that can be used later or used in the production of many liquid fuels and fine chemicals which currently rely on fossil fuels.

SolarGas is three units of hydrogen gas for every molecule of carbon monoxide and this new gas has more energy than the gas started out with and this additional energy has been derived from the sun.

	Solar Field 1	Solar Field 2
Thermal Peak	550kW	1.2MW
Heliostats	180	451

FIGURE 62: CONCENTRATED SOLAR THERMAL FIELD 1, CSIRO, NEWCASTLE
SOURCE: CSIRO



2.

3.

4.

5.

6.

PRECINCT SCALE TECHNOLOGIES

SOLAR DISTRICT HEATING SYSTEM, MARSTAL, DENMARK

Denmark is a world leader in precinct scale decentralised energy comprising integrated cogeneration, trigeneration, solar and geothermal district heating, together with other forms of solar and wind energy. The number of dwellings in Denmark connected to a decentralised energy/district heating network has grown from 33% in 1981 to more than 60% today, approximately 1.5 million dwellings. Not using electricity for heating and cooling has enabled Denmark to deliver one of the highest amounts of renewable electricity generation, as a proportion of the nation's electricity requirements, in the world.

Marstal is a historic shipbuilding town on the island of Aeroe in the Baltic Sea. Aeroe's energy plan in 1998 is to make the Aeroe Islands (population 7,600) self sufficient in energy and to convert 80–100% of its energy supply to renewable energy. Renewable energy has grown from 40% in 2002 to more than 80% today. Aeroe's three decentralised energy or district heating systems based on solar collectors is supplemented by three 100m high wind turbines and 19 smaller scale wind turbines with a total capacity of 1.48MW supplying 50% of the island's electricity consumption.

The Marstal solar district heating system supplies 1,450 end users and comprises 7 different types of solar collector, mainly flat plate collectors, but also vacuum type, focusing and solar roofs all connected to the decentralised energy or district heating network. The solar system is supported by two different types of thermal stores, gravel water and pit heat storage, with a total thermal storage capacity of 14,000m³. The system is also supported by cogeneration and back up/winter boilers which also supplies Graesvaenge. Plans are in hand to extend the district heating network to Ommel and to make the cogeneration and boilers renewable fuelled using biomass.

<i>Capacity:</i>	<i>12.85MWth</i>
<i>Annual Output:</i>	<i>8,824MWh pa</i>
<i>Solar panels:</i>	<i>18,365m²</i>
<i>Thermal Storage:</i>	<i>14,000m³</i>
<i>Annual saving:</i>	<i>2,500 tonnes CO_{2-e} (replacing oil)</i>

FIGURE 63: SOLAR FIELD SUPPLYING MARSTAL DISTRICT HEATING SYSTEM, DENMARK
SOURCE: DENMARK.DK



1 RENEWABLE ENERGY RESOURCES

2 RE-THINKING RENEWABLE ENERGY

3 RENEWABLE ENERGY FOR THE CITY OF SYDNEY

4 PERFORMANCE MEASURES

5 ENABLING THE MASTER PLAN

6 CASE STUDIES

1.

PRECINCT SCALE TECHNOLOGIES

PARIS GEOTHERMAL DISTRICT HEATING SYSTEM, FRANCE

Geothermal district heating supplies 35% of Europe’s installed thermal energy with a capacity of 5,000MWth. The Paris Basin geothermal district heating system is the second largest system in the world. The Milan geothermal district heating system will be the largest in the world with the completion of the extensions to the existing system. The Paris Basin geothermal district heating system was initiated in the early 1970s and is based on a dependable sedimentary resource utilising the doublet concept of heat extraction. A doublet comprises two wells (production and injection) drilled from a single drilling pad.

Hot water hosted in the permeable carbonate rocks reservoir is extracted at a temperature of 54 to 82°C at varying depths. The geothermal fluid, a hot saline brine, is pumped to the surface from a production well and the heat depleted brine pumped back into the reservoir via an injection well. The 36 geothermal doublets supply 36 district heating networks around the city and serve the equivalent of 250,000 households with thermal energy.

Geothermal district heating forms part of the Paris decentralised energy network with 12 cogeneration/geothermal heating plants with a further 5 sites planned. The natural gas fired cogeneration plants operate as base load and the geothermal heating plants provide the balance of thermal, including top up and back up energy.

<i>Capacity:</i>	<i>235MWth</i>
<i>Annual Output:</i>	<i>1,200GWh pa</i>
<i>Bores:</i>	<i>1.5 to 1.8km doublet depth</i>
<i>Annual saving:</i>	<i>500,000 tonnes CO_{2-e}</i>

FIGURE 64: MEAUX GEOTHERMAL PLANT, PARIS GEOTHERMAL DISTRICT HEATING NETWORK
SOURCE: FRENCH ENVIRONMENT & ENERGY MANAGEMENT AGENCY



2.

3.

4.

5.

6.

PRECINCT SCALE TECHNOLOGIES

MINEWATER GEOTHERMAL DISTRICT HEATING, HEERLEN, NETHERLANDS

Minewater is the water that has to be pumped out to allow mining to take place. In coal mines the volume of water pumped out exceeds that of the coal dug out. Coal minewater is present in very old geological rock strata and contains many salts and heavy metals. The coal mining company must treat the minewater before it is pumped into local rivers or lakes to avoid pollution of the waterways. This is very expensive but is economically worthwhile for the mining company while mining remains a profitable business.

When a coal mine is closed there is no revenue stream from coal sales and the expense of pumping water becomes a burden. However, not pumping and treating the water poses an environmental hazard and may even threaten mining villages. Therefore, minewater must be continuously pumped out of abandoned coal mines.

However, coal mines can provide a form of renewable energy. The loosened rock structure in coal mines leads to an intensive heat exchange between rock and minewater, the deeper the mine, the warmer the water. This geothermal energy can be exploited while the mine is still open as well as after closure. Crucially, a minewater geothermal energy system can provide a focus of sustainable regeneration of former mining areas, demonstrating a new renewable energy resource that can deliver heating and cooling for sustainable communities. This can also improve self-image, health, employment and economy thereby helping to restore local pride.

The Heerlen Minewater project re-engineers an old abandoned coal mine into a source of geothermal energy which takes advantage of flooded underground mine shafts, using their thermal energy to power a district heating system for 350 homes and 161,000m² of commercial, retail, hotel, schools, healthcare and other public building floor space in Heerlerheide precinct, including the Dutch Central Office of Statistics. The geothermal energy is used to provide Heerlerheide with heating and hot water in the winter and cooling in the summer.

The district heating and cooling network derives its geothermal energy from 5 wells drilled in various locations around the town to access the underground mine shafts. Each well is 700m deep and can pump out nearly 80m³ of water per hour. The water temperature at the bottom of the wells is 32°C which gradually cools to 28°C at the surface. The warm water from the mine is brought to the surface where a heat pump extracts and upgrades the heat to district heating flow temperatures. The return temperature minewater is pumped back down to 450m to be reheated in the winter. To provide cooling in the summer, water is pumped from a much shallower depth of 250m, where the water is cooler.

FIGURE 65: MINEWATER GEOTHERMAL DISTRICT HEATING, HEERLEN, NETHERLANDS
SOURCE: INHABITAT.COM



The geothermal district heating is delivered from local sub-energy stations where the heat pumps, cogeneration and back up boilers are also located to generate electricity and to supply thermal energy. The geothermal district heating system reduces primary energy consumption and greenhouse gas emissions by 55%.

<i>Capacity:</i>	<i>2.2MW heating 1MW cooling 2.7MW cogeneration and gas fired back up condensing boilers</i>
<i>Annual Output:</i>	<i>3,399MWh pa electricity 13,885MWh pa heating</i>
<i>Bores:</i>	<i>700m depth</i>
<i>Annual saving:</i>	<i>4,905 tonnes CO_{2-e} (based on Netherlands grid emissions) 6,880 tonnes CO_{2-e} (based on NSW grid emissions)</i>

1 RENEWABLE ENERGY RESOURCES

2 RE-THINKING RENEWABLE ENERGY

3 RENEWABLE ENERGY FOR THE CITY OF SYDNEY

4 PERFORMANCE MEASURES

5 ENABLING THE MASTER PLAN

6 CASE STUDIES

1.

PRECINCT SCALE TECHNOLOGIES

URBAN WIND TURBINES, DAGENHAM, LONDON, UK

In 2006, the London Energy Partnership in conjunction with the Mayor of London undertook an urban wind energy study for Greater London which estimated the installed (non-building integrated) wind energy capacity identified through the study for the Greater London area is predicted to be 50.34MW, generating 144.5GWh of electricity annually, the equivalent of supplying electricity to 116,015 households and reducing greenhouse gas emissions by 147,015 tonnes a year.

The Dagenham urban wind turbines comprise two 1.8MW and one 2.3MW wind turbines directly supplying the Ford Dagenham Diesel Centre with 100% renewable energy. One turbine is located in Ford's surface car park, one turbine on the edge of a soccer pitch and another by the side of a lake. Despite the 79 metre hub height of the turbines and the 82 metre rotor diameters they do not appear to be tall due to the parallax angles and other high infrastructure that is found in a city. Noise is also not an issue, even at night time due to the prevailing noise in a city.

Although wind speeds and capacity factors may be less than in rural areas the Dagenham wind turbines do have the advantage of supplying electricity directly to a consumer on the distribution network, avoiding grid losses and minimising impacts on the electricity infrastructure and therefore, reduced network costs to electricity consumers.

<i>Capacity:</i>	<i>5.9MW</i>
<i>Optimal Wind speeds:</i>	<i>2.5m/s to 28m/s</i>
<i>Annual Output:</i>	<i>11.4GWh pa</i>
<i>Annual saving:</i>	<i>6,725 tonnes CO_{2-e} (based on UK grid emissions)</i> <i>12,085 tonnes CO_{2-e} (based on NSW grid emissions)</i>

FIGURE 66: DAGENHAM WIND TURBINE (1), LONDON, UK
SOURCE: WIKIMEDIA COMMONS



2.

3.

4.

5.

6.

PRECINCT SCALE TECHNOLOGIES

HARBOUR WIND TURBINES, COPENHAGEN, DENMARK

The removal of the regulatory barriers to local energy in Denmark has been so successful that centralised energy power utilities have seen their share of the electricity market reduced to little over 50% of the domestic demand in 10 years.

By 2000, around 150,000 households were co-owners of a local wind turbine. It was the ownership model rather than the tariff structure that led to the success of wind energy in Denmark. It was the key factor behind the high public acceptance that wind energy projects enjoyed and it enabled a much faster deployment, since large numbers of people were involved in the sector that generated tremendous goodwill towards wind energy.

The Middelgrunden wind farm in Copenhagen Harbour became operational in 2000 and comprises twenty 2MW wind turbines with a hub height of 64 metres and a rotor diameter of 76 metres supplying 4% of the electricity requirements of Copenhagen. The offshore wind farm is 3.5km from Copenhagen harbour and highly visible from the 11th century city with its historic and modern buildings.

The Middelgrunden wind farm is 50% owned by the Copenhagen utility and 50% owned by a community cooperative with 8,650 members. Each cooperative share consists of 1,000kWh/year of electricity and was sold for 4,250 DKK (\$710 AUD). The number of shares sold was based on 50% of 81GWh/year with 90% of 89GWh/year guaranteed production providing a rate of return of 7.5% after depreciation. However, annual generation has been as high as 100GWh providing a 5.7% better performance than the guaranteed minimum electricity generation.

<i>Capacity:</i>	<i>40MW</i>
<i>Optimal Wind speeds:</i>	<i>7.2m/s</i>
<i>Annual Output:</i>	<i>91GWh pa</i>
<i>Annual saving:</i>	<i>76,500 tonnes CO_{2-e} (based on Denmark grid emissions)</i> <i>96,460 tonnes CO_{2-e} (based on NSW grid emissions)</i>

FIGURE 67: COPENHAGEN HARBOUR WIND TURBINES, DENMARK
SOURCE: i-SUSTAIN



1 RENEWABLE ENERGY RESOURCES

2 RE-THINKING RENEWABLE ENERGY

3 RENEWABLE ENERGY FOR THE CITY OF SYDNEY

4 PERFORMANCE MEASURES

5 ENABLING THE MASTER PLAN

6 CASE STUDIES

1.

UTILITY SCALE TECHNOLOGIES BEYOND THE CITY

GREENOUGH RIVER SOLAR PV FARM, GERALDTON, WESTERN AUSTRALIA

Greenough River Solar PV Farm is Australia's largest solar farm and is located 50km south east of Geraldton in Western Australia's mid-west region. Phase 1 of the project comprises 150,000 thin film photovoltaic modules with a capacity of 10MWp and was opened in October 2012. This project is the first phase of the full planned capacity of 40MWp.

The thin film photovoltaic modules mounted on 16,000 steel posts and brackets use the stable compound cadmium telluride (CdTe) as the semiconductor which delivers high energy yields. CdTe is less susceptible to cell temperatures than traditional semiconductors and CdTe also converts low and diffuse light into electricity more efficiently than conventional cells. Together, this means that thin film photovoltaic modules produce more electricity on hot days, under cloudy weather and across a larger percentage of normal daylight.

The solar farm's output is purchased by Western Australia Water Corporation to help offset the electricity requirements of its Southern Seawater Desalination Plant near Binningup which will produce 50 gigalitres of potable water a year.

<i>Capacity:</i>	<i>10MWp</i>
<i>Annual Output:</i>	<i>22GWh pa</i>
<i>Solar panels:</i>	<i>150,000 solar panels</i>
<i>Land Area:</i>	<i>80 hectares</i>
<i>Annual saving:</i>	<i>20,000 tonnes CO_{2-e} (based on WA grid emissions)</i> <i>21,560 tonnes CO_{2-e} (based on NSW grid emissions)</i>

FIGURE 68: GREENOUGH RIVER SOLAR PV FARM, WESTERN AUSTRALIA
SOURCE: GREENOUGH RIVER SOLAR FARM



2.

3.

4.

5.

6.

UTILITY SCALE TECHNOLOGIES BEYOND THE CITY

CONCENTRATED SOLAR THERMAL POWER, SEGS, MOJAVE DESERT, CALIFORNIA, USA

The Solar Energy Generating Systems (SEGS) parabolic trough concentrated solar thermal power system is the largest concentrated solar thermal power system in the world. It consists of 9 solar power plants in California's Mojave Desert, where insolation is amongst the best available in the United States. The first solar plant became operational in 1985 and the last solar plant became operational in 2002.

The sun bounces off the glass parabolic mirrors, which are 94% reflective, and is directed to a central tube filled with synthetic oil, which heats to over 400°C. The reflected light focused at the central tube is 70 to 80 times more intense than ordinary sunlight. The synthetic oil transfers heat to water, which boils and drives the Rankine cycle steam turbines, thereby generating electricity.

The SEGS plants have a 354MWe installed capacity but the average gross solar output for all nine plants is 75MWe – a capacity factor of 21%. About 90% of the electricity is produced by solar energy and 10% by natural gas which is only used when solar power is insufficient to meet contracted demand from Southern California's electricity distribution network services provider.

<i>Capacity:</i>	<i>354MWe</i>
<i>Annual Output:</i>	<i>662GWh pa</i>
<i>Solar panels:</i>	<i>936,384 solar parabolic mirrors</i>
<i>Land Area:</i>	<i>647.5 hectares</i>
<i>Annual saving:</i>	<i>436,258 tonnes CO_{2-e} (based on California grid emissions)</i> <i>648,760 tonnes CO_{2-e} (based on NSW grid emissions)</i>

FIGURE 69: CONCENTRATED SOLAR THERMAL POWER, SEGS, MOJAVE DESERT, CALIFORNIA, USA
SOURCE: RENEWABLE ENERGY



1 RENEWABLE ENERGY RESOURCES

2 RE-THINKING RENEWABLE ENERGY

3 RENEWABLE ENERGY FOR THE CITY OF SYDNEY

4 PERFORMANCE MEASURES

5 ENABLING THE MASTER PLAN

6 CASE STUDIES

1.

UTILITY SCALE TECHNOLOGIES BEYOND THE CITY

GEMASOLAR CONCENTRATED SOLAR THERMAL POWER, FUENTES DE ANDALUCIA, SEVILLA, SPAIN

The Gemasolar concentrated solar thermal power plant near Fuentes de Andalucia, Spain is the first commercial solar plant with central tower receiver and molten salt heat storage technology. It consists of a 140 metre high solar power tower using molten salt as its heat transfer fluid and energy storage medium. The plant became operational in 2011.

The heliostats (flat mirrors) reflect solar radiation onto a receiver located at the top of the tower through which molten nitrate salts flow. The salts are impelled from a cold tank to the receiver located at the top of the tower where they are heated to 565°C but can climb to 900°C. The hot salts then descend to the heat exchanger and generate steam to run a turbine. Any surplus energy, where the heat radiation received is more than required by the turbine, is stored in the form of salts in a hot tank to be used later when solar radiation is low. The salts transfer the stored thermal energy and continue to generate electricity.

The Gemasolar plant molten salt storage tank permits independent electricity generation for up to 15 hours without any solar resource as the turbine can be operated at normal capacity when there is a loss of or a reduction in solar radiation due to clouds or overnight. This increases electricity production for up to 6,500 hours a year – a capacity factor of 74%.

<i>Capacity:</i>	<i>19.9MWe</i>
<i>Annual Output:</i>	<i>110GWh pa</i>
<i>Solar panels:</i>	<i>2,650 heliostats</i>
<i>Land Area:</i>	<i>195 hectares</i>
<i>Annual saving:</i>	<i>51,150 tonnes CO_{2-e} (based on Spain grid emissions)</i> <i>107,800 tonnes CO_{2-e} (based on NSW grid emissions)</i>

FIGURE 70: GEMASOLAR CONCENTRATED SOLAR THERMAL POWER, FUENTES DE ANDALUCIA, SEVILLA, SPAIN
SOURCE: TORRESOL ENERGY



2.

3.

4.

5.

6.

UTILITY SCALE TECHNOLOGIES BEYOND THE CITY

CAPITAL ONSHORE WIND FARM, BUNGENDORE, NEW SOUTH WALES

Onshore wind energy is a relatively mature renewable energy technology in New South Wales contributing 652GWh to NSW electricity generation. NSW has around 2,000MW of new wind generation proposals with development consent and an additional 6,700MW under assessment through the planning system.

The Capital wind farm, commissioned in 2009, is located near Bungendore in New South Wales nearby to Canberra and is spread across the Hammonds, Ellendon and Groses Hill ridgelines. While the wind farm covers more than 3,500 hectares, the turbines themselves occupy less than one hectare of land. The wind farm is located in open farming country, allowing for optimum spacing of turbines, and achieves a capacity factor of 36%.

The wind farm comprises sixty-seven 2.1MW wind turbines with a hub height of 80 metres and a rotor diameter of 88 metres. The start-up wind speed is 4m/s and maximum power is reached at 11m/s. Cut-off wind speed is 25m/s.

The electricity is fed directly into the transmission grid at 330kV but is sold to the Sydney desalination plant at Kurnell on a 20 year power purchase agreement to offset the desalination plant's grid greenhouse gas emissions. The Capital wind farm generates 443GWh a year but the Sydney desalination plant consumes between 225GWh and 900GWh a year depending on its operational cycle and how much desalinated water is required in times of drought.

<i>Capacity:</i>	<i>140.7MW</i>
<i>Optimal Wind speeds:</i>	<i>4m/s to 25m/s</i>
<i>Land Area:</i>	<i>3,500 hectares (1 hectare occupied)</i>
<i>Annual Output:</i>	<i>443GWh pa</i>
<i>Annual saving:</i>	<i>400,000 tonnes CO_{2-e}</i>

FIGURE 71: CAPITAL ONSHORE WIND FARM, BUNGENDORE, NEW SOUTH WALES
SOURCE: INFIGEN



1 RENEWABLE ENERGY RESOURCES

2 RE-THINKING RENEWABLE ENERGY

3 RENEWABLE ENERGY FOR THE CITY OF SYDNEY

4 PERFORMANCE MEASURES

5 ENABLING THE MASTER PLAN

6 CASE STUDIES

1.

UTILITY SCALE TECHNOLOGIES BEYOND THE CITY

LONDON ARRAY OFFSHORE WIND FARM, THAMES ESTUARY, UK

Although currently more costly than onshore wind turbines offshore wind is one of the most powerful sources of renewable energy and offshore wind turbines have the advantage of avoiding the noise and visual impacts of onshore wind turbines in rural environments. Offshore wind farms also have access to greater wind resources with higher capacity factors than onshore wind farms.

Europe's offshore wind potential is enormous and able to meet 7 times Europe's electricity demand with 4.3GW currently installed with growth potential of 150GW by 2030. This would increase the number of jobs from 35,000 to 300,000 by 2030. The UK has one of the highest offshore wind energy resources in the world, with over 33% of the total European potential – enough to power the UK three times over.

The UK's offshore grid also enables other marine renewable energy devices, such as wave and tidal, to be connected to the UK's grid.

The London Array wind farm is located near London approximately 20km offshore from Essex and Kent in the Thames Estuary/Southern North Sea. Phase 1 of the wind farm, comprising 630MW, was commissioned in 2012 and Phase 2 will increase the total capacity to 870MW which will make it the world's largest offshore wind farm. With Phase 2 the project will reduce greenhouse gas emissions by 1.4 million tonnes a year.

Phase 1 comprises one hundred and seventy-five 3.6MW wind turbines with a hub height of 87 metres and a rotor diameter of 120 metres, ie, a total turbine height of 147 metres. The start-up wind speed is 4m/s and maximum power is reached at 13m/s. Cut-off wind speed is 25m/s, equivalent to a Force 9 gale. The turbines are designed to run for over 20 years, 24 hours a day, 7 days a week.

Each wind turbine plus two sub-stations are placed on foundations consisting of monopiles measuring up to 68 metres tall and 5.7 metres wide, and weigh up to 650 tonnes. Hydraulic hammers were used to hammer each monopile into the sea bed, using a 'soft start' process, so that fish and marine mammals can move away from the noise before it reaches full power.

A new operations base for London Array was built in Ramsgate, Kent creating up to 90 permanent jobs in the local area. Over 90 Kent based companies are already involved in the project.

FIGURE 72: LONDON ARRAY OFFSHORE WIND FARM, THAMES ESTUARY, UK
SOURCE: LONDON ARRAY

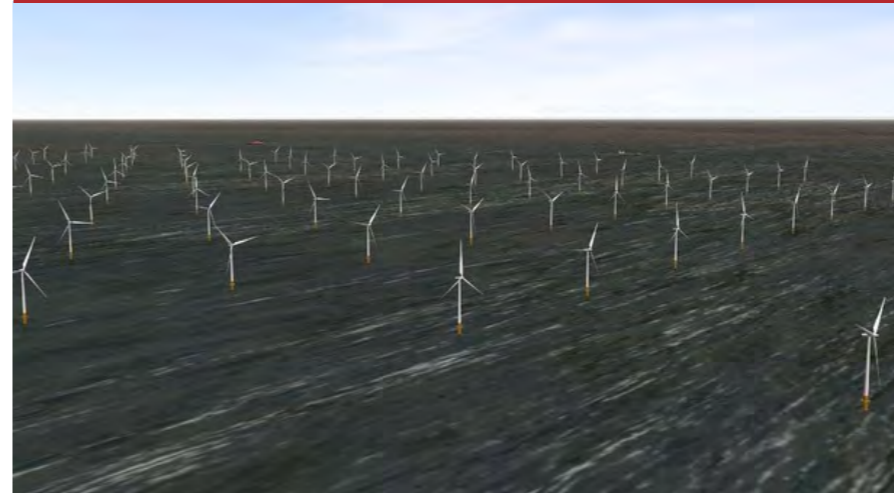

<i>Capacity (Phase 1):</i>	630MW
<i>Optimal Wind speeds:</i>	4m/s to 25m/s
<i>Sea Area:</i>	24,500 hectares (7 hectares occupied)
<i>Annual Output:</i>	1,576GWh pa
<i>Annual saving:</i>	925,000 tonnes CO _{2-e} (based on UK grid emissions) 1,544,480 tonnes CO _{2-e} (based on NSW grid emissions)

2.

3.

4.

5.

6.

UTILITY SCALE TECHNOLOGIES BEYOND THE CITY

PERTH WAVE ENERGY PROJECT, WESTERN AUSTRALIA

Ocean energy is a so far untapped source of renewable energy. Of the various ways to harvest energy from the ocean the largest potential is found in the waves. The global resource according to the International Energy Agency is somewhere between 8,000 – 80,000TWh/year. Australia has considerable wave energy resources in reasonable proximity to cities and potential industry users. For example, wave energy capacity from Geraldton to Tasmania alone is over 1,300TWh/year, about five times Australia's total energy requirements.

Wave energy technologies currently being developed in Australia include Carnegie Wave Energy CETO, Ocean Power Technologies PowerBuoy, Oceanlinx greenWAVE and blueWAVE, BioPower Systems BioWAVE, Advanced Wave Power Nautilus, AquaGen Technologies SurgeDrive, Proteus Wave Power wave energy harvester, Wave Rider Energy wave energy harvester and PerpetuWave Power wave energy harvester.

The Carnegie shallow water wave energy technology is based on arrays of submerged buoys which are tethered to seabed pump units. The pumps are driven by the buoys as they oscillate under the influence of passing waves. The resulting pressurised water is pumped onshore via a pipeline to drive hydro-electric turbines, which generate electricity, or used to pressurise seawater for reverse osmosis desalination plants to produce potable water. Carnegie is developing its CETO technology in Australia, Eire and Reunion.

Carnegie Wave Energy proved the concept of generating electricity from ocean waves with its CETO 1 wave technology prototype in 2006 and by 2008 had developed and tested CETO 2 prototypes in the waters of Fremantle, Western Australia. Between 2009 and 2011 CETO 3, a commercial scale unit, was developed and tested in the waters off Garden Island, home to HMAS Stirling, Australia's largest naval base. The CETO 3 buoy had a 7 metre diameter with a peak capacity of 200kW tethered to the seabed pump so that the buoy was 2m below sea level. With transmission and energy conversion this de-rates to 160kW to which a capacity factor of 20–40% is applied.

In 2012, Carnegie Wave Energy signed a power supply and grid connection agreement with the Australian Department of Defence to supply electricity exclusively to the HMAS Stirling naval base. The \$31 million demonstration project is supported by a \$10 million grant from the Australian Government and a \$5.5 million grant from the Western Australian Government.

The Perth Wave Energy Project will consist of five submerged CETO 5 units with 11 metre diameter buoys with increased peak capacity in an array within 250m by 300m offshore lease area located 3km South West of Garden Island. The CETO 5 units will be installed in water depths of 25m, with wave energy harnessed by the CETO units transferred via freshwater based fluid within two heavy 3.2km heavy steel pipelines from the offshore units to the onshore power station. It is anticipated that electricity will be supplied from the project to HMAS Stirling naval base by the end of 2013.

FIGURE 73: CETO 3 WAVE ENERGY UNIT, GARDEN ISLAND, WESTERN AUSTRALIA

SOURCE: CARNEGIE WAVE ENERGY



Capacity:	2MWp
Annual Output:	3.85GWh pa (projected)
Wave buoys:	5 CETO units
Sea Area:	7.5 hectares
Annual saving:	3,500 tonnes CO _{2-e} (projected – based on WA grid emissions) 3,775 CO _{2-e} (projected – based on NSW grid emissions)

1 RENEWABLE ENERGY RESOURCES

2 RE-THINKING RENEWABLE ENERGY

3 RENEWABLE ENERGY FOR THE CITY OF SYDNEY

4 PERFORMANCE MEASURES

5 ENABLING THE MASTER PLAN

6 CASE STUDIES

1.

UTILITY SCALE TECHNOLOGIES BEYOND THE CITY

PORTLAND POWERBUOY WAVE ENERGY PROJECT, VICTORIA

The Ocean Power Technologies (OPT) PowerBuoy deep water wave energy technology is based on the rise and fall of passing waves causing a surface floating buoy, tethered to the seabed, to move up and down. The oscillating action is converted to electricity via a mechanical generator and transmitted to on shore by submarine cable. The PowerBuoy and its moorings have an operational range of 1.2 to 7 metres and are certified to survive a 100-year, 24 metre wave.

USA-based Ocean Power Technologies was founded by Australian inventor George Taylor in 1994 and began ocean trials off New Jersey in 1997. Three projects have so far been completed off Atlantic City, New Jersey in 2005 (40kW), Hawaii in 2009 (40kW) and Scotland in 2011 (150kW). Other projects are currently being developed off Coos Bay (100MW) and Reedsport (1.5MW), Oregon; Santana (1.39MW), Spain; Cornwall (5MW), UK and Portland (19MW), Victoria, Australia.

In 2010, Victorian Wave Partners, a joint venture between Ocean Power Technologies and Leighton Contracting formed in 2008 to develop wave power opportunities off the South and East coasts of Australia, received a \$66.7 million grant from the Australian Government to construct a 19MW wave power project off the coast of Victoria, near Portland. In 2012, Ocean Power Technologies brought in US defence contracting giant Lockheed Martin in a 'teaming agreement' as the major contractor on the \$230 million project.

Phase 1 of the Portland PowerBuoy wave energy project will employ the 150kW PowerBuoys and Phases 2 and 3 will employ the next generation 500kW PowerBuoys connected to 5 submarine substation pods and submarine cable to an onshore substation connected to the grid. Construction is expected to commence in 2013 with the first phase delivering electricity to the grid in 2014.

<i>Capacity:</i>	<i>19MW</i>
<i>Annual Output:</i>	<i>75GWh pa (projected)</i>
<i>Wave buoys:</i>	<i>45 PowerBuoys</i>
<i>Sea Area:</i>	<i>23 hectares</i>
<i>Annual saving:</i>	<i>37,000 tonnes CO_{2-e} (projected – based on VIC grid emissions)</i>
	<i>27,360 CO_{2-e} (projected – based on NSW grid emissions)</i>

FIGURE 74: 150KW POWERBUOY, SCOTLAND, UK
SOURCE: OCEAN POWER TECHNOLOGIES



2.

3.

4.

5.

6.

UTILITY SCALE TECHNOLOGIES BEYOND THE CITY

LA RANCE BARRAGE TIDAL POWER, FRANCE

Barrage tidal power makes use of the energy in the difference in height or head between high and low tides. A barrage is similar to a hydro-electric dam but spans an estuary basin, bay or river with gates or sluices that enables the tide to move in and out of the dammed area. At high tide, the sluices are closed but once the tide shifts direction and ebbs, the sluices are opened allowing the higher water levels in the basin to flow through the barrage and the hydro-electric turbines on its way out to sea. Electricity generation is approximately 10 hours a day and predictable.

Barrage tidal power is a popular form of renewable energy normally combined with other measures such as climate change adaptation, flood prevention, transport crossings, etc. Barrage tidal power projects have been installed in Canada, China, Russia, France, South Korea and the UK with the largest project at the Sihwa Lake Tidal Power Station, South Korea at 254MW. The 1,320MW Incheon barrage tidal project is currently under construction which will be completed in 2015. A further 110,000MW of barrage tidal power projects are proposed around the world, the largest of which is the 8,640MW Severn Barrage project in the UK which could supply up to 5% of the UK's electricity demand with a carbon payback of less than 6 months. The 120 years operational lifetime of the project is also four times that of a nuclear power station.

Built in 1966, La Rance barrage tidal power station is the world's first tidal power station and also the world's second largest tidal power station. The barrage is located on the estuary of La Rance River in Brittany, France and is 750 metres long, from Brebis point in the West to Briantais point in the East. The power plant portion of the dam is 332.5 metres long. With a peak capacity of 240MW the tidal barrage supplies 0.012% of the electricity demand of France. The capacity factor of the tidal barrage is 26%, generating 62MW on average.

A canal lock in the West end of the dam permits the passage of 20,000 vessels a year (maximum 16,000 tonnes) between the English Channel and La Rance. Highway 168 crosses the dam and allows vehicles to travel between Dinard and Saint-Malo (26,000 vehicles a day). There is a drawbridge where the road crosses the lock which may be raised to allow larger vessels to pass.

In terms of environmental impact, the tidal barrage has caused progressive silting of the La Rance ecosystem. Sand-eels and plaice have disappeared, though sea bass and cuttlefish have returned to the river. Tidal flow levels in the estuary are adjusted by the tidal barrage operator to minimise the biological impact. In terms of tourism, the tidal barrage attracts 70,000 visitors a year.

FIGURE 75: LA RANCE BARRAGE TIDAL POWER, FRANCE
SOURCE: ALLIANZ KNOWLEDGE

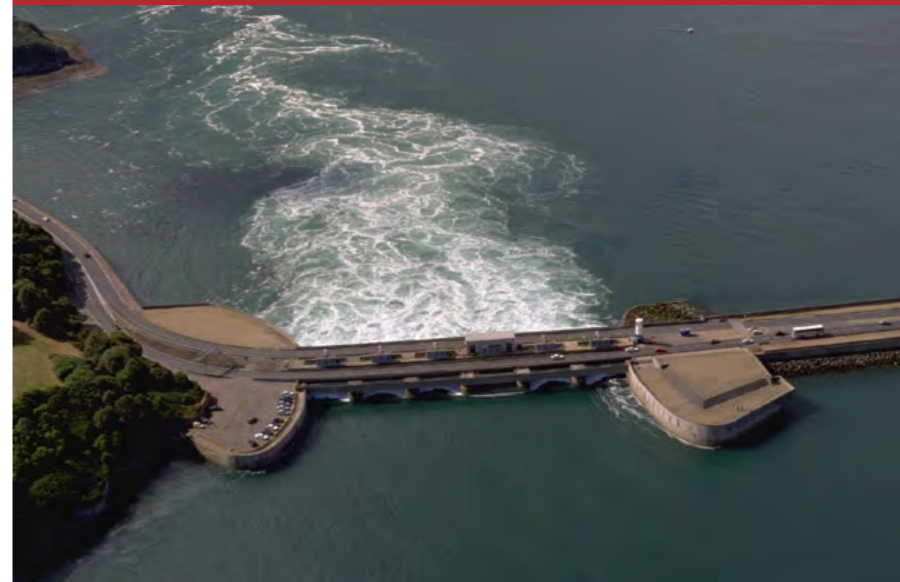

<i>Capacity:</i>	<i>240MWp</i>
<i>Annual Output:</i>	<i>540GWh pa</i>
<i>Generation:</i>	<i>24 turbines</i>
<i>Basin Area:</i>	<i>2,250 hectares tidal basin</i>
<i>Annual saving:</i>	<i>48,600 tonnes CO_{2-e} (based on France grid emissions) 529,200 CO_{2-e} (based on NSW grid emissions)</i>

1 RENEWABLE ENERGY RESOURCES

2 RE-THINKING RENEWABLE ENERGY

3 RENEWABLE ENERGY FOR THE CITY OF SYDNEY

4 PERFORMANCE MEASURES

5 ENABLING THE MASTER PLAN

6 CASE STUDIES

1.

UTILITY SCALE TECHNOLOGIES BEYOND THE CITY

STRANGFORD NARROWS TIDAL POWER, NORTHERN IRELAND

Tidal energy is a consistent and relatively accessible resource with the potential to provide about 0.5% of Australia's electricity. The potential for non-tidal or ocean current energy is large at 44TWh/year or 20% of Australia's electricity requirements or nearly 60% of NSW electricity requirements. Similar technologies are used for both forms of renewable energy.

Tidal stream generators make use of the kinetic energy of moving water or tides to power turbines and generate electricity in a similar way to wind turbines. However, the potential for electricity generation by an individual tidal turbine can be far greater than that of a similarly rated wind energy turbine. The density of water is 832 times the density of air which means that a single tidal generator can provide significant power at low tidal flow velocities compared with a similar wind speed. At higher speeds in a flow of between 2 and 3 metres per second in seawater a tidal turbine can typically, access four times as much energy per rotor swept area as a similarly rated power wind turbine.

Tidal stream generators can be axial, vertical and horizontal crossflow and flow augmented turbines or oscillating or Venturi effect devices. Some tidal generators can be built into the structures of existing bridges with virtually no aesthetic issues.

UK-based Marine Current Turbines was established in 1999 and installed the 300kW Seaflow, the world's first offshore tidal turbine near Lynmouth, Devon, UK in 2003. This was followed by the completion of the 1.2MW SeaGen offshore tidal turbine in 2008. Other projects being developed include tidal array projects off Kyle Rhea, Scotland (8MW), Anglesey Skerries, Wales (10MW) and Brough Ness. Marine Current Turbines also has an agreement in place to supply a SeaGen device for the Minas Pulp & Power site at Force in the Bay of Fundy, Canada.

Siemens acquired the complete shareholding of Marine Current Turbines in 2012 with the intention of becoming the leading OEM in the emerging world tidal energy market. Marine Current Turbines is now operated as a Siemens business under the Siemens Solar & Hydro Division. Siemens products are already installed in several offshore wind farms and Siemens is currently involved in constructing a number of further projects as well as targeting other offshore renewables including tidal stream.

The Strangford Narrows tidal power system consists of a SeaGen twin rotor tidal stream turbine with a capacity factor of 83%. The turbine generates between 18 and 20 hours a day when the tides are forced in and out of Strangford Lough through the Narrows. The 1,000 tonne structure with 16 metre rotor blades is located 400 metres from the shoreline. The quadropod section that sits on

FIGURE 76: STRANGFORD NARROWS TIDAL POWER, NORTHERN IRELAND

SOURCE: MARINE CURRENT TURBINES



the seabed was pin piled to a depth of 9 metres and took 14 days to install. The support infrastructure also enables the turbines to be raised out of the water for ease of maintenance.

The SeaGen system has the largest swept area of all the commercial scale tidal products currently available. The turbines have a patented feature by which the rotor blades can be pitched through 180 degrees, allowing them to optimise energy capture and operate in bi-directional flows. The rotors are positioned in the top third of the water column where tidal currents are strongest, therefore maximising the energy capture. These design features allow the SeaGen system at Strangford Lough to achieve more than 48% efficiency over a broad range of current velocities.

Tidal stream generators are unlikely to have any significant effect on natural processes as energy capture from a tidal stream is kept below 10–15% of the flow velocities. Impact on marine wildlife is also low as the speed of the underwater turbines is low compared to ship or boat propellers. A tidal turbine rotor at a good site absorbs about 4kW/m² of swept area from the current, whereas typical ship propellers release over 100kW/m² of swept area into the water column.

<i>Capacity:</i>	<i>1.2MW</i>
<i>Annual Output:</i>	<i>8.76GWh pa</i>
<i>Generation:</i>	<i>1 tidal stream turbine</i>
<i>Tidal Current:</i>	<i>> 2.4m/s at rated power</i>
<i>Annual saving:</i>	<i>5,140 tonnes CO_{2-e} (based on UK grid emissions) 8,585 CO_{2-e} (based on NSW grid emissions)</i>

2.

3.

4.

5.

6.

UTILITY SCALE TECHNOLOGIES BEYOND THE CITY

AVEDORE 2 RENEWABLE HYBRID CITY-WIDE COGENERATION NETWORK, COPENHAGEN, DENMARK

Hybridisation of renewables with fossil fuelled generation can address the intermittency of renewable electricity such as solar or wind power but it can also provide a continuous greater scale non-intermittent hybrid renewable energy system with biomass and provide a pathway to a 100% renewable energy future by replacing fossil fuels with renewable fuels and gases over time.

Denmark is a world leader in precinct scale decentralised energy comprising integrated cogeneration, trigeneration, solar and geothermal district heating, together with other forms of solar and wind energy. The number of dwellings in Denmark connected to a decentralised energy/district heating network has grown from 33% in 1981 to more than 60% today, approximately 1.5 million dwellings. Not using electricity for heating and cooling has enabled Denmark to deliver one of the highest amounts of renewable electricity generation, as a proportion of the nation's electricity requirements, in the world.

The district heating network in Greater Copenhagen began in the 1920s and today the 1,500km double-piped thermal reticulation network extending 40km across metropolitan Copenhagen now supplies more than 98% of the thermal energy demand in the City of Copenhagen, some 30,000 customers and 500,000 residents. The City of Copenhagen owns 70% of the Greater Copenhagen district heating network with the remaining 30% owned by surrounding municipalities or councils.

The City of Copenhagen ownership of the district heating network is via 100% owned not-for-profit Copenhagen Energy Ltd who operate the network. Operation and maintenance is sub contracted to two private companies. Energy centres and energy outputs are owned by energy companies such as Dong Energy who own and operate the Avedore 1 and 2 cogeneration energy centres.

The district heating network is served by 10 combined heat and power or cogeneration plants generating 1,652MW of electricity and 2,047MW of heat. District cooling has also been developed from the thermal energy system providing trigeneration in parts of the city which is a growing demand due to the warming climate.

The district heating network has been supplemented by large scale solar thermal and geothermal energy injecting renewable heat into the district heating network. Biomass, renewable gases and waste to energy also supplies the Greater Copenhagen district energy network which is now fuelled by 33% renewable energy sources. Copenhagen has set a target to become the first carbon neutral capital city by 2025 by increasing energy efficiency and renewable energy. A key component of this is to replace all fossil fuels supplying the district energy network with renewable fuels and gases by 2025.

FIGURE 77: AVEDORE 1 & 2 RENEWABLE HYBRID CITY-WIDE COGENERATION NETWORK, COPENHAGEN, DENMARK

SOURCE: CITY OF COPENHAGEN



The 810MWe multi-fuel Avedore cogeneration plant is one of the cogeneration plants supplying the Greater Copenhagen decentralised or district energy networks. Avedore 1 was commissioned in 1990 and Avedore 2 replaced three coal fired power stations in 2001 reducing greenhouse emissions by 30% and Denmark's greenhouse gas emissions by 10%. Avedore 2 supplies heat to 200,000 of the 500,000 households supplied from the Greater Copenhagen district thermal energy network and electricity to 1.3 million households. Avedore 1 uses a mixture of coal and oil and Avedore 2 co-fires natural gas, oil and wood pellets and combusts straw in a separate boiler.

The Avedore 2 main plant consists of an 80 metre high co-fired (gas/oil/wood) main boiler that is connected to a 30 metre long turbine with associated 13 metres long generator. This is supplemented by a 45MW biomass (straw) boiler and two 110MWe gas turbines. The exhaust gases from the gas turbines are used for auxiliary heating of water in the plant's main boiler, which contributes to a record-high electrical efficiency of 49% and overall efficiency of 94%. Avedore 2 has some of the world's most advanced plants for flue gas cleaning and reclamation of mineral products such as ash and gypsum which is used in the concrete and building industries and ash from the straw is returned to the fields as fertiliser.

<i>Capacity:</i>	<i>585MW electricity / 570MW heat</i>
<i>Annual Output:</i>	<i>4,832GWh pa electricity / 4,708GWh pa heating</i>
<i>Thermal Storage:</i>	<i>44,000m³</i>
<i>Annual saving:</i>	<i>406,006 tonnes CO_{2-e} (based on Denmark grid emissions) 832,400 tonnes CO_{2-e} (based on NSW grid emissions)</i>

1 RENEWABLE ENERGY RESOURCES

2 RE-THINKING RENEWABLE ENERGY

3 RENEWABLE ENERGY FOR THE CITY OF SYDNEY

4 PERFORMANCE MEASURES

5 ENABLING THE MASTER PLAN

6 CASE STUDIES

1.

RENEWABLE GASES

MEADOW BRANCH LANDFILL RENEWABLE GAS GRID INJECTION, ATHENS, TENNESSEE, USA

Americans generate about 250 million tons (227 million tonnes) of waste a year, of which 65 million tonnes of municipal solid waste (MSW) is recycled. In 1986, there were 7,683 landfills in the United States. By 2009, there were just 1,908 landfills nationwide, a 75% reduction in the number of landfills in 25 years. However, decline in the number of landfills is deceptive. Much of the decrease is due to consolidation of multiple landfills into a single, more efficient facility. Also, technology has allowed each acre (0.4 hectares) of landfill to take 30% more waste. So during this time, the available landfill per person has increased by almost 30%.

Landfills are the third largest source of human-related methane emissions in the United States. Methane can be captured from landfills and used to produce biogas. The biogas can be upgraded into a substitute natural gas and injected into the gas grid.

The Meadow Branch landfill began receiving MSW in 1997, and currently receives around 1,400 tons (1,270 tonnes) a day of waste, 5½ days a week, and achieves 65% compaction. The waste composition is approximately 85% MSW, 10% sewage sludge, 2% construction and demolition waste and 3% industrial waste. The permitted footprint of landfill has approximately 15 acres (6 hectares) remaining. At the current decomposition rate, the permitted landfill has approximately 9 years of useful life, although landfill gas emissions would continue long after this time.

Landfill gas is principally methane which has a Global Warming Potential of 21. In other words, methane is 21 times more powerful than carbon dioxide as a greenhouse gas so methane captured and converted into a renewable gas will reduce greenhouse gas emissions by 21 times than the fossil fuel natural gas carbon dioxide that it replaces in the gas grid.

In 2011, Renewco, a joint venture between AGL Resources and Keystone Renewable Energy, completed a new methane recovery facility at Meadow Branch landfill which captures the landfill gas produced by the decomposition of solid waste in the landfill, converts it into pipeline quality renewable gas (substitute natural gas) and injects the gas into the gas grid. AGL Resources is an Atlanta-based energy services company serving approximately 2.3 million customers in six states. The renewable gas output from the Meadow Branch facility is contracted to a single customer via a 10 year gas purchase agreement.

Tennessee, as a coal state generates more than 50% of its electricity supply from coal fired power generation. In common with other coal states Tennessee has low wholesale electricity prices but high electricity retail prices primarily driven by high electricity grid network charges transporting electricity from remote power stations to cities.

The low wholesale electricity prices make generating electricity from landfill gas and exporting to the electricity grid uneconomic. However, up to four times the primary renewable gas resource is captured with renewable gas generation compared to renewable electricity generation, wholesale gas prices are higher, gas grid network charges lower and gas tariffs do not suffer from the time of day pricing and charging that electricity tariffs suffer from. These factors combined make renewable gas grid injection an attractive economic proposition.

The project began with a thorough analysis of the landfill characteristics to determine the viability of the project. Once the project was determined to be suitable, 70 gas wells and a gas collection system were installed on the landfill site.

Landfill gas is around 50–55% methane and 40–45% carbon dioxide CO₂, with traces of other constituents such as non-methane organics and hydrogen sulphide. Typically, gas grids require gas to be approximately 97% methane.

The processing plant was also constructed on the landfill site to produce renewable gas that meets the same specification as pipeline quality natural gas. The process involves removing water and moisture from the gas, then using a combination of pressure swing absorption – a technology used to separate the different gases from a mixture of gases under pressure – and membrane separation filter – the use of thin barriers to mechanically separate the renewable gas from the other unusable gases.

2.

3.

4.

5.

6.

RENEWABLE GASES

The membrane separation filter comprises tubes that the gas passes through, and the very tiny pores in the membrane allow carbon dioxide CO₂ to leave and the methane to continue through. Once the gas is 97–98% methane the gas is transferred to a booster compressor which raises the gas to the pressure required for injection into the gas grid.

Unusable gases are destroyed in a high temperature thermal oxidiser.

The final step is transferring the renewable gas for transportation to a connection point with an interstate pipeline system. At the Meadow Branch facility, 9 miles (14.5km) of 4 inch (100mm) steel pipe were constructed to connect the renewable gas to Spectra Energy's East Tennessee gas grid pipeline near Riceville, Tennessee.

The Meadow Branch facility processes and transports approximately 1,200 million BTU (1,266GJ) of gas a day, which is expected to grow to 3,000 million BTU (3,165GJ) of gas a day over the 20-year life of the project.

FIGURE 78: MEADOW BRANCH LANDFILL RENEWABLE GAS GRID INJECTION, ATHENS, TENNESSEE, USA
SOURCE: RENEWCO



Feedstock: 440,000t/yr of principally MSW
Gas Grid Injection Capacity: 1,415m³/hour
Annual Gas Grid Injection: 130GWh (468,000GJ)
Annual saving: 644,280 tonnes CO_{2-e}

1 RENEWABLE ENERGY RESOURCES

2 RE-THINKING RENEWABLE ENERGY

3 RENEWABLE ENERGY FOR THE CITY OF SYDNEY

4 PERFORMANCE MEASURES

5 ENABLING THE MASTER PLAN

6 CASE STUDIES

1.

RENEWABLE GASES

DIDCOT SEWAGE TREATMENT PLANT RENEWABLE GAS GRID INJECTION, OXFORDSHIRE, UK

Sewage or urban wastewater is a mixture of domestic wastewater from kitchens, bathrooms and toilets, the wastewater from industries discharging to sewers and rainwater run-off from roads and other impermeable surfaces such as roofs, pavements and roads draining to sewers.

Although untreated wastewater is mainly water, without treatment the wastewater produced every day would cause significant damage to the environment and pose potential health risks. Effective treatment also means treated wastewater can be returned to the environment to maintain river flows for conservation, fisheries and recreational interests. The other by-product of sewage treatment is sewage sludge, which needs to be appropriately re-utilised or disposed of.

Every day in the UK over 624,200km of sewers collect more than 11 billion litres of wastewater from homes, municipal, commercial and industrial premises and rainwater run-off from roads and other impermeable surfaces. The UK's sewage undertakers are responsible for building, maintaining and improving main sewers, pumping stations and wastewater treatment facilities that service around 96% of the UK population.

The UK produces 1.73 million tonnes of sewage sludge a year that could be used to generate renewable gas. The largest collection systems in the UK are linked to around 9,600 wastewater or sewage treatment plants. Of these, 146 sewage sludge treatment plants generate energy amounting to 110MWe of generation.

Prior to 2011, renewable gas production in the form of landfill gas and sewage gas generated 1.4 billion cubic metres (53.5PJ) of renewable gas representing a significant proportion of the UK's renewable energy portfolio. However, because of the commercial incentives driven by the Renewable Energy Obligation, all of this gas was used to generate electricity at efficiency levels of around 30%, or less. If this gas was injected into the gas grid efficiency levels would increase to more than 90%, generating three times the amount of renewable energy from the same primary renewable resource than renewable electricity generation.

The National Grid estimates that renewable gas injected into the gas grid instead of exporting to the electricity grid, could supply 18 billion cubic metres (688PJ) of renewable gas a year, representing 50% of residential gas demand.

Since 2011, there has been a drive to inject renewable gas into the gas grid assisted by the knowledge of the efficiency gains and the introduction of the Renewable Heat Incentive, which also includes renewable gas grid injection supplying cogeneration, trigeneration or heating. There are now 54 farm waste renewable gas generation sites and the first sewage treatment plant injecting renewable gas into the gas grid by Thames Water at one of their plants in Didcot, Oxfordshire.

FIGURE 79: DIDCOT SEWAGE TREATMENT PLANT RENEWABLE GAS GRID INJECTION, OXFORDSHIRE, UK
SOURCE: CNG SERVICES



Thames Water is the UK's largest water and wastewater services company, supplying 2.5GL of drinking water a day to 9 million customers using 102 water treatment plants and treating 4GL of wastewater a day from 14 million customers using 2,530 sewage treatment plants, in Greater London, Thames Valley, Surrey, Gloucestershire, Wiltshire and Kent. Thames Water's customers comprise 27% of the UK population.

Thames Water recover approximately 18MW (156GWh a year), or 12.5% of its total energy requirements from renewable electricity generated from biogas collected from sewage. Further biogas capacity, utilising 'fatbergs' removed from London's sewers and substantial solar farms have enabled the company to announce a 2015/16 target of generating 36MW (318GWh a year), or 20% of its total energy requirements from renewable sources.

The Didcot sewage treatment project was one of five demonstration renewable gas grid injection projects announced by British Gas in 2010. Other projects included renewable gas generated from food waste, farm crops, manufacturing waste (potters waste), farm waste slurry and brewery waste.

2.

3.

4.

5.

6.

RENEWABLE GASES

The Didcot renewable gas grid injection plant utilises sewage gas from around 200 homes which was previously flared. The plant first separates the solid part of sewerage and then treats the solids in two anaerobic digesters, where bacteria break down biodegradable material, yielding a biogas. The biogas that is produced typically contains 65% methane and 35% carbon dioxide. It may also contain hydrogen sulphide, moisture and siloxanes. Natural gas on the other hand contains around 90% methane, with ethane, propane, butane, carbon dioxide and nitrogen making up the rest.

The process to clean anaerobic digester biogas is necessary to strip out the other elements to produce biomethane or substitute natural gas with a methane content of 97–98%. This makes it suitable to be injected into the gas grid pipeline at an acceptable quality standard and as close a match as possible to natural gas.

The three main steps involved in the clean-up process are the removal of the carbon dioxide and trace contaminants, the removal of the hydrogen sulphide and drying to remove water content. The biogas is then injected with 3–7% propane, bringing the gas up to the required calorific specification, around 39MJ/m³ to enable the substitute natural gas to be injected into the gas grid by Southern Gas Networks who own and operate the Southern Region gas distribution network. The renewable gas injected into the gas grid is sold by British Gas to their customers. The digestate produced by the anaerobic digesters is sold as a fertiliser by Thames Water.

The whole process takes 20 days from flushing the toilet to receiving the renewable gas it has produced back again to heat 200 homes but is continuous thereafter.

FIGURE 80: DIDCOT SEWAGE TREATMENT PLANTS RENEWABLE GAS GRID INJECTION CONCEPT
SOURCE: BBC NEWS

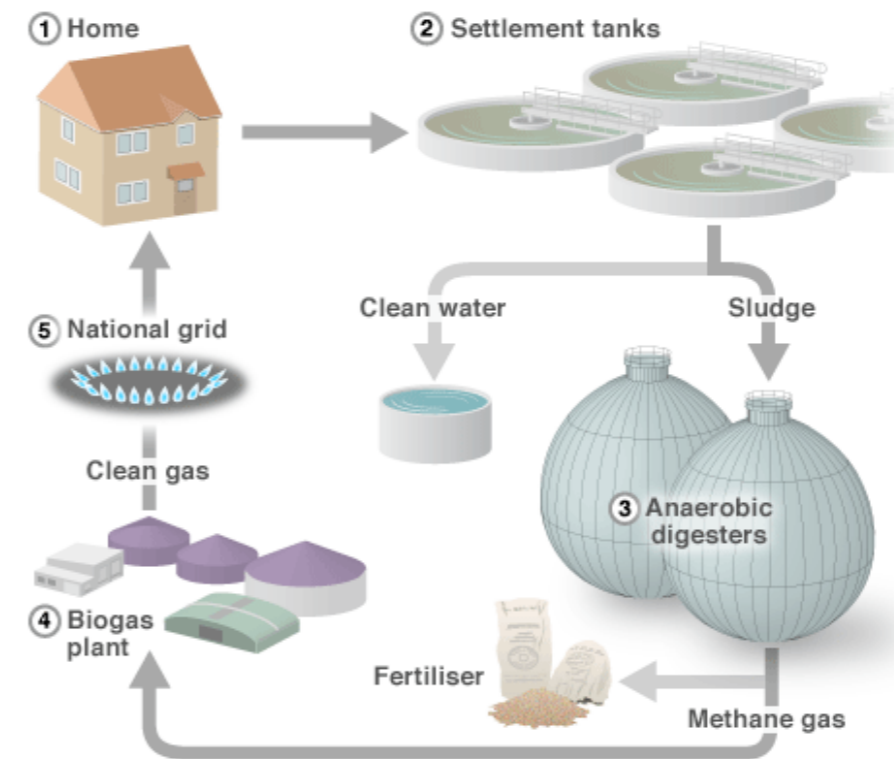

Feedstock:	Wastewater from 200 homes
Gas Grid Injection Capacity:	130m ³ /hour
Annual Gas Grid Injection:	6.5GWh (23,400GJ)
Annual saving:	1,440 tonnes CO _{2-e}

1 RENEWABLE ENERGY RESOURCES

2 RE-THINKING RENEWABLE ENERGY

3 RENEWABLE ENERGY FOR THE CITY OF SYDNEY

4 PERFORMANCE MEASURES

5 ENABLING THE MASTER PLAN

6 CASE STUDIES

1.

RENEWABLE GASES

POUNDBURY RENEWABLE GAS GRID INJECTION, DORSET, UK

Biodegradable waste currently going to landfill, along with manures, slurries and sewage sludge, provide a significant source of feedstock for biomethane production. Diversion of waste that would otherwise end up in landfill has the additional benefit of reducing methane emissions from landfill. Of the potential 100TWhs of energy from biomass available in the UK up to 20TWh (72PJ) could be from biogas produced by anaerobic digestion. In addition, gasification of municipal waste and other wastes such as derived from broadacre crops will be available to produce synthesis gas or syngas. The organic fraction of this waste is referred to as bio-syngas or bio-SNG.

The National Grid has identified that renewable gases injected into the gas grid could supply up to 50% of UK residential gas demand by 2020. Much of the renewable feedstock to generate this renewable gas resource is either waste derived from agriculture, farming, sewage or landfill located in remote rural areas or the organic fraction of municipal waste located at collection or treatment depots where there is very little opportunity to utilise the cogeneration of waste heat from local electricity generation.

Using renewable gas for electricity generation would harness only 20–35% of the renewable energy generated whereas injecting renewable gas into the gas grid and utilising the gas for heating homes or cogeneration and trigeneration in cities could harness 80% of the renewable energy generated, less 10% grid losses if exported into the electricity grid. Not only is it much easier and more efficient to transport, store and utilise gas than electricity it also overcomes the intermittency of renewable electricity such as wind or solar. Renewable gas producers also have access to higher prices than available locally and can inject renewable gas into the gas grid continuously without the need for storage.

Anaerobic digestion is a natural process where, in the absence of oxygen, organic material is broken down by micro-organisms to produce biogas which is rich in methane. An additional benefit of anaerobic digestion is that it produces a bi-product called digestate which can be used as organic fertiliser on arable crops. Digestate retains all of the nutrients (nitrogen, phosphorus and potassium) for fertilising local farmland and acting as a good soil conditioner.

The Poundbury renewable gas grid injection plant is owned and operated by JV Energen, a joint venture between local farmers and the Duchy of Cornwall established to provide a renewable energy solution for the Duchy's development at Rainbarrow Farm, Poundbury, Dorset. Founded in 1337 the Duchy of Cornwall is a crown body principally responsible for managing the land and properties of the eldest son of the reigning British monarch – currently HRH Prince Charles, who was consulted at every stage of the project and who opened the project in 2012.

Rainbarrow Farm is situated on Duchy of Cornwall land outside of the village of Poundbury and was built as part of the Prince of Wales's sustainable community designs for the town. The town of Poundbury is expected to be fully completed by 2025 when it will house approximately 5,000 people and provide 2,000 jobs in the

factories, offices and general facilities across the site. Poundbury is already home to 2,000 people and provides employment for 1,600 people and is home to 140 businesses. The renewable gas grid injection plant will supply gas for up to 56,000 homes in Poundbury and the local surrounding area via the national gas grid.

The Poundbury renewable gas grid injection plant uses around 41,000 tonnes of maize, grass and potato waste grown by local farmers as well as organic waste from nearby factories, including chicken manure, Dorset Cereals and the House of Dorchester Chocolate Factory. The waste is digested in an anaerobic digester which produces biogas with 96% methane content which is upgraded and converted into biomethane and injected into the natural gas grid as a substitute natural gas by Southern Gas Networks who own and operate the Southern Region gas distribution network.

Some of the renewable gas is used to run an on-site 400kW combined heat and power or cogeneration engine to supply heat and electricity to the site. 50% of the generated electricity is exported to the electricity grid.

The plant also has the capacity to produce 23,000 tonnes of liquid and 8,000 tonnes of solid, renewable fertiliser a year. The digestate is used by local farmers in place of inorganic feedstock to significantly increase food production in arable crops and grass production for cattle.

<i>CHP Capacity:</i>	<i>400kW electricity / 430kW heat</i>
<i>CHP Annual Output:</i>	<i>3.2GWh pa electricity / 3.4GWh pa heat</i>
<i>Gas Grid Injection Capacity:</i>	<i>400m³/hour</i>
<i>Annual Gas Grid Injection:</i>	<i>20GWh or 72,000GJ</i>
<i>Annual saving:</i>	<i>4,435 tonnes CO_{2-e}</i>

FIGURE 81: POUNDBURY RENEWABLE GAS GRID INJECTION, DORSET, UK
SOURCE: JV ENERGEN



2.

3.

4.

5.

6.

RENEWABLE GASES

GOBIGAS AND BIO2G BIOMASS GASIFICATION RENEWABLE GAS GRID INJECTION, GOTHENBURG AND MALMO, SWEDEN

With 45% of its proportion of energy use provided from renewable sources Sweden can be considered as a mature low carbon economy compared to other countries. Renewable energy sources include hydro power, wind energy and renewable gases. District heating has been used in Sweden since the 1950s and is the commonest form of heating in apartment buildings with about 82% of apartments being heated in this way. District heating and cooling is also the main source of thermal energy supplying offices, commercial premises and public buildings. District cooling has been used in Sweden since the 1990s. Together, they represent more than 40% of the country's energy use.

Sweden has ambitious targets to provide 50% renewable energy by 2020, transport independent of fossil fuels by 2030, 40% reduction in greenhouse gas emissions by 2020 and zero net greenhouse gas emissions by 2050.

Electricity production is 51% renewable energy and 37% nuclear energy with the remaining 12% being made up of fossil-fuelled and biofuel-based production. However, electricity prices reached record levels in 2009/10 primarily due to low availability of the nuclear power stations which led to increased oil-fired power generation and imports from the Nord Pool. Sweden is moving away from fossil fuel power and nuclear energy and is likely to phase out nuclear energy by 2035. This will have to be replaced by renewable energy.

Natural gas was first introduced to Sweden in 1985 and has increased rapidly since the 1990s. The use of biofuels and renewable gases in the Swedish energy system has also increased from 10% of total energy supply in the 1980s to over 25% today. Most of the increase in bioenergy or renewable gases has occurred in industry and for cogeneration district heating, although use is also increasing in the residential and transport sectors. More than 230 renewable gas plants and more than 30 renewable gas grid injection plants are currently in operation. In addition, more than 110 public renewable gas refuelling stations are available for transport fuel gas.

Biomass is considered as a carbon neutral fuel as the amount of CO₂ released on burning biomass equals the uptake of CO₂ from the atmosphere during the growth of the biomass. Fuels like hydrogen, methane, Fischer-Tropsch diesel and methanol produced from biomass have the potential to become a carbon negative fuel, because part of the biomass carbon is separated as CO₂ in a concentrated stream during the production process. If this pure CO₂ stream is sequestered, these fuels can become CO₂ negative. If natural gas is replaced by biomethane produced by gasification there would be up to a 70% reduction in CO₂ emissions. If the pure CO₂ steam is not vented into the atmosphere but sequestered in, for example, a depleted natural gas field, the net CO₂ emissions would become negative by 70%.

Thermal gasification involves the production of a synthesis gas or syngas in a gasifier through the thermal breakdown of solid biomass into non-condensable gases. Gasification uses chemical reactions with steam and oxygen often added to promote the desired reactions. The raw syngas is a mixture composed mostly of hydrogen (H₂), carbon monoxide (CO), carbon dioxide (CO₂), water vapour (H₂O) and methane (CH₄) as well as smaller amounts of hydrogen sulphide (H₂S) and light hydrocarbons such as ethane. Syngas cleaning removes the particulates, tars, H₂S and any other trace elements. To produce renewable gas, H₂ and CO are converted to methane via a process called 'methanation'. The CO₂ is then removed.

Methane produced from biomass or municipal or agriculture or farming waste is referred to as biomethane, renewable gas or bio-substitute natural gas (Bio-SNG). The composition of biomethane is similar to natural gas, making replacement of natural gas by biomethane straightforward.

E.ON Nordic is developing major renewable gas grid injection plants throughout Sweden. So far, 1.5TWh of renewable gas plants have been implemented with a potential for a further 15TWh developed by anaerobic digestion and 59TWh developed by thermal gasification. E.ON Nordic's vision for Sweden is to develop 20TWh of renewable gas grid injection by 2020 comprising 10TWh from anaerobic digestion and 10TWh from gasification. E.ON Nordic is part of the E.ON AG Group, the world's largest privately owned energy company, so is well placed deliver its vision against Swedish energy policy.

E.ON implemented a demonstration biomass gasification plant at Varnamo near Gothenburg in 1999. This generated 6MW of electricity and 9MW of heat. This was followed by the Goteborg Energi GoBiGas thermal gasification of biomass for renewable gas project at Rya near Gothenburg harbour.

Goteborg Energi is an energy services company owned by the City of Gothenburg providing utility services to more than 300,000 customers in Greater Gothenburg, including cogeneration/trigeneration, electricity, natural and renewable gases, fibre optic cabling and technologies for consumers not connected to the district heating network. Goteborg Energi supply heating to 90% of all apartment blocks in Gothenburg with 1,000km of district heating networks with decentralised cooling for commercial customers. The district heating network is 17% renewable fuelled.

Phase 1 of the GoBiGas project will produce 20MW of renewable gas injected into the gas grid in 2013 and Phase 2 will produce a further 80MW of renewable gas for injection into the gas grid. The total efficiency of Phase 1 is 90% and operates for 8,000 hours a year. The market for this gas is cogeneration district heating, renewable methane for industrial processes and transport fuel. Phase 2 will utilise 0.5Mt/yr of low quality pulpwood and forestry residues.

1 RENEWABLE ENERGY RESOURCES

2 RE-THINKING RENEWABLE ENERGY

3 RENEWABLE ENERGY FOR THE CITY OF SYDNEY

4 PERFORMANCE MEASURES

5 ENABLING THE MASTER PLAN

6 CASE STUDIES

1.

RENEWABLE GASES

The E.ON Bio2G thermal gasification project near Malmo comprises forest residues dryer, wood pellets fuel handler, 345MW atmospheric indirect fluidised bed gasifier with thermal combustor, flue gas control and bag filter de-NOx as part of the gasification process and tar, sulphur and CO₂ removal, methanation and drying/upgrading for renewable gas grid injection as part of the methanation process. The combustor re-injects steam back into the gasifier and heat is utilised for the air preheater and hot water flue gas control/de-NOx process. Some of the renewable gas is used to run a 23MWe biomass integrated gasification combined cycle cogeneration turbine to supply heat and electricity to the site.

The plant has an inherent carbon dioxide (CO₂) removal of about 33% of the CO₂ with the potential to be carbon negative with the storage or re-use of the CO₂ as greenhouse fertiliser or in the drinks industry. The plant will also have the capacity to co-produce liquid nitrogen gas (N₂) and liquid biomethane or hydrogen (H₂) and carbon monoxide (CO) in bio-refinery.

FIGURE 82: GOBIGAS BIOMASS GASIFICATION RENEWABLE GAS GRID INJECTION – PHASE 1, GOTHENBURG, SWEDEN
SOURCE: GOTEBURG ENERGI



FIGURE 83: GOBIGAS BIOMASS GASIFICATION RENEWABLE GAS GRID INJECTION – PHASES 1 AND 2, GOTHENBURG, SWEDEN
SOURCE: GOTEBURG ENERGI



<i>Feedstock:</i>	<i>1Mt/yr low quality of pulpwood and forestry residues</i>
<i>CHP Capacity:</i>	<i>23MW electricity / 55MW heat</i>
<i>CHP Annual Output:</i>	<i>172.5GWh pa electricity / 412.5GWh pa heat</i>
<i>Gas Grid Injection Capacity:</i>	<i>21,000m³/hour (200MW)</i>
<i>Annual Gas Grid Injection:</i>	<i>1,500GWh (5.4PJ)</i>
<i>Annual saving:</i>	<i>120,360 tonnes CO_{2-e} 354,000 tonnes CO_{2-e} (if sequestered)</i>

2.

3.

4.

5.

6.

RENEWABLE GASES

KYLMÄJÄRVI 2 MUNICIPAL WASTE GASIFICATION RENEWABLE GAS FUELLED COGENERATION NETWORK, LAHTI, FINLAND

Finland is a world leader in precinct scale decentralised energy accounting for 50% of the total heating market of which 80% is produced by cogeneration or trigeneration. Over 90% of apartment blocks, more than 50% of all terraced houses and the bulk of public buildings and business premises are connected to a district heating and/or cooling network.

Renewable energy accounts for 25% of primary energy consumed which is the third highest in the European Union. Finland is also among the leading countries in the use of biomass in energy production. Renewable gases and other bio energy accounts for 20% of all primary energy consumption, currently the second highest in the European Union. A new feed-in tariff was established in 2011 to promote the production of electricity based on wind power, renewable gases and biofuels to deliver Finland's 38% renewable energy target by 2020.

The Finnish Government's long term aim is to reduce greenhouse gas emissions by 80% below 1990 levels by 2050 – "Low Carbon Finland 2050".

The City of Lahti is located 100km north-east of Helsinki and has a population of 102,000 people but serves an economic region with 200,000 inhabitants. Through a combination of recycling of waste and waste to energy only 6% of all waste is disposed to landfill. As part of its policies to reduce waste being disposed to landfill, to increase renewable energy and to reduce greenhouse gas and other noxious emissions the City, through the City owned Lahti Energia, built its first gasification plant, Kymjärvi 1, in 1998. This is a hybrid cogeneration plant using coal and gasified wood solid waste in an 85:15 ratio. This reduced the need to import 700,000 tonnes of coal a year and reduced carbon dioxide and sulphur dioxide by 10%, nitrogen oxides by 5% and particulates by 40%.

The Kymjärvi cogeneration district heating network covers the entire Lahti city area and supplies 7,600 customers with almost every building in Lahti connected to the network. The district heating network also supplies Nastola and Hollola city centre areas. Biogas is also generated by anaerobic digestion at Lahti's sewage treatment works which is converted into thermal energy and fed into Lahti's district heating network. Cogenerated electricity is supplied to 87,000 customers in the Lahti area and nationwide.

Consideration was later given to replace the hybrid gasification system with a renewable gas only gasification system since a syngas only plant would generate 40% more electricity per tonne of solid, mainly household waste, than hybrid firing. In addition, using such a gasification system would reduce the import of a further 170,000 tonnes of imported Siberian coal.

The Kymjärvi 2 municipal waste gasification renewable gas fuelled cogeneration plant began operation in 2012 and is operated as the primary cogeneration plant. The Kymjärvi 1 plant was retained for back-up in peak demand periods such as winter, when temperatures can drop to -30°C.

The plant's feedstock is garbage collected within a 200km radius from households, industry and construction sites and then processed by waste management companies to meet detailed standards set by Lahti Energia. Households separate waste into three recyclable wastes (waste carton, glass and metal + biowaste + energy waste). Finns do not regard garbage as garbage but as recyclable energy waste. The separately sorted energy waste is collected and shredded by waste management companies. Those waste management companies collecting industrial waste use BMH Technology's Tyrannosaurus solid recovered fuel separator-shredders to do both jobs. Processed waste is delivered to the plant's fuel depot as well as industrial and forestry wood waste.

The sorted waste or solid recovered fuel primarily consists of plastic, wood and paper that cannot be recycled and is sufficiently energy-rich to be gasified to produce syngas from mainly renewable fuels. After delivering the waste, suppliers are required to cut it into a size of about 6 cm and reduce any moisture content to below 20-30%. A sample from each truckload is tested by a laboratory at the entrance to Lahti Energia's weigh station. The economics of the project is such that Lahti Energia pays suppliers for delivering waste in this way which also incentivises waste management companies to comply with Lahti Energia's requirements.

After approval and unloading, the solid fuel is fed into two 7,500m³ silos from where it is conveyed 240 metres to two 80MW circulating fluidised bed gasifiers where it mixes with sand, limestone and air at a temperature of 900°C in the gasifier reactors. Under these conditions solid fuel breaks down into a synthesis gas or syngas. The hot syngas rises to the top of the gasifier and then onto a cooling system where the temperature is reduced to 400°C.

1 RENEWABLE ENERGY RESOURCES

2 RE-THINKING RENEWABLE ENERGY

3 RENEWABLE ENERGY FOR THE CITY OF SYDNEY

4 PERFORMANCE MEASURES

5 ENABLING THE MASTER PLAN

6 CASE STUDIES

1.

RENEWABLE GASES

The syngas does not burn in the reactor since there is insufficient oxygen for combustion. Cooling is used to clean the syngas of unwanted particles such as metal compounds and alkalis that re-solidify and fall to the bottom of the chamber which are then removed. This process purifies the syngas so that emissions are practically zero except for carbon dioxide produced during gasification. The gas impurities are removed inside 12 cooling chambers containing 300 ceramic candle filters each collecting unwanted particles while allowing the syngas to pass through. A nitrogen pulse every minute ejects collected dust which falls to the chamber floor for removal. Studies are under way to recycle the ash for agriculture or re-combustion.

The clean syngas is fed into the cogeneration station's boiler to produce steam which in turn produces electricity and district heating hot water via two 25MWe turbines, operating at 540°C under 121 bars, delivering nearly 90% overall efficiency. Unlike incineration, the temperature and pressure can be run at these levels because the corrosive metals and alkalis have been extracted during cleaning, generating nearly three times as much electricity than incineration or nearly twice as much electricity than hybrid fossil fuel/solid recovered fuel gasification.

2.

3.

4.

5.

6.

FIGURE 84: KYLMÄJÄRVI 2 MUNICIPAL WASTE GASIFICATION RENEWABLE GAS FUELLED COGENERATION NETWORK, LAHTI, FINLAND
SOURCE: LAHTI ENERGIA



<i>Feedstock:</i>	<i>250,000 tonnes of municipal waste</i>
<i>Capacity:</i>	<i>50MW electricity 90MW heat</i>
<i>Annual Output:</i>	<i>300GWh pa electricity 600GWh pa heating</i>
<i>Fuel Storage:</i>	<i>15,000m³ (two 7,500m³ silos)</i>
<i>Annual saving:</i>	<i>180,000 tonnes CO_{2-e}</i>

RENEWABLE GASES

GERMANY BIOGAS GAS GRID INJECTION PROGRAM

By 2030, up to 650 billion kWh of primary energy could be delivered by renewable gases, with 370 billion kWh from biogas. Austria, Netherlands, Germany, Sweden, Switzerland and the UK are already developing a renewable gas grid injection market with Denmark, France and Italy just starting their renewable gas market.

In 2011, around 17% of electricity, 8% of heat and 6% of fuel used in Germany was generated from renewable sources. A further 17% of electricity generation was generated from nuclear energy with the remainder of energy supply coming from fossil fuels. However, Germany also formally announced plans to abandon nuclear energy completely by 2022 and the gap will have to be filled by renewable energy. The Renewable Energy Sources Act (Erneuerbare-Energien-Gesetz, EEG) became law in 2000 and was amended in 2004, 2009 and 2012. The 2012 Act set a target to increase the share of renewable energy to 40% by 2020 and to 80% by 2050.

The three main principles of the EEG are:

- Investment protection through guaranteed feed-in tariffs and connection requirements.
- No charge to Germany's public purse.
- Innovation by falling feed-in tariffs (degression of 1% a year) exerts cost pressure on manufacturers leading to technologies becoming more efficient and less costly.

Another outcome of the EEG is to move Germany away from fossil and nuclear fuels and centralised electricity infrastructure towards renewable energy sources and a decentralised electricity infrastructure, taking advantage of decentralised thermal energy networks and renewable gases. The decentralised energy approach generates greater economic benefits than the cost of the EEG through avoided grid network investment and charges and other savings such as reduced environmental impacts and related economic benefits. According to a European Commission study, the net benefit of the EEG exceeds the additional costs of initial investment by 3.2 billion Euros. In addition, the EEG generates more competition, more jobs and more rapid deployment for manufacturing.

Next to renewable gases, hydropower, wind power and solar power as well as waste disposal, sewage and mine gas are supported. This has led to innovation in the German energy system, particularly for renewable gases injected into the gas grid. This case study relates to renewable gases derived from agriculture and farming via anaerobic digestion only and excludes renewable gases from gasification and other renewable gases. Therefore, renewable gases derived from these latter opportunities are in addition to the renewable gases identified in this case study.

Biomethane (biogas and syngas) or renewable gases is created from indigenous, renewable and organic waste products. The EEG sets a target to exploit 6 billion Nm³ (60 billion kWh) of biogas by 2020 and 10 billion Nm³ (100 billion kWh) of biogas by 2030.

To develop and implement the rapid roll out of renewable gas injected into the gas grid the Federal Government's German Energy Agency developed the 'biogaspartner' project to provide a leading platform for the injection of renewable gas into the natural gas network and the utilisation of injected biomethane. Stakeholders along the whole supply chain are joining the project to develop the market and current membership stands at 60 companies and market players.

The biogas grid injection industry currently employs 11,000 people, mainly in rural areas, and 5–10% of farm income is generated from biogas production.

Since the 2004 Act there are now more than 7,000 anaerobic digestion plants in Germany and since the 2009 Act there has been a rapid roll out of renewable gas grid injection plants and there are now more than 170 such plants, including retrofits, operating in Germany injecting 105,615m³ per hour of renewable gas into the gas grid, equating to 8.5 billion kWh of renewable gas in the gas grid network a year.

1 RENEWABLE ENERGY RESOURCES

2 RE-THINKING RENEWABLE ENERGY

3 RENEWABLE ENERGY FOR THE CITY OF SYDNEY

4 PERFORMANCE MEASURES

5 ENABLING THE MASTER PLAN

6 CASE STUDIES

1.

RENEWABLE GASES

In order to maximise the energy efficient use of renewable gas and to maximise the reduction in greenhouse gas emissions the 2009 Act limits the use of renewable gas in the gas grid to:

- Cogeneration and trigeneration
- Admixing with natural gas for heating under the Renewable Heat Law
- Transport applications.

Renewable gas cannot be used for power generation only.

The Renewable Energies Heat Act 2009 requires 14% of the German heat demand (final energy) to be produced from renewable energy sources by 2020.

2.

3.

4.

5.

6.

FIGURE 85: BIOGAS GRID INJECTION PLANT AT RONNENBERG FOR HANNOVER CHP NETWORK, GERMANY
SOURCE: ENERGYCITY (STADTWERKE HANNOVER AG)



<i>Feedstock Area:</i>	<i>1.6 million hectares</i>
<i>CHP Capacity:</i>	<i>5.11GW electricity (end use) / 4.33GW heat (end use)</i>
<i>CHP Annual Output:</i>	<i>41,650GWh pa electricity / 35,300GWh pa heat</i>
<i>Gas Grid Injection Capacity:</i>	<i>1,166,670m³/hour (11.1GW)</i>
<i>Annual Gas Grid Injection:</i>	<i>100,000GWh (360PJ)</i>
<i>Annual saving:</i>	<i>11,420,200 tonnes CO_{2-e} (displacing natural gas CHP emissions)</i>

RENEWABLE GASES

'POWER TO GAS' RENEWABLE ELECTRICITY TO RENEWABLE GAS PROJECT, FALKENHAGEN, GERMANY

In 2011, around 17% of electricity, used in Germany was generated from renewable sources. If Germany is to meet its targets of supplying 33% of its electricity from renewable energy by 2020, at least 50% by 2030 and 80% by 2050, it must find a way to store huge quantities of electricity in order to overcome the intermittency of renewable energy. The intermittency of wind and solar make it impossible for German electricity utilities to provide affordable, reliable power to industry and consumers, at the high level of penetration that Germany is seeking.

One of the outcomes of the Renewable Energy Sources Act (Erneuerbare-Energien-Gesetz, EEG) is to move Germany away from a centralised electricity infrastructure towards a decentralised electricity infrastructure, taking advantage of expanded decentralised thermal energy networks and renewable gases which will significantly reduce the need for supplying heating and cooling from electricity. However, there is still a need to overcome the intermittency of wind and solar which will be significantly expanded under the EEG. Currently, windmills have to be switched off when there is an oversupply of wind energy and this renewable energy is lost.

Converting renewable electricity to renewable gas is a new way of storing surplus energy from renewable sources, such as solar and wind power, until it is required, balancing long term fluctuations in generation. The conversion process involves using renewable electricity to electrolyse water, producing hydrogen for injecting into the gas grid. Under existing gas regulations, up to 5% hydrogen can be added to the natural gas grid without any problems, and in the medium term experts expect up to 15% can be injected into the gas grid. This means that Germany's current entire renewable electricity output could be stored in the German gas grid. This makes the gas grid a storage system for renewable electricity from weather-dependent renewables.

The total length of the gas infrastructure in the European Union is 1.8 million km long and contains 120 underground gas stores supplying 102 million customers. This makes the existing gas grid an ideal conduit for the transportation, distribution and storage of renewable gases (hydrogen, biomethane and bio-SNG) for power generation, cogeneration, trigeneration, heating and transport. Renewable hydrogen capacity can be increased in the gas grid above 15% by converting hydrogen into syngas or bio-SNG via a 'methanation' process. Germany alone has a natural gas storage reservoir equivalent to more than 200TWh.

Converting renewable electricity to renewable hydrogen injected into the gas grid has a typical efficiency of 70% and converting renewable electricity to syngas or bio-SNG injected into the gas grid has a typical efficiency of 56% for renewable electricity that would otherwise be lost. This compares with the 33% efficiency of a typical coal fired power station before grid losses.

In 2012, E.ON started construction of the 'power to gas' plant in Falkenhagen to convert surplus wind power into hydrogen by electrolysis from 2013. The hydrogen will be carried via a pipeline to a connection point on the natural gas grid and injected into the high pressure transmission pipeline. This project will be one of the first projects in the world to demonstrate how surplus renewable electricity can be stored in the gas grid, removing the link between generation and demand.

The Falkenhagen wind farm in Brandenburg comprises 18 wind turbines with a total capacity of 14.2MW generating 35GWh of electricity a year. Surplus electricity is taken from the wind farm and dissolved in water by electrolysis into hydrogen (H₂) and oxygen (O₂). The hydrogen gas is then injected into the natural gas pipeline.

The 'power to gas' plant consists of a 2MW energy storage or hydrogen production facility incorporating electricity transfer, rectifier and electrolyser units, hydrogen gas compression, low voltage uninterruptible power supply system and automation, measurement and analysis systems. Hydrogen gas is transported and injected into the natural gas transmission pipeline, blending 2% of hydrogen gas with natural gas.

<i>Wind Capacity:</i>	<i>14.2MW</i>
<i>Surplus Wind:</i>	<i>2MW</i>
<i>CHP Capacity:</i>	<i>0.9MW electricity (end use) / 0.8MW heat (end use)</i>
<i>CHP Annual Output:</i>	<i>4,165MWh pa electricity / 3,530MWh pa heat</i>
<i>Gas Grid Injection Capacity:</i>	<i>360m³/hour (2MW max)</i>
<i>Annual Gas Grid Injection:</i>	<i>10GWh or 36,000GJ</i>
<i>Annual saving:</i>	<i>1,142 tonnes CO_{2-e} (displacing natural gas CHP emissions)</i>

FIGURE 86: E.ON INNOVATION CENTRE ENERGY STORAGE 'POWER TO GAS' PROJECT, FALKENHAGEN, GERMANY
SOURCE: HYDROGENICS



1 RENEWABLE ENERGY RESOURCES

2 RE-THINKING RENEWABLE ENERGY

3 RENEWABLE ENERGY FOR THE CITY OF SYDNEY

4 PERFORMANCE MEASURES

5 ENABLING THE MASTER PLAN

6 CASE STUDIES

1.

RENEWABLE GASES

NORTH SEA 'POWER TO GAS' PLATFORM, EUROPE

Eleven leading companies in Europe established the North Sea Power to Gas Platform to further develop the concept of 'Power to Gas' or the conversion of renewable electricity into renewable gas. Power to gas will play an increasingly important role in Europe's future energy system, as it reduces the intermittency of renewable electricity such as solar and wind by converting surplus renewable electricity into renewable gases which can be stored in Europe's existing gas network. These gases have a wide range of uses such as transportation, domestic heating, as feedstock for the chemical industry, and power generation such as cogeneration and trigeneration.

The eleven companies forming the North Sea Power to Gas Platform are:

1. DNV KEMA – An international global consultancy with more than 2,300 experts in over 30 countries. Norwegian company DNV was founded in 1864 and the former Dutch electricity industry testing house KEMA was established in 1927.
2. Fluxys Belgium – The natural gas transmission grid, storage and LNG terminals network services provider in Belgium. Also transmission networks in Germany and Switzerland. The 18 interconnection points on the Belgium grid opens the network to gas flows from the UK, Norway, the Netherlands, Russia and all LNG producing countries. The Belgium grid also serves as the crossroads for transmission flows of natural gas to the Netherlands, Germany, Luxembourg, France, the UK and Southern Europe.
3. Energinet.dk – The electricity and gas transmission network services provider in Denmark owned by the Danish Government.
4. Hydrogenics – Canadian company with over 60 years of experience in designing, manufacturing, building and installing industrial and commercial hydrogen systems around the globe. European manufacturing plant located in Belgium and Germany.
5. Maersk Oil – Danish oil and gas company.
6. Alliander – Largest electricity and gas grid operator in the Netherlands with more than 3 million customers.
7. Gasunie – National gas transmission network services provider in the Netherlands (12,000km) and part of Germany (3,100km). Also majority shareholder in the BBL gas transmission pipe network between the Netherlands and the UK and shareholder in the NEL gas transmission pipe network between the Nord Stream from Russia via Scandinavia and the German gas system. Also LNG terminals and underground gas storage. Owned by the Dutch Government.
8. TenneT – National electricity transmission network services provider in the Netherlands. Also one of the four electricity transmission network services provider in Germany. Owned by the Dutch Government.
9. ITM Power – UK company specialising in fuel cells and electrolysers, including hydrogen refuelling stations and 'power to gas' technologies.
10. National Grid – National electricity and gas transmission network services provider in the UK. Also owns 10 US network companies with 14,000km of electricity and gas transmission networks in Massachusetts, New Hampshire, New York, Rhode Island and Vermont.
11. Open Grid Europe – Germany's largest gas transmission network services provider (12,000km) which is the key European hub for bulk gas shipments from Russia and Norway. Owned by Australian banking, financial, investment funds management services company Macquarie Group headquartered in Sydney.

2.

3.

4.

5.

6.

RENEWABLE GASES

The North Sea Power to Gas Platform is a joint body, based on an integrated network of stakeholders, aiming to further develop the concept of 'power to gas' in the countries surrounding the North Sea. The Platform collaborates with the European Gas Research Group, the Mediterranean Power to Gas Platform, as well as gas shipping companies, NGO's, utilities, energy technology providers, electricity and gas transmission and distribution network operators.

Power to gas is the conversion of electricity into a gaseous energy carrier such as hydrogen or methane. Power to gas enhances the energy transition from fossil fuels to renewable energy since it can be adapted for:

- Utilising the excess electricity from intermittent sources such as solar and wind energy;
- Energy storage (both short term and seasonal);
- Long distance energy transport when the electricity transmission grid is inadequate; and
- Production of gas or chemicals from renewable sources as feedstock for industry and mobility.

The share of electricity from renewable sources in the European electricity mix is increasing. As electricity generation from wind and solar fluctuates, the match between renewable electricity supply and demand is becoming increasingly challenging. At the same time, there are additional challenges to transmit the increasing volumes of renewable electricity from wind or solar farms to end users. The existing gas infrastructure can accommodate large volumes of electricity converted into gas, particularly when renewable electricity is larger than the electric capacity or when renewable electricity generation exceeds demand. As a result 'power to gas' enables the share of renewables in the energy mix to increase, making this innovation an important technology in achieving a carbon free gas supply by 2050.

Power to gas is of particular significance for the North Sea area as its on- and off-shore natural gas infrastructure is well developed. In addition, the combined generating capacity of offshore wind farms on the North Sea could reach around 100GW by 2030, while the solar PV capacity installed in countries surrounding the North Sea increased to 35GW in 2012 and is expected to increase to 60GW by 2020.

Based on recent Germany and UK studies it is anticipated that the penetration of wind and solar electricity will give rise to up to 40% surplus renewable electricity by 2020–2025 which will have to be switched off at times when generation exceeds demand unless the surplus renewable electricity is converted to renewable gas by power to gas technologies, injected and stored in the gas grid for utilisation later when demand exceeds renewable electricity generation. Renewable gas in the gas grid also provides a renewable energy pathway for transport applications.

The European Union (EU-27) currently has a working gas volume of 82 billion cubic metres (3,135PJ) and is expected to grow to 132 billion cubic metres (4,915PJ) by 2025. Therefore, the existing gas grid provides more than enough energy storage to transmit and store surplus renewable electricity as renewable hydrogen or substitute natural gas that would be needed to balance the European Union's energy supplies based on a 100% renewable energy system. Europe has up to 122 days of gas storage capacity compared to 4–6 hours utility scale electricity storage capacity.

Transporting renewable electricity as a renewable gas in the existing gas grid is also more economic than transporting renewable electricity in the electricity grid. The Technical Association of the European Natural Gas Industry, Marcogaz, says that transporting electricity is 20 times more expensive than transporting the same amount of energy via a gas pipeline. At the same time the pipeline is invisible as it is buried underground and the gas industry is used to storing energy during the summer for use during the winter periods.

Utilising the existing gas network for renewable gas derived from renewable electricity also enables the economic long distance transportation of solar energy from countries with a good solar resource and wind energy from countries or locations with a good wind resource, such as the North and Mediterranean Seas, to countries or regions with a poor solar or wind resource. The gas infrastructure (transport, storage and distribution) is immediately available and storing electricity as a renewable gas minimises the need for expensive new electricity grid power lines which has driven up electricity prices across Europe.

1 RENEWABLE ENERGY RESOURCES

2 RE-THINKING RENEWABLE ENERGY

3 RENEWABLE ENERGY FOR THE CITY OF SYDNEY

4 PERFORMANCE MEASURES

5 ENABLING THE MASTER PLAN

6 CASE STUDIES

1.

RENEWABLE GASES

The conversion process involves using renewable electricity to electrolyse water, producing hydrogen for injecting into the gas grid. Hydrogen can be injected into the gas grid by up to 15% concentration. This avoids any potential steel pipeline embrittlement whilst maintaining combustion appliance performance with a slight increase in efficiency. Beyond 15% concentration, the hydrogen gas would need to be converted into syngas and then into a substitute natural gas via the methanation process for injection into the gas grid.

Converting renewable electricity into renewable hydrogen injected into the gas grid currently has a typical efficiency of 70% and converting renewable electricity into substitute natural gas currently has a typical conversion efficiency of 56–58%. However, technology advancement will see hydrogen conversion efficiencies of 85–90%. The US Department of Energy has set an efficiency target of 85% by 2017 for the technologies that it is supporting. This will also increase the substitute natural gas conversion efficiency to 68–72%. This compares with the 33% efficiency of a typical coal fired power station before grid losses.

Total Wind and Solar Capacity: based on 160GW
Surplus Wind/Solar Capacity: 37.2GW (40% surplus less conversion efficiencies)
Annual Output: 70,097GWh pa
Gas Grid Injection Capacity: 6,696,000m³/hour
Annual H₂/CH₄ Gas Grid Injection: 70,097GWh or 253PJ
Annual saving: 59,822,763 tonnes CO_{2-e} (based on EU 27 emissions)
147,845,620 tonnes CO_{2-e} (based on NSW emissions)

2.

3.

4.

5.

6.

FIGURE 87: NORTH SEA POWER TO GAS PLATFORM

SOURCE: RE NEWS/SPACE DAILY/WIKIMEDIA COMMONS/NORTH SEA POWER TO GAS PLATFORM



FIGURE 88: NORTH SEA POWER TO GAS PLATFORM SCHEMATIC

SOURCE: NORTH SEA POWER TO GAS PLATFORM

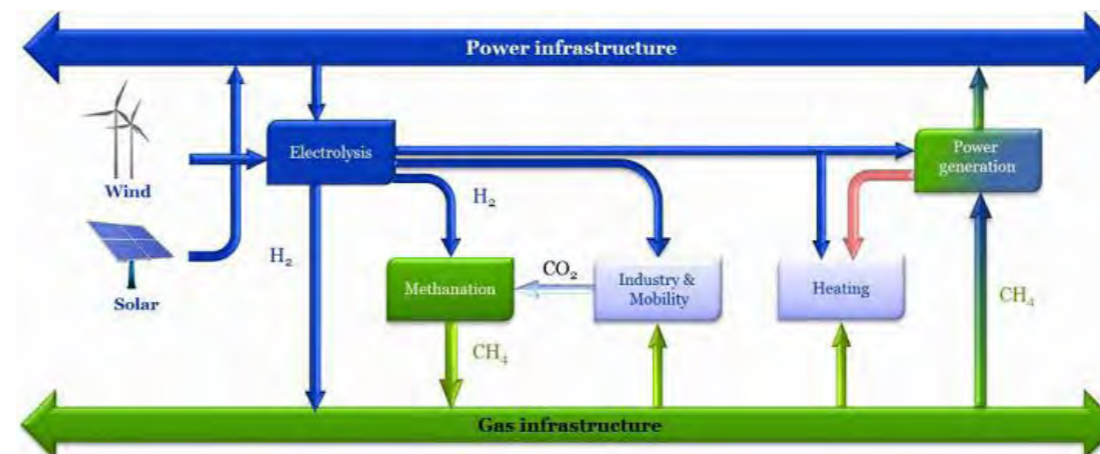

COMMUNITY RENEWABLE ENERGY

BAYWIND ENERGY – FURNESS WIND FARM, HARLOCK HILL, CUMBRIA, UK

Baywind Energy co-operative was the first co-operative to own wind turbines in the United Kingdom.

Baywind Energy was modelled on the similar wind turbine and other renewable energy cooperatives that are common in Scandinavia, Germany and the United States and was founded as an Industrial and Provident Society in 1996. It has now over 1,300 members, each with one vote. A proportion of the profits are invested in local community environmental initiatives through the Baywind Energy Conservation Trust.

Harlock Hill is a 2.5MW wind farm consisting of 5 wind turbines, each rated at 500kW with a hub height of 53m. The site is located in the Morecambe Bay area about 10km from Barrow-in-Furness and following a community competition the wind farm was renamed as Furness Wind Farm in 2009 to reflect the local community nature of the project. The wind farm generates enough renewable electricity to supply 1,100 homes.

The first share offer in 1996, raised £1.2 million (\$1.8 million) to buy two wind turbines at the Harlock Hill site. In 1998, the second share offer raised a further £670,000 (\$1,005,000) to buy one wind turbine at the nearby Haverigg II site. Preference was given to local investors, so that the community shares the economic benefits from their local wind farm. Around 43% of existing Baywind shareholders live either in Cumbria or North Lancashire with a wider number from the North West Region.

A cooperative society operates much like a limited company except that the voting rights are distributed equally amongst the members, regardless of the number of shares held. Baywind Energy has a minimum shareholding of 300 and a maximum (by law) of 20,000. Hence a stake in the cooperative is within easy reach of almost anyone but no single individual or organisation can have a controlling interest. The board comprises seven members as directors who have the skills and experience to conduct the business of the cooperative. The Board is elected by the whole of the membership at the Annual General Meeting and is supported by a full time paid administrator, who is also a Director.

Both share offers qualified for the Enterprise Investment Scheme tax relief. Qualifying shareholders received 20% tax relief on their initial investment of £500 or more.

All profits derived from electricity generation are paid back to the shareholders. In 2012, the return on investment was 8.3% (10.4% with tax relief).

The cooperative uses local contractors for site development, maintenance and support. The wind farm is visited by hundreds of school children and adults on educational visits and Baywind Energy funds environmental books for local schools. The Baywind Energy Conservation Trust fund financed by 0.5% of turnover by the cooperative, promotes energy conservation in the local community. The energy conservation trust provides information and grants for energy efficiency measures within the locality of the turbines to individual homes and community organisations. In addition, £112,000 (\$168,000) a year in economic benefits is provided by the wind farm.

Baywind Energy is currently developing a repowering project to replace the wind turbines with five 2.3MW turbines increasing the installed capacity from 2.5MW to

FIGURE 89: BAYWIND ENERGY – FURNESS WIND FARM, HARLOCK HILL, CUMBRIA, UK
SOURCE: RENEWS



11.5MW and generation from 10GWh a year to more than 60GWh a year which will supply electricity to 6,400 homes. Reduction in greenhouse gas emissions will also increase from 5,900 tonnes a year to 26,000 tonnes a year. The new wind turbines will have a hub height of 64m and a maximum height to blade tip of 99.5m. The optimum wind speeds will be 4m/s to 28m/s.

Installed in 1996, the existing wind farm has an expected life of 20 years. The new wind farm will have an expected life of 25 years. The new wind farm was approved by Barrow Borough Council in 2013.

The existing wind farm was developed before the regulatory barriers to decentralised energy were removed and electricity therefore, was exported to the grid as part of the wholesale market. The new wind farm will be able to sell electricity directly to customers and GlaxoSmithKline has registered an interest in a power purchase agreement for their factory in Ulverston, Cumbria, which will improve the economics of the wind farm.

Baywind Energy will run a new share offer for the new wind farm, offering a reduced share price of £100 (\$150) rather than £250 (\$375) for residents living within the local postcodes to encourage local members and local ownership of the project. The Community Benefit Fund will also be increased to £35,000 (\$52,500) a year and the local Council will be able to retain £4 million (\$6 million) of business rates in accordance with changed UK Government policy, from April 2013.

<i>Ownership:</i>	<i>Community Owned Cooperative</i>
<i>Capacity:</i>	<i>2.5MW</i>
<i>Optimal Wind speeds:</i>	<i>3.5m/s to 25m/s</i>
<i>Annual Output:</i>	<i>10GWh pa</i>
<i>Annual saving:</i>	<i>5,900 tonnes CO_{2-e} (based on UK grid emissions) 10,600 tonnes CO_{2-e} (based on NSW grid emissions)</i>

1 RENEWABLE ENERGY RESOURCES

2 RE-THINKING RENEWABLE ENERGY

3 RENEWABLE ENERGY FOR THE CITY OF SYDNEY

4 PERFORMANCE MEASURES

5 ENABLING THE MASTER PLAN

6 CASE STUDIES

1.

COMMUNITY RENEWABLE ENERGY

WESTMILL SOLAR COOPERATIVE – WESTMILL SOLAR PARK, NEAR WATCHFIELD, OXFORDSHIRE, UK

Westmill Solar Cooperative is an industrial and provident society that owns Westmill Solar Park, the largest community owned photovoltaic power station in the world.

The project was originally conceived by the pioneer behind the neighbouring Westmill Wind Farm Cooperative which was established in 2004 with 2,000 members. The wind farm has a capacity of 6.5MW, comprising five 1.3MW turbines. The solar power station commenced generation in 2011 and Westmill Solar Cooperative acquired the solar park in 2012, under an option agreement with the original developers. It raised the necessary finance through public and private share offers and a senior debt bond with a pension fund.

Westmill Solar Park is a 5MWp solar photovoltaic power station comprising 21,000 solar panels. The site is located on 30 acres (12 hectares) near to Watchfield on the Wiltshire/Oxfordshire border, just off the A420. The solar park generates enough renewable electricity to supply 1,400 homes.

The Cooperative invited members through a public share offer, launched in 2012. Despite the tight timetable caused by the expiry date of the option, the issue was 50% over-subscribed. However, all applicants were accepted as members although they may not hold as many shares that they applied for. This raised £4 million (\$6 million AUD) from around 1,650 members. An additional £2 million (\$3 million AUD) was raised by a private placement of B-shares, mainly from members who had subscribed to the original issue. The Cooperative raised the balance of finance required in the form of a 23½ year senior debt bond. This was arranged by Lancashire County Council Pension Fund, in what is believed to be the first major funding by a local authority in a community owned energy infrastructure.

A proportion of the profits are invested in local low carbon projects in the area through the Westmill Sustainable Energy Trust, originally established by the Westmill Wind Farm Cooperative. The Trust is managed by three trustees and a network of volunteers who act as advocates and together they have hosted 5,000 visitors who have been informed and inspired by their visit to Westmill Solar Park.

All profits derived from electricity generation are paid back to the shareholders. The return on investment is expected to be 11% a year on average for the 24 year period of the project. In 2012, the solar park generated 15% more renewable electricity than anticipated providing an increased return on investment for that year.

FIGURE 90: WESTMILL SOLAR COOPERATIVE – WESTMILL SOLAR PARK, NEAR WATCHFIELD, OXFORDSHIRE, UK
SOURCE: ETHEX



In the first 8 years, return on investment should average 9% a year, rising to 22% annually in the second 8 year period, then up to 43% a year in the final period. The reason for this is that the initial lower rates take into account the original capital costs as well as those of launching the share offer itself. Members will also receive their capital back in full over the life of the 24 year project.

Good Energy, a small alternative energy company, retail the renewable electricity from the solar park to local consumers, with priority supply to Westmill Solar Cooperative members.

<i>Ownership:</i>	<i>Community Owned Cooperative</i>
<i>Capacity:</i>	<i>5MWp</i>
<i>Solar panels:</i>	<i>21,000 solar panels</i>
<i>Annual Output:</i>	<i>4.8GWh pa</i>
<i>Annual saving:</i>	<i>2,400 tonnes CO_{2-e} (based on UK grid emissions)</i> <i>5,100 tonnes CO_{2-e} (based on NSW grid emissions)</i>

2.

3.

4.

5.

6.

COMMUNITY RENEWABLE ENERGY

HEPBURN WIND – HEPBURN WIND PROJECT, LEONARDS HILL, NEAR DAYLESFORD, VICTORIA, AUSTRALIA

Hepburn Wind community cooperative was the first cooperative to build and own wind turbines in Australia.

Hepburn Wind is the trading name of Hepburn Community Wind Park Cooperative Ltd, a cooperative registered in Victoria. It has now 2,000 members, each with one vote. A proportion of the profits are invested in local community environmental initiatives through the Hepburn Wind Community Fund. There have been three rounds of grants since the wind farm was commissioned in 2011 and the volunteer committee distributed \$40,000 to 14 projects in 2013.

Hepburn Wind project is a 4.1MW wind farm consisting of two wind turbines, each rated at 2.05MW with a hub height of 68m. The site is located 10km south of Daylesford and generates enough renewable electricity to supply 2,400 homes, all of Daylesford and most of Hepburn..

The share offer was launched in 2008 and over 1,700 members subscribed a total of \$9 million. The project secured over \$13.1 million in funding with the additional funds coming from bank debt and Government grants. The number of members has increased since 2008 which has reduced the bank debt. Shares have been issued with priority to the local residents of Daylesford and Hepburn Springs.

All profits derived from electricity generation are paid back to the shareholders. The annual cash flow per share is forecast to be 4.6%, 6.3%, 9.5%, 10.3% and 10.8% for Years 1 to 5, respectively, with 12.2% for Years 6 to 10 thereafter. Distributions per share will generally be lower than cash flow per share as some earnings may be retained. The terms of the debt finance include a 3 year period of interest only payments followed by a 7 year period where principal and interest are repaid.

FIGURE 91: HEPBURN WIND – HEPBURN WIND PROJECT, LEONARDS HILL, NEAR DAYLESFORD, VICTORIA, AUSTRALIA
SOURCE: WIND IN THE BUSH



<i>Ownership:</i>	<i>Community Owned Cooperative</i>
<i>Capacity:</i>	<i>4.1MW</i>
<i>Optimal Wind speeds:</i>	<i>3m/s to 25m/s</i>
<i>Annual Output:</i>	<i>12.2GWh pa</i>
<i>Annual saving:</i>	<i>16,225 tonnes CO_{2-e} (based on Victoria emissions) 12,935 tonnes CO_{2-e} (based on NSW grid emissions)</i>

1 RENEWABLE ENERGY RESOURCES

2 RE-THINKING RENEWABLE ENERGY

3 RENEWABLE ENERGY FOR THE CITY OF SYDNEY

4 PERFORMANCE MEASURES

5 ENABLING THE MASTER PLAN

6 CASE STUDIES

1.

COMMUNITY RENEWABLE ENERGY

JÜHNDE BIOENERGY VILLAGE – RENEWABLE GAS FUELLED COGENERATION COOPERATIVE, LOWER SAXONY, GERMANY

In Germany, 65% of renewable energy generation, some 35,000MW, is owned by the customers themselves either as individuals or as cooperatives. There are more than 7,600 cooperatives in Germany and every fourth citizen (21 million people) is a member of a cooperative. Worldwide more than 800 million people in 100 countries are members of cooperatives.

The idea for a “bioenergy village” came from scientists at the University of Göttingen, and the project was implemented with funding support from the German government. The concept is based on the use of renewable energy sources in rural areas using biomass from local agriculture and forestry in a renewable gas fuelled cogeneration plant to supply the complete energy demands of a village, as electricity and community heating.

These villages tend to be self-powered and independent from external grids, although surplus energy is exported over the electricity grid to other nearby consumers. The term “bioenergy village” describes only the energy dependency on biological material, whereas “eco villages” includes other technologies such as wind and solar energy.

Founded in 950 AD, Jühnde became Germany’s first bioenergy village becoming self-sufficient in energy in 2005 based on local renewable gas fuelled cogeneration. Since then more than 200 villages throughout Germany have adopted the Jühnde model.

The village of Jühnde comprises 750 inhabitants, 200 buildings, 9 farmers, 500 cows, 150 pigs, and 1,300 hectares of fields and 800 hectares of wood. In 2002, the Jühnde Bioenergy Village cooperative was founded and established membership contracts with some 70% of the Jühnde inhabitants. The cooperative decided collectively on the restructuring of their energy supply system and built up a self-managed production and distribution infrastructure. The village implemented the bioenergy system, the community heating grid and an operating cooperative to manage the system.

There are 195 members of the cooperative who each paid €1,500 (\$2,250) to become a member with voting rights. Members comprised heat supply customers, farmers, other village people and sponsors. In addition, heat supply customers invested money to connect to the community heating network. There are currently 145 heat contracts. The Board of Directors comprises two executive directors and the Supervisory Board comprises 8 directors. Four people are employed by the cooperative to run the energy system.

FIGURE 92: JÜHNDE BIOENERGY VILLAGE – RENEWABLE GAS FUELLED COGENERATION COOPERATIVE, LOWER SAXONY, GERMANY
SOURCE: BIENERGY VILLAGE/CYCLIFIER



Jühnde Bioenergy Village project comprises a 712kW cogeneration gas engine supplying electricity into the local electricity distribution network and heat into a 5.5km community heating pipe network connecting 145 buildings. The renewable gas supplying the gas engine is biogas generated by a 3,000m³ anaerobic digester. The feedstock for the anaerobic digester is 9,000m³/year of liquid manure co-digested with 15,000 tonnes/year of silage and grass. The system is also provided with a 550kWth peak load biomass boiler for high heat demands in winter and two thermal stores, each storing 50m³ of hot water. The feedstock for the biomass boiler is 350 tonnes/year of wood chips.

The digestate from the anaerobic digester is dried and conditioned into an organic fertiliser and used by the farmers supplying the cooperative. The use of the fertiliser has enabled the farmers to reduce fertilisers by 25% and herbicides and insecticides by around 33%.

A wide diversity of crops and even weeds are used together with liquid manure from cattle and pigs from six animal farms. For biomass production intercropping and double cropping are applied in order to stabilize the agricultural ecosystem.

2.

3.

4.

5.

6.

1 RENEWABLE ENERGY RESOURCES

2 RE-THINKING RENEWABLE ENERGY

3 RENEWABLE ENERGY FOR THE CITY OF SYDNEY

4 PERFORMANCE MEASURES

5 ENABLING THE MASTER PLAN

6 CASE STUDIES

COMMUNITY RENEWABLE ENERGY

The cogeneration network generates twice the amount of electricity than Jühnde consumes and about 100% of the thermal energy requirements of the connected buildings. Approximately 10% of the heat generated is used for the thermophilic process of the anaerobic digester to provide a pathogen free digestate/fertiliser as well as generating more biogas through the thermophilic process.

Members receive a share of the profits of the cooperative. The village makes about €1.1 million (\$1.65 million) a year by selling electricity into the local electricity distribution network. In addition, members who are also customers connected to the community heating network have reduced their heating bills by 30% compared with the previous individual heating oil systems, representing about €900 (\$1,350) savings a year in their heating bills. Savings in heating bills alone have already repaid their membership investment in the cooperative. This compares with a 92% increase in heating oil and 15% increase in fossil fuel natural gas prices over the same period.

The 9 farmers supplying feedstock to the plant receive €350,000 (\$525,000) a year in income from the project so both farmers and village residents benefit from the cooperative both as prosumers/consumers as well as members. Taken together, the economic value to the Jühnde community of 750 inhabitants is about €1.6 million (\$2.4 million) a year.

The cogeneration network displaces 400,000 litres of fuel oil a year and reduces the greenhouse gas emissions of the village by 60%.

FIGURE 93: JÜHNDE BIOENERGY VILLAGE – RENEWABLE GAS FUELLED COGENERATION SCHEMATIC
SOURCE: NATURE.COM

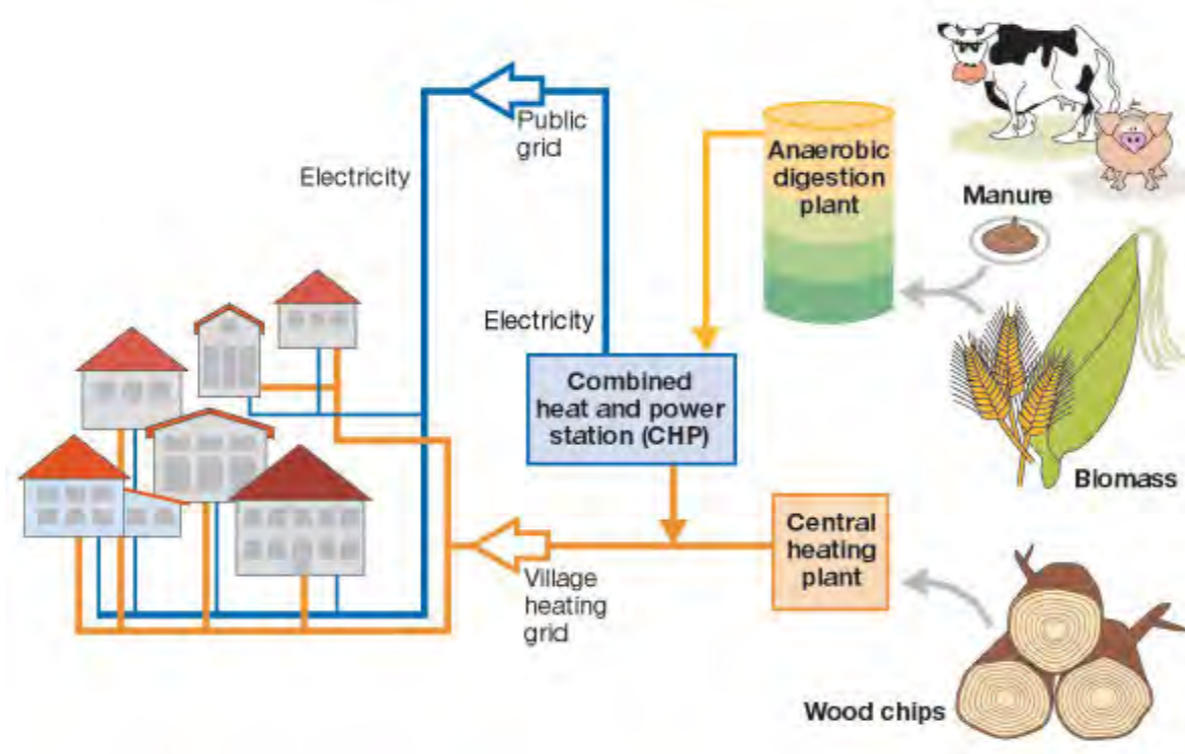

<i>Ownership:</i>	Community Owned Cooperative
<i>Feedstock:</i>	9,000m ³ liquid manure, 15,000 tonnes silage and grass and 350 tonnes of wood chips a year.
<i>CHP Capacity:</i>	700kW electricity 750kW heat
<i>Peak Boiler:</i>	550kWth
<i>Annual Output:</i>	5,000MWh pa electricity 6,500MWh pa heating
<i>Fuel storage:</i>	4,400m ³ storage tank
<i>Annual saving:</i>	3,300 tonnes CO _{2-e} (based on Germany grid emissions) 5,740 tonnes CO _{2-e} (based on NSW grid emissions)

1.

COMMUNITY RENEWABLE ENERGY

BIOGAS RONNENBURG (BIRO) – RENEWABLE GAS GRID INJECTION FARMER'S COOPERATIVE, RONNENBURG, LOWER SAXONY, GERMANY

Founded in the 13th century, Ronnenburg is 8km south-west of Hannover. Five farmers from the area of Ronnenburg, who have been working together for some time in a machine cooperative, jointly established Biogas Ronnenburg GmbH or "BiRo" for short. In 2007, each farmer made an equal contribution of 20% towards the investment costs and substrate supply with annual contracts with additional farmers on the growing of maize substrate. The harvest is organised by BiRo, procurement and settlement is carried out via weighing scales at the biogas facility and silage is billed on site. Harvest and transport is invoiced to the growers.

The biogas facility runs on maize and wheat grain substrate. Fertiliser from the biogas facility is used on the fields in the immediate vicinity.

The farmers produce maize silage on their fields, store it in their own biogas facility and generate raw biogas. Operations at the biogas facility are undertaken by the five farmers. As the farmers own 100% of both the agricultural land and the biogas facility, they earn their money either during substrate growing and/or biogas selling.

The raw biogas is sold to Stadtwerke Hannover, owned by the City of Hannover, who upgrade the biogas to biomethane or substitute natural gas on site and inject the renewable gas into the gas grid to supply the cogeneration plants supplying Hannover's decentralised energy network. Ronnenburg is one of four renewable gas grid injection plants that supply the Hannover decentralised energy network.

The biogas facility consists of two 26m diameter anaerobic digesters, a downstream anaerobic digester and end storage, both with a diameter of 30m. Approximately, 60 tonnes of maize silage and 2 tonnes of wheat substrate are fed into two solid matter entries per day. The biogas facility generates 650m³ of raw biogas per hour with a methane content of 52%.

The carbon dioxide CO₂ is removed from the raw biogas in the processing plant and condensed to 8 bar and flooded in a washing column in counter flow with the washing agent. At the end of the column, biomethane is extracted with approximately 91% methane. The biomethane is subsequently condensed with air in order to achieve the heating value of natural gas in the gas grid. Hydrogen sulphide H₂S is removed by active carbon filters and natural gas odorant added before injecting into the gas grid as a substitute natural gas. The washing liquid is regenerated with a temperature increase and relaxation to ambient pressure and is again available for the washing process. The process is continuous with the throughput of 650m³ of raw biogas converted into 350m³ of methane rich biomethane or substitute natural gas roughly in proportion to the increase of the methane content.

FIGURE 94: RENEWABLE GAS GRID INJECTION FACILITY AT RONNENBURG, LOWER SAXONY, GERMANY

SOURCE: DENA



<i>Ownership:</i>	<i>Farmer's Cooperative</i>
<i>Feedstock:</i>	<i>21,000 tonnes maize substrate and 700 tonnes wheat substrate a year.</i>
<i>Gas Grid Injection Capacity:</i>	<i>350m³/hour (3.3MW)</i>
<i>Annual Gas Grid Injection:</i>	<i>17.5GWh or 63,000GJ</i>
<i>Annual saving:</i>	<i>3,880 tonnes CO_{2-e}</i>

2.

3.

4.

5.

6.

COMMUNITY RENEWABLE ENERGY

CALIFORNIA SOLAR INITIATIVE – THIRD PARTY OWNERSHIP, CALIFORNIA, USA

In 2007, Governor Schwarzenegger signed into law his Million Solar Roofs Plan State Bill 1 and California began a \$3.3 billion ratepayer-funded program to install 3,000MWp of new solar by 2017 and to transform the market for solar energy by reducing the cost of solar generating equipment. The Plan is marketed as ‘Go Solar California’ by State Government. The California Public Utilities Commission’s portion of the program is known as the California Solar Initiative (CSI) which has a target to install 1,940MWp of solar capacity by the end of 2016. The budget for the CSI is \$2,367 million.

Other parts of the ‘Go Solar California’ plan comprise New Solar Homes Partnership, Single-family Affordable Solar Homes, Multi-family Affordable Solar Housing and Research, Development, Deployment and Demonstration (RD&D) programs.

By the end of the first quarter of 2013, California had installed 1,629MWp of solar capacity behind the meter at 167,878 customer sites of which 1,280MWp (66% of CSI target) had been installed under the CSI and 369MWp (19% of CSI target) was in contract under the CSI. A record 391MWp was installed in 2012 and at the current rate of installation the CSI target is likely to be met by early 2014, two years early.

The CSI had also reduced solar generating equipment costs. Since 2007, the average cost of residential systems had decreased by 32% from \$8.77/watt to \$5.98/watt, taking account of inflation. This compares with a 33% reduction in costs for the non-residential sector (\$8.23 down to \$5.55).

The CSI has also led to an explosion of third party ownership of solar PV systems from 10% of the market in 2007 to 75% of the market in 2012. Third party owned solar systems now represent 74% of the market, up from 56% in 2011. The primary reason for the surge in third party ownership is that homeowners want the \$0 down payments and financial savings from Day 1.

The third party ownership model allows homeowners to contract with third party ownership companies, solar leasing companies or solar finance companies to have solar PV systems installed on their rooftops. The companies are responsible for financing, permitting, designing, installing and maintaining the system. Contracts between the homeowners and companies are typically structured around a power purchase agreement or leasing option. Both models normally offer a buyout option allowing homeowners to eventually purchase and own their solar PV systems.

FIGURE 95: CALIFORNIA SOLAR INITIATIVE – GO SOLAR CALIFORNIA, USA

SOURCE: CENTRE FOR SUSTAINABILITY CALIFORNIA



There are four main companies offering solar leasing or power purchase agreements in California – SolarCity, SunRun, Sungevity and SunPower:

	SolarCity	SunRun	Sungevity	SunPower
Contract Structure	Purchase Lease PPA	Lease PPA	Lease PPA	Purchase Lease PPA
Duration of Lease	20 years	20 years	10–20 years	10–20 years
Brand of Solar Panels	Sanyo Kyocera Suntech	Depends on installer	Depends on installer	SunPower

For both solar leasing and power purchase agreements, there is no upfront payment. Solar leases are normally over 10–20 years and a typical homeowner saves about 15% (about \$35 a month) against their previous electricity bill. The solar leasing company takes all tax incentives to help fund the solar PV installations.

<i>Ownership:</i>	<i>Third Party Ownership</i>
<i>Capacity:</i>	<i>1,671MWp</i>
<i>Solar panels:</i>	<i>11,958,335 solar panels</i>
<i>Annual Output:</i>	<i>2,620GWh pa</i>
<i>Annual saving:</i>	<i>1,726,580 tonnes CO_{2-e} (based on California grid emissions)</i> <i>2,777,200 tonnes CO_{2-e} (based on NSW grid emissions)</i>

1 RENEWABLE ENERGY RESOURCES

2 RE-THINKING RENEWABLE ENERGY

3 RENEWABLE ENERGY FOR THE CITY OF SYDNEY

4 PERFORMANCE MEASURES

5 ENABLING THE MASTER PLAN

6 CASE STUDIES

COMMUNITY RENEWABLE ENERGY

GRAZ SOLAR THERMAL DECENTRALISED ENERGY – ENERGY SERVICES MODEL, CITY OF GRAZ, AUSTRIA

With a population of 270,000, Graz is Austria's second largest city. Together with surrounding communities, the population increases to 405,000 with the Graz city/region. Graz is the provincial capital of Styria and was founded in 1128, although its first residents settled about 5,000 years ago between the River Mur and the Schlossberg, a steep rock located in the heart of the city. The inner city centre was declared a UNESCO World Heritage site in 2001.

Graz is served by a city-wide decentralised energy or district heating network supplied by two large gas fired 832MWe cogeneration plants for winter operation located 20km from the city centre, one gas fired 30MWe cogeneration and one 250MWh gas fired boiler plants in the city for summer operation and waste heat from a local steelworks all year round.

The decision to implement a decentralised energy network in Graz was taken following a referendum in 1978 to shut down the local Zwentendorf nuclear power plant. The first cogeneration plant at Mellach, rated at 246MWe, became operational in 1986. The decentralised energy/district heating network is 270km long and covers 26% of the city. By 2010, district heating represented 36% (2,800PJ), oil 22%, electricity 20%, natural gas 15%, coal 2% and renewable energy 5% of the city's energy supply.

In 2007, the City of Graz published its "I Live Graz" project, 7 + 1 indicators necessary for achieving a Smart City in the fields of Economy, Society, Mobility, Energy, Facility Management (supply and disposal) and in the action field of Urban Planning, strategies for the future urban development of Graz towards a "zero emission" city. Two primary targets were established:

- By 2020, Graz would be established as a "Smart City innovation technology and service centre" with an international vocation and evolving into one of the top-ten medium sized European cities. Implementation of Smart City strategies to be implemented in Graz Mitte (Graz City Centre), the first Smart City urban quarter.
- By 2050, Graz would become a dynamic, prosperous and leading medium sized European city, in which the highest quality of life has been achieved. Key to the Smart City strategy was the delivery of a Zero Emissions city where 100% of the total energy required by the city was produced by local renewable energy sources.

The City of Graz was also investing €19 million (\$28.5 million) to reduce energy consumption and greenhouse gas emissions in its own buildings by 30% by 2020 through a range of measures, including building energy efficiency retrofits, implementation of a sustainable energy action plan and increasing the amount of renewable energy as part of its Municipal Energy and Climate Action Plan Graz 2020. Other measures in the Plan include the expansion of the decentralised energy network and energy efficiency in the residential and transport sectors.

Graz Energie is a municipal owned utility responsible for distributing 70% of the city's electricity, together with district heating, gas and water. Two other utilities distribute the remaining 30% of electricity. The Graz Energy Agency was established in 1997 to promote energy efficiency and renewable energies and the new organisational and funding models necessary to deliver the City's Energy and Climate Change Plan. The Graz Energy Agency is owned by:

- City of Graz (47.5%)
- Graz Energie (47.5%)
- Steierische Ferngas (the regional gas transmission company) (5%).

The City of Graz plan for thermal energy is to deliver a 100% renewable system by 2050, as follows:

District Heating	2010	2050
Fossil Fuels	60%	0%
Waste Heat	35%	50%
Solar Thermal	5%	50%

To deliver this target will require 85,000–95,000m² of solar thermal collector arrays by 2050.

Other actions are also being taken such as utilising the city's wastewater to generate renewable energy, renewable gas grid injection to replace fossil natural gas supplying the cogeneration/boiler plants and solar and wind power.

The Graz Energy Agency was responsible for developing and procuring the energy services model using Energy Services Companies or ESCOs for large scale solar thermal projects injecting renewable heat into the decentralised energy/district heating network. German ESCO S.O.L.I.D was successful in developing four large scale solar thermal projects at Graz based on a design, finance, build, operate and maintain model. S.O.L.I.D partnered with Graz energy services provider nahwaerme. at Energiecontracting GmbH who owns the projects. Projects implemented at Graz on the energy services model are:

Project	Operational	Solar Area (m ²)	Solar Heat Generation (MWh pa)	Emissions Reduction (tonnes pa)
UPC Arena	2002	1,407	582	1,900
Berliner Ring	2003	2,417	1,000	3,265
AEVG	2007	3,556	1,600	4,800
Wasserwerk Andritz	2009	3,855	1,619	5,205
Total		11,235	4,801	15,170

COMMUNITY RENEWABLE ENERGY

Each solar thermal project comprises high efficiency non-concentrating solar collectors able to supply hot water up to 120°C. The district heating network flow temperature is also up to 120°C and this temperature will also supply thermal cooling via heat fired absorption chillers.

Each solar thermal system is connected to the district heating network via a buffer station. Some systems are mounted on the rooftops of occupied buildings, such as Berliner Ring, with the surplus solar heat exported into the district heating network. Other systems are mounted on industrial buildings, such as the AEVG, or ground mounted, such as Wasserwerk Andritz where most, if not all of the solar heat is exported into the district heating network.

The capital cost of the four projects was €5.1 million (\$7.65 million) and heat is sold to consumers via Graz Energie for the same price as fossil fuel heat under an Energy Performance Contract with the ESCO.

FIGURE 96: ABFALL-ENTSORGUNGS-UND VERWERTUNGS (AEVG) WASTE COLLECTION SITE SOLAR THERMAL PLANTS, GRAZ, AUSTRIA
SOURCE: SOLAR THERMAL WORLD



<i>Ownership:</i>	<i>Energy Services Model</i>
<i>Capacity:</i>	<i>15MWth</i>
<i>Annual Output:</i>	<i>4,801MWh pa</i>
<i>Solar panels:</i>	<i>11,235m²</i>
<i>Thermal Storage:</i>	<i>125m³ solar storage + 9,500m³ district heating storage</i>
<i>Annual saving:</i>	<i>15,170 tonnes CO_{2-e} (replacing natural gas)</i>

1 RENEWABLE ENERGY RESOURCES

2 RE-THINKING RENEWABLE ENERGY

3 RENEWABLE ENERGY FOR THE CITY OF SYDNEY

4 PERFORMANCE MEASURES

5 ENABLING THE MASTER PLAN

6 CASE STUDIES

1.

COMMUNITY RENEWABLE ENERGY

TRIMONT AREA WIND FARM – LANDOWNER POOL, TRIMONT, MINNESOTA, USA

Minnesota is the 12th largest and 21st most populous state of the United States of America. Nearly 60% of its residents live in the Minneapolis-Saint Paul metropolitan area (known as the twin cities). The large majority of residents are of Scandinavian and German descent and the state is well-known as a centre of Scandinavian American culture. The state ranks amongst the healthiest states and has a highly literate population with a high rate of civic participation and voter turnout.

Community wind is one of the fastest growing markets in the USA with 27 states having legislation that allows community renewable energy schemes. Today, there are more than 1,500 wind farms owned by farmers, ranchers, landowners, consumer-owned utilities, school districts, universities and native tribes. With 469 operational projects, Minnesota has the largest concentration of community owned wind farms in the USA.

Landowner wind associations are a distinctive type of community owned renewable energy where several landowners with adjacent land procure the wind farm project as a group of landowners rather than utilities “picking off” individual landowners one at a time, which may result in a checkerboard of wind leases with competing developers and poor siting of wind turbines. Landowner pool cooperatives were developed out of a mistrust of energy developers without ties to the local community, concern over the local community lack of knowledge giving energy developers unfair advantages during negotiations and landowners previously burned by predatory industrial contracts.

As a cooperative, the landowner pools can address controversy and division in the community with the credibility of fellow residents. As a group, landowners can assess the value of their bundled wind resource and as members of the community they have an incentive to negotiate tangible benefits to the community itself. They can also seek out expertise to help them make informed decisions and they can negotiate with energy developers from a position of strength.

The landowner wind association model also benefits genuine renewable energy developers through minimising costs, time and other resources in trying to negotiate and permit individual projects with individual landowners and this is often reflected in the better deals that landowner wind associations can deliver for their members and the community.

In 2003, a group of farm families from Trimont, sought business advice to see if they, as a group of landowners, could become entrepreneurs and develop their own wind farm. It turned out that they could and with the help of their business adviser and others they developed the Trimont Area Wind Farm cooperative and in 2005, built the first commercial-scale wind farm developed by landowners in the USA.

Connection to the grid and a power purchase agreement were contracted with Great River Energy, the local electricity generation and transmission cooperative, who in turn contracted PPM Energy to construct and operate the wind farm. The negotiated grid connection and power purchase agreement secured the finance for the project.

The Trimont Area Wind Farm, 17 miles (27km) north of the City of Jackson, is the largest landowner-developed wind farm in the USA. Situated on approximately 8,900 acres (3,595 hectares) the wind farm generates enough renewable electricity to supply 29,000 Minnesota homes. The 101MW wind farm consists of 67 wind turbines, each rated at 1.5MW with a hub height of 100m.

The landowner pool comprises 43 landowners who partnered with PPM Energy and Great River Energy to develop the project, which will help Great River Energy meet the Minnesota Renewable Energy Objective, calling on electric utilities to produce 10% of their energy from renewable sources by 2015, and 25% by 2025. The land continues to be owned and farmed by local landowners and energy customers throughout the state benefit from the wind energy produced at the Trimont Area Wind Farm.

The project generates more than \$1 million a year in local economic benefit to the Trimont area in the form of taxes, easement payments, landowner revenue participation payments and jobs.

Great River Energy is a “Not-For-Profit” generation and transmission cooperative supplying electricity to 28 distribution cooperatives in Minnesota, North Dakota and Wisconsin. It owns and operates 4,600 miles (7,405km) of transmission lines and generates more than 3,500MW of electricity from a diverse mix of fossil fuel and renewable energy generation.

It is the second largest electricity supplier in the state of Minnesota and the fourth largest cooperative of its type in the USA. The 28 member cooperatives distribute electricity to more than 650,000 member consumers, over 1.7 million residents. Like other cooperatives, Great River Energy exists to serve its membership. It is member-controlled and governed by a democratically elected board of directors who are electricity cooperative members themselves. Board members establish rates and develop policies in the best interest of Great River Energy and its members.

PPM Energy was owned by Scottish Power at the time of the construction of Trimont Area Wind Farm but Scottish Power was taken over by Spanish energy company Iberdrola in 2007, effectively becoming Europe’s third largest utility. PPM Energy now forms part of Iberdrola Renewables who own 14,101MW of renewable energy worldwide.

2.

3.

4.

5.

6.

COMMUNITY RENEWABLE ENERGY

In 2008, the Trimont Area Wind Farm cooperative increased to 56 members and developed a second wind farm at Elm Creek which is adjacent to the Trimont Area wind farm. This 99MW wind farm consisting of 66 wind turbines, each rated at 1.5MW with a hub height of 80m, generates enough renewable electricity to supply a further 29,000 Minnesota homes, ie, 58,000 homes in total for both wind farms.

In 2013, the Trimont Area Wind Farm cooperative developed a third wind farm at Elm Creek II which is adjacent to the Elm Creek I wind farm. This 149MW wind farm consisting of 62 wind turbines, each rated at 2.4MW with a hub height of 80m, generates enough renewable electricity to supply a further 40,000 Minnesota homes, ie, 98,000 homes in total for all three wind farms.

The Trimont and Elm Creek wind farms together provides more than \$3.2 million a year in local landowner payments, generating in total, \$4.7 million a year in local economic benefit to the Trimont area, in the form of taxes, easement payments, landowner revenue participation payments and jobs.

FIGURE 97: TRIMONT AREA WIND FARM, TRIMONT, MINNESOTA, USA
SOURCE: CITY OF JACKSON



<i>Ownership:</i>	<i>Landowner Pool</i>
<i>Capacity:</i>	<i>359MW (Trimont Area, Elm Creek I & II wind farms)</i>
<i>Optimal Wind speeds:</i>	<i>3.5m/s to 25m/s</i>
<i>Annual Output:</i>	<i>892GWh pa</i>
<i>Annual saving:</i>	<i>1,034,915 tonnes CO_{2-e} (based on Minnesota grid emissions)</i> <i>945,700 tonnes CO_{2-e} (based on NSW grid emissions)</i>

1 RENEWABLE ENERGY RESOURCES

2 RE-THINKING RENEWABLE ENERGY

3 RENEWABLE ENERGY FOR THE CITY OF SYDNEY

4 PERFORMANCE MEASURES

5 ENABLING THE MASTER PLAN

6 CASE STUDIES

1.

COMMUNITY RENEWABLE ENERGY

HAMBURG ENERGIE – MUNICIPAL OWNED RENEWABLE ENERGY, HAMBURG, GERMANY

Hamburg (Free and Hanseatic City of Hamburg), is the second largest city in Germany and the eighth largest city in the European Union. The population of the City of Hamburg is 1.8 million people, while the Hamburg Metropolitan Region has a population of 5 million inhabitants. Hamburg was founded by the Emperor Charlemagne with the building of a castle in AD 808. The official name reflects its history as a member of the medieval Hanseatic League, as a free imperial city of the Holy Roman Empire, and that it is a city-state, and one of the 16 states of Germany. Before the 1871 Unification of Germany, it was a fully sovereign state, and prior to 1919, the stringent civic republic was ruled by a class of burghers or Hanseatan.

As Europe's second largest port, the City is well aware of climate change and the threat to the future of the City of Hamburg, for the health and safety of its people, for the economic and social structure and for the natural spaces and wildlife of the metropolitan region. In common with the rest of Germany, the City's climate change target is to comply with the Energiewende (Energy Transition or Energy Turnaround) which is to reduce greenhouse gas emissions by 40% by 2020 and by 80–95% by 2050 below 1990 levels. The Energiewende target for energy is to phase out nuclear energy by 2020 and to supply 33% of its electricity from renewable energy by 2020, at least 50% by 2030 and 80% by 2050.

By the end of 2012, Germany had reduced its carbon emissions by 25.5% from 1990 levels thereby overshooting its Kyoto Protocol target of 21% reduction by 2012. Germany had also shut down 8 nuclear plants (8.4GW capacity) in 2011 and generated nearly 25% of Germany's electricity requirements from renewable sources exceeding its 20% renewable energy target by 2020, eight years early.

However, more than 50% of energy generation and more than 65% of renewable energy generation, some 35,000MW, are owned by the customers themselves either as individuals, cooperatives or as municipalities. The rapid rise in decentralised energy has had a dramatic impact on centralised energy companies. In 2008, the top 20 European energy utilities were worth €1 trillion (\$1.3 trillion) but by 2013 they are worth less than half of their 2008 value, a loss of €500 billion (\$650 billion) in 5 years. The collapse in the centralised energy business model has caused some of Europe's largest energy companies to redevelop their business model as energy services companies enabling prosumers rather than as energy companies supplying consumers.

To support Energiewende, the Hamburg Climate Action Plan 2007–2012 set out 13 goals for sustainable climate action including a carbon free, or at least low carbon electricity and heating produced from a steadily increasing share of renewable energy, energy savings from industry, transport and buildings, increase in renewable energy and cogeneration/trigeneration, sustainable mobility, climate change adaptation and communication of climate change. The Climate Change Action Plan reduced carbon emissions by 2 million tonnes at a cost of €100 million (\$150 million) over 5 years. The 5 year Climate Change Action Plan was replaced by the Climate Protection Master Plan in 2013 with even more accelerated targets for the next 5 years.

Prior to 1997, the electricity, gas and decentralised energy or district heating grids were owned by the City of Hamburg but between 1997 and 2002 the grids were privatised and sold to major European energy companies. However, following dissatisfaction with increasing energy prices, the public's growing opposition to coal and nuclear fired power plants which mainly supplied Hamburg and the private energy supplier's failure to install any meaningful renewable energy capacity led to the City in 2008, deciding to establish its own community energy supplier.

To support this activity, the City also established IBA Hamburg as a 100% municipal owned development company, with a €100 million budget to catalyse and enable the implementation of private investment or, in some cases, public funding, for innovative social, technological, cultural or energy efficiency schemes. By 2013, IBA Hamburg had generated private sector investment of €625 million and public spending of €200 million in more than 60 projects. IBA Hamburg works with both Hamburg Energie and private renewable energy developers.

Hamburg Energie was established in 2009 as a 100% municipal owned energy company supplying renewable energy and gas to Hamburg consumers. Initially, renewable electricity and gas (partially renewable) was purchased in the market but by the end of 2009 Hamburg Energie had built its first large scale solar PV project, acquired 25.1% each of the local electricity, gas and district heating grids and established Hamburg Energie Solar to assist Hamburg residents and businesses to install their own solar projects. Investment into rooftop solar PV was €24 million (\$36 million AUD) with 15% equity and 85% debt finance for the first 10MWp of solar PV. Equity of €4 million (\$6 million AUD) was provided by Hamburger citizens in the form of a solar bond issue by the City of Hamburg.

By 2012, Hamburg Energie had become the second largest energy supplier in the city with more than 90,000 customers. It had also initiated 36 cogeneration/ trigeneration decentralised energy networks reducing greenhouse gas emissions by 41,500 tonnes a year. Hamburg Energie's key target is to supply 50% of the sold electricity from its own renewable energy plant within 5 years which is sold under the logo of 'OK Power'.

The City's proactive approach to municipal owned renewable energy has high public support and during the German 2013 Federal election Hamburg electors voted in a referendum for the City of Hamburg to remunicipalise the electricity, gas and district heating grids despite a well-funded campaign from private utilities and others for a no vote. Key factors in the yes vote was the desire to reduce energy costs, increase renewable energy and the fact that the private utilities generated electricity from predominantly coal and nuclear power plants. As the private utilities refused to sell their shares in the local grids valued at €2 billion (\$3 billion) Hamburg Energie will bid for the 20 year concession rights in the upcoming tenders for electricity in 2014 and for gas in 2016.

More than 170 German municipalities have set up their own energy utilities since 2007 and more than 200 local grid concessions have already been acquired by the new municipal utilities but Hamburg is the largest city to do this so far. Local energy costs are typically 16.6 euro cents per kWh compared with 27 euro cents per kWh for household customers in Germany.

Cities that did not privatise their energy grids, such as Frankfurt and Munich, are now showing the value of keeping energy supply in municipal hands. Both major German cities also have 100% renewable energy targets.

2.

3.

4.

5.

6.

COMMUNITY RENEWABLE ENERGY

Since local grid network charges were the largest components in energy bills, City analysts had calculated that if profits in the local grids were reduced by 50% and the remaining profits recycled into building renewable energy, consumers energy bills could be reduced at the same time as making renewable energy more economical and therefore, accelerating the uptake of local renewable energy.

By 2013, Hamburg Energie had completed the following renewable energy projects:

Project	Operational	Capacity (MW)	Production (MWh pa)	CO _{2-e} Savings (Tonnes pa)
Georgswerder Solar PV	2009	0.5	425	210
Obergeorgswerder Deich Windmill	2010	1.5	3,485	1,740
Windparc Dradenau Windmills	2010	5.0	11,615	5,810
Hamburg Wasser Biogas CHP & Renewable Gas Grid Injection	2011	2.4	5,600	4,300
Georgswerder – Repower Windmill	2012	3.4	7,900	3,950
Hamburg Energie Solar	2012	12.0	10,500	5,040
Energiebunker Solar, Biomass & Biogas CHP	2013	8.1	25,500	6,600
Total		32.9	65,025	27,650

Equalling the height of the wind turbines on Georgswerder “Energy Hill” the Energiebunker represents the visible renewable energy vision of the City of Hamburg. A tourist destination with a museum/exhibition centre, elevated café and a cantilevered platform, which runs around the whole building at a height of 30m, offers 360° views over almost the whole of Hamburg.

Built in 1943, the former World War 2 air raid shelter has been transformed into the iconic Energiebunker renewable energy power plant supplying renewable electricity and heating to the Reiherstieg neighbourhood as part of the Wilhelmsburg quarter that will eventually supply renewable electricity and heating to 55,000 residents. The interior of the building was completely destroyed by the British Army in 1947 leaving the exterior as a derelict war monument for more than 60 years. The Energiebunker comprises a renewable gas fuelled cogeneration plant, biomass plant, 2,000m³ thermal storage, solar PV and solar thermal mounted on the roof and south facing façade of the building.

Hamburg Energie is continuing developing and building other renewable energy projects, including a 10MW deep geothermal energy system at Wilhelmsburg and further renewable gas grid injection projects to replace fossil fuel natural gas in its cogeneration/trigeneration plants.

FIGURE 98: GEORGSWERDER ‘ENERGY HILL’ WIND AND SOLAR FARM, HAMBURG, GERMANY
SOURCE: CITY OF HAMBURG



FIGURE 99: ENERGIEBUNKER RENEWABLE ENERGY PLANT, HAMBURG, GERMANY
SOURCE: IBA HAMBURG



<i>Ownership:</i>	<i>Municipal Owned Renewable Energy</i>
<i>Capacity:</i>	<i>32.9MW</i>
<i>Annual Output:</i>	<i>65GWh pa</i>
<i>Annual saving:</i>	<i>27,650 tonnes CO_{2-e} (based on Germany grid emissions) 45,670 tonnes CO_{2-e} (based on NSW grid emissions)</i>

1 RENEWABLE ENERGY RESOURCES

2 RE-THINKING RENEWABLE ENERGY

3 RENEWABLE ENERGY FOR THE CITY OF SYDNEY

4 PERFORMANCE MEASURES

5 ENABLING THE MASTER PLAN

6 CASE STUDIES

1.

COMMUNITY RENEWABLE ENERGY

CALIFORNIA SHARED RENEWABLE SELF-GENERATION PROGRAM, USA

As renewable energy becomes increasingly cost-competitive with fossil or nuclear fuel electricity sources, more and more Americans are turning to renewable sources to meet their energy needs. Hundreds of thousands of home and business owners across the United States have invested in renewable energy and are generating their own electricity. However, the majority of residential and commercial energy consumers cannot install renewable energy systems on their own property for a number of reasons.

Shared renewable energy programs address this issue by allowing a single renewable energy facility to serve multiple, dispersed energy consumers and enabling these consumers to receive direct financial benefits on their own bill from their investment in renewable energy. Shared renewable energy programs can allow renewable energy developers to tap a market that is currently underserved but potentially huge. For example, if just 5% of US households were to invest in a 5kWp interest in a shared solar system – the size of a typical residential rooftop solar installation in the US – it would result in over 28,000MW of additional solar capacity, equivalent to the output of 50 coal fired power plants.

Currently, Colorado, Connecticut, Delaware, Georgia, Maryland, Massachusetts, Minnesota, New Hampshire, Nebraska, New Jersey, New Mexico, New York, Rhode Island, South Georgia, Washington, Washington DC and now California at the second attempt have enacted or have active State Shared Renewable Energy Programs. To respond to this rapidly expanding new renewable energy market the Interstate Renewable Energy Council published the “Model Rules for Shared Renewable Energy Programs” in 2010 and this is used as a model for the states that have these programs.

California’s first attempt to legislate for a Shared Renewable Energy Program was frustrated by private utilities, political and other vested interests. However, due a backlash from voters the legislation was passed at the second attempt.

In 2013, Governor Brown signed into law SB 43, the California Shared Renewable Self-Generation Program that enables utility customers – local governments, businesses, schools, homeowners and renters to access affordable renewable energy. The Act allows energy utility customers who are incapable of generating their own renewable energy on site using solar PV, wind turbines or other forms of renewable energy generation, to obtain renewable energy from an off-site renewable energy facility. Additionally, the new law removed the regulatory barriers that were deterring schools and local governments from pursuing off-site solar opportunities.

Whilst rooftop solar has been a runaway success for homeowners able to take advantage of the California Solar Initiative, at least 75% of households cannot participate because they are renters and do not own their own roofs, they do not have strong enough credit, or their roofs are too small or do not receive enough sunlight. Similarly, for businesses, 70% of whom rent or lease their facilities.

Despite their inability to utilise renewable energy, these utility customers continue to pay into solar and renewable energy programs that fail to benefit them financially. Additionally, programs designed to benefit low-income households or rental utility customers by providing them the opportunity to utilise renewable energy either have no room for new participants or fail to provide consumers with access to affordable renewable energy. Moreover, programs set up to offer local governments and schools an avenue to invest in off-site renewable energy have proven uneconomical, with too many regulatory barriers preventing projects from being developed.

SB 43 now allows all California households and businesses the ability to voluntarily buy up to 100% renewable energy from a shared facility in their local utility’s area and receive a credit for the generation/supply portion on their utility bill. SB 43 is not limited to solar but applies to any new renewable energy facility up to 20MW in capacity.

The main compromise to enable SB 43 to be passed into law was to implement shared renewable self-generation as a pilot program capped at 600MW of generation by 2020, enough to power 100,000 American homes, after which the California Public Utilities Commission will determine whether the program should be continued or expanded. The program works, as follows;

1. First, a renewable energy developer builds a shared renewable energy plant and signs up investors or subscribers who choose how much electricity they want to offset.
2. Next, the shared renewable energy project generates electricity and sends it to the grid. The volume is then tracked by the utility.
3. Finally, the utility gives an energy bill credit to the investor or subscriber (in \$/kWh), which is then subtracted from their monthly utility bill.

Importantly, customers will be able to purchase up to 100% renewable power with no state subsidies or cost shift to non-participating customers, while creating jobs and reducing greenhouse gas emissions. SB 43 is estimated to provide 6,500 new Californian jobs on top of the 43,000 Californians already employed in the industry. The in-state economic value is estimated to be \$2.65 billion as a result of the 600MW program alone.

2.

3.

4.

5.

6.

COMMUNITY RENEWABLE ENERGY

Allowing customers to invest in a system off-site simplifies the process of selecting renewable energy. These community renewable energy facility arrangements come in many different forms. A congregation could power their homes by sharing the electricity generated by a solar system on their church's roof. A school campus could invest in a portion of a system located at a different school to power their entire campus.

For example, SolarShares offers residents of the City of Sacramento the opportunity to buy shares in its solar farm. The electricity generated by each customer's shares appears as a credit on his or her energy bill. Typically, customers make savings on average of \$4–\$50 a month, depending on the month and sunshine throughout the year. For a monthly fee, participants opt into solar power production. The current phase is sold out, although plans are in progress to expand capacity.

Shared renewable energy generation must be as close as possible to the investors consuming the renewable electricity to avoid or minimise distribution network augmentation and to maximise the embedded benefits of the scheme.

The Vote Solar Initiative estimates that more than 20,000 residential ratepayers will take advantage of the pilot program. In addition, local governments, schools, businesses and the military are likely to take advantage of the new legislation.



<i>Ownership:</i>	<i>State Shared Renewable Energy programs</i>
<i>Capacity:</i>	<i>600MWp</i>
<i>Solar panels:</i>	<i>4,293,035 solar panels</i>
<i>Annual Output:</i>	<i>940GWh pa</i>
<i>Annual saving:</i>	<i>619,960 tonnes CO_{2-e} (based on California grid emissions)</i> <i>997,200 tonnes CO_{2-e} (based on NSW grid emissions)</i>

1 RENEWABLE ENERGY RESOURCES

2 RE-THINKING RENEWABLE ENERGY

3 RENEWABLE ENERGY FOR THE CITY OF SYDNEY

4 PERFORMANCE MEASURES

5 ENABLING THE MASTER PLAN

6 CASE STUDIES

1.

COMMUNITY RENEWABLE ENERGY

ECOTRICITY “ECOBONDS”, UK

Green bonds or climate bonds are bonds that fund clean energy projects that are gaining popularity from China to France to Canada. Green bonds are fixed-income investment products that have been created primarily to boost the development of renewable energy projects and reduce carbon emissions. A growing appetite for green bonds is prompting issuers to release larger volumes in Europe, the USA, Canada and elsewhere, although the product itself is only 6 years old. There are currently \$346 billion held in green bonds mainly to finance very large grid connected renewable energy projects by mainstream utilities.

In 1995, a husband and wife team decided to build their own windmill in Stroud, Gloucestershire but they could not get a fair price for their renewable electricity from their local electricity company which made the project uneconomic. After spending a year studying the electricity market they decided that the only business model that would work was to supply electricity directly to customers on the ‘embedded generation’ model. In April 1996, they formed a ‘not-for-dividend’ company (Ecotricity) and began generating renewable electricity from their first project supplying Cheltenham and Gloucester College from a local landfill gas site. Later that same year they completed their first windmill and it has been generating renewable electricity ever since.

This small company supplied renewable electricity to 209 homes in 1997. By the end of 2013 Ecotricity had built 53 wind turbines, generating 56MW of renewable electricity supplying nearly 90,000 customers. Projects included the iconic wind turbines at Ford Dagenham in the heart of London, Sainsbury’s cold store, the UK’s most visible wind farm at the Prudential Insurance offices at Green Park alongside the M4 motorway and the Michelin tyre factory in Dundee. Until 2005, 90% of the British public had never seen a wind turbine or a wind farm so such projects helped to counteract the anti-wind scaremongering by showing people what modern windmills looked like.

In 2010, Ecotricity started supplying gas with a “no fracking” guarantee as part of their dual fuel offering to compete with companies like British Gas. Ecotricity does not purchase gas from coal seam or shale gas fracking sites and its gas includes a proportion of renewable gas. Ecotricity are developing a number of renewable gas grid injection projects and these may form part of their Ecobond Three offering in 2014.

Ecotricity also launched Electric Highways with Welcome Break motorway service stations providing free top up electricity to electric vehicles travelling along motorways. Since then Ecotricity has installed electric vehicle charging points at Roadchef and Moto Services service stations. Ecotricity now has 89 electric vehicle charging stations along the M1, M4, M5, M6, M25, M40 and M42 as well as at IKEA stores throughout the UK and at various other locations powered by Ecotricity’s own renewable electricity. Electric vehicle owners register for a free swipe card. There are more than 5,700 electric vehicles in the UK with sales increasing rapidly (up 25% in Q3, 2013). The electric car industry has set a target of selling 1.5 million electric cars by 2020.

In 2010, Ecotricity raised £10 million (\$15 million) from their Ecobond One to finance their pipeline of projects ready to be constructed. This effectively replaced the debt finance of projects and enabled projects to proceed which would otherwise not been able to do so because of the high debt finance interest rates from traditional loans. The bond was over-subscribed by almost 50% with 1,800 people applying for the bonds. Applications ranged from £500 (\$750) to £500,000 (\$750,000). This had exceeded the previous largest private bond issue in the UK, £3.6 million (\$5.4 million) raised by Hotel Chocolat earlier in 2010. The bonds pay a fixed rate of return of 7.5% for Ecotricity customers and 7% for non-Ecotricity customers with their capital returned in full at the end of 4 years.

The reason for the good financial offering is that similar to their energy sales, Ecotricity cut out the middle-men in the issuance by offering bonds directly to customers and the general public. The minimum investment was £500 with applicants receiving 80% of the sum they applied for above £500 for Ecotricity customers and 50% for non-Ecotricity customers. As a result £7.2 million (\$10.8 million) of investment came from Ecotricity customers and £2.8 million (\$4.2 million) from the general public. Ecobond One financed a new windmill to power the G24i solar panel factory in Cardiff, a 1MW sun park in Lincolnshire and the third windmill at Ford Dagenham.

In 2011, Ecotricity raised another £10 million from their Ecobond Two. This bond pays a fixed rate of return of 6.5% for Ecotricity customers and 6% for non-Ecotricity customers. Although, slightly lower than Ecobond One the rate of return is against record low interest rates in the UK and is higher than the UK Government’s feed-in tariff of 4.5%. Ecobond Two will finance a pipeline of projects of up to 19 windmills.

Prior to 2010, Ecotricity invested 20% and raised 80% debt finance to fund its projects. The 20% equity is self-financed by Ecotricity but the 80% debt finance attracted hefty interest rates of 13–15% which killed most renewable energy projects in Ecotricity’s project pipeline.

2.

3.

4.

5.

6.

COMMUNITY RENEWABLE ENERGY

However, since 2010, Ecotricity's strategy is to develop renewable energy projects to planning consent stage and then seek finance to replace the 80% debt finance by raising the money through issuing Ecobonds. This allows Ecotricity customers and the general public to make renewable energy projects happen and to receive a good return on investment which is better than they can receive by other investments but about half the cost to Ecotricity than debt finance. Renewable energy projects financed in this way take about 4 years to pay back investors in full from the value of the renewable electricity generated.

Since Ecobond One, Ecotricity has been active in developing a sustainable project pipeline for Ecobond Two and future Ecobonds.

In 2012, the Church of England won a high court battle with the UK Government to install solar PV on its 16,000 church buildings in the UK as part of its target to reduce greenhouse gas emissions by 80% by 2050. Ecotricity was selected by the Church of England for their dedication to people and planet over profit. Ecotricity already supplies 300 CoE churches with wind power. So far, solar PV has been installed on more 150 CoE churches, schools and church halls, but there remains a significant project pipeline for the remaining CoE buildings.

Also in 2012, the Royal Society for the Protection of Birds (RSPB) selected Ecotricity to supply 100% renewable electricity to all 127 of its sites across the UK – encompassing all of its offices, visitor centres and reserves. Climate change poses the single biggest threat to birds and wildlife with a third of land-based species threatened with extinction by 2050 without extensive action to reduce greenhouse gas emissions. The RSPB has commented on over 1,500 wind farm planning applications and opposed only 6% of the applications on wildlife impact grounds.

The RSPB's corporate strategy requires the charity to reduce its greenhouse gas emissions by 3% a year and by 80% by 2050. In order to deliver the RSPB reduction in greenhouse emissions target, the RSPB and Ecotricity submitted a planning application for a wind turbine at its UK headquarters in Sandy, Bedfordshire which would supply two thirds of the RSPB's electricity needs across the UK.

FIGURE 101: FEN FARM SUN PARK, LINCOLNSHIRE, UK (ONE OF THE PROJECTS FUNDED BY ECOBOND ONE)
SOURCE: BEBA ENERGY



<i>Ownership:</i>	<i>Ecobond One</i>
<i>Capacity:</i>	<i>10.2MW</i>
<i>Annual Output:</i>	<i>22GWh pa</i>
<i>Annual saving:</i>	<i>9,840 tonnes CO_{2-e} (based on UK grid emissions)</i> <i>23,370 tonnes CO_{2-e} (based on NSW grid emissions)</i>

1 RENEWABLE ENERGY RESOURCES

2 RE-THINKING RENEWABLE ENERGY

3 RENEWABLE ENERGY FOR THE CITY OF SYDNEY

4 PERFORMANCE MEASURES

5 ENABLING THE MASTER PLAN

6 CASE STUDIES

ENABLING ACTIONS

LONDON PLAN RENEWABLE ENERGY POLICIES

The Greater London Authority (GLA) consists of a directly elected executive Mayor of London and an elected 25-member London Assembly with scrutiny powers. It is a strategic regional authority responsible for the strategic administration of the 1,579km² of Greater London with a population of 8,174,100. It shares local government powers with the councils of 32 London Boroughs and the City of London Corporation.

The GLA is responsible for coordinating and land use planning in Greater London. The Mayor produces a strategic plan, the 'London Plan'. The individual London Borough councils are legally bound to comply with the London Plan and the Mayor has the power to over-ride planning decisions made by the London Boroughs if they are believed to be against the interests of London as a whole.

The London Plan was given greater emphasis with the Greater London Authority Act 2007 which introduced a new statutory duty on the Mayor to prepare and publish climate change mitigation and adaptation strategies. This includes the specific duty to take action to mitigate the effects of climate change and help London adapt to unavoidable impacts. The Mayor's Climate Change Mitigation and Energy Strategy was published in 2011 which confirmed the Mayor's Climate Change Action Plan 2007 key targets to reduce CO_{2-e} emissions by 60% of 1990 levels and to supply 25% of London's energy supply from decentralised energy by 2025.

The revised London Plan 2008 changed the energy hierarchy from an energy led policy to an emissions led policy and placed greater emphasis in the planning process of the GLA on connecting new development proposals to district heating networks and securing site wide networks and on-site CHP where feasible.

Strategic planning applications referable to the Mayor are required to include energy assessments setting out how they will meet the London Plan energy policies. Applicants are required to set out how the CO_{2-e} emissions of the proposed development have been minimised through the application of the energy hierarchy:

Be lean: *use less energy*

Be clean: *supply energy efficiently*

Be green: *use renewable energy*

Each assessment is evaluated by a GLA specialist team to ensure that the key strategic issues are adequately addressed and that the CO_{2-e} reductions have been maximised. The energy hierarchy has the effect of incentivising developers to first reduce emissions through more cost effective energy efficiency measures, then reducing emissions through site-wide or precinct scale cogeneration/trigeneration decentralised energy networks and finally reducing the remaining emissions by 20% from on-site or near-site renewable energy.

The London South Bank University (LSBU) undertook monitoring of the London Plan Energy Policies in the first year of operation of the revised London Plan and analysed 147 applications of about 340 applications referred to the Mayor. The LSBU found that 25% of the sample met or exceeded 20% CO_{2-e} saving from renewable energy technologies, a third of developments achieving between 10% and 20% CO_{2-e} savings and a further 38% achieving up to 10% savings.

FIGURE 102: CONTRIBUTION BY MAIN RENEWABLE ENERGY AND CHP TECHNOLOGIES IN STUDY (147 APPLICATIONS)
(SOURCE: GREATER LONDON AUTHORITY)

Contribution by Main Renewable Energy and CHP Technologies in Study (147 applications)	Biomass boilers	Ground source heating/cooling	Photo-voltaics	Solar thermal	Wind	Gas-fired CHP	Fuel cell CHP	Biomass CHP
number of installations	74	31	55	26	10	94	6	6
tonnes CO _{2-e} saved	11,695	3,351	1,718	560	2,735	25,331	5,575	6,946
MW reported	28.6	5.8	0.9	0	2.6	12.4	3.0	0.3
MW estimated	21.7	8.9	2.1	3.5	0	8.0	0	1.2
MW9 TOTAL (reported and estimated)	50.3	14.7	3.0	3.5	2.6	20.4	3.0	1.5
tonnes CO _{2-e} saved per MW specified	233	228	567	159	1,047	1,239	1,834	4,567
tonnes CO _{2-e} saved per installation	158	108	31	22	274	269	929	1,158

ENABLING ACTIONS

Biomass boilers, photovoltaics, ground source heat pumps and solar thermal were the most popular renewable technologies (in that order). The popularity of photovoltaics had significantly increased from the 2007 study due to its compatibility with CHP. Similarly, with the sudden growth in biomass boilers due to their compatibility with CHP, such as the London 2012 Olympics trigeneration network.

More than half of the planning applications analysed achieved CO_{2-e} savings of at least 30% and approximately a quarter met or exceeded 40% CO_{2-e} savings over and above the 2006 UK Building Regulations through the use of a combination of energy efficiency, CHP and renewable energy measures (including renewable fuelled CHP).

The average CO_{2-e} savings achieved were 33%. This is made up of 14% from energy efficiency measures beyond 2006 Building Regulations baseline, 9% related to the use of gas fired CHP and a further 10% from renewable energy technologies.

The 2010 monitoring of the London Plan Energy Policies showed that the Policies were continuing to reduce emissions over and above the UK Building Regulations. Overall, in 2010 projected CO_{2-e} savings of 71,813 tonnes of CO_{2-e} were secured by the revised London Plan compared to 57,911 tonnes of CO_{2-e} in 2009. In addition, installation of on-site heat networks to supply circa 27,000 apartments (96% of the total dwellings approved through planning) were also secured.

FIGURE 103: RENEWABLE FUELLED TRIGENERATION ENERGY CENTRE, KINGS YARD, OLYMPIC PARK, LONDON, UK



NOTES ON EMISSIONS REPORTED IN CASE STUDIES

Reductions in greenhouse gas emissions for renewable electricity have been based on the stated reduction in emissions of the state or country to which the case study relates with a further calculation of emissions based on the for New South Wales electricity grid emissions.

Reductions in greenhouse gas emissions for building scale and precinct scale technologies also take into account the avoided electricity grid emissions whereas utility scale technologies do not.

Reductions in greenhouse gas emissions for renewable gas technologies have been based on the New South Wales natural gas grid emissions since natural gas grid emissions are similar around the world.

Reductions in greenhouse gas emissions for renewable gases injected into the gas grid are the additional reductions in emissions through displacing natural gas supplying cogeneration/ trigeneration and exclude the reduction in emissions brought about by the original natural gas fired cogeneration/ trigeneration supplying electricity and thermal energy.

1 RENEWABLE ENERGY RESOURCES

2 RE-THINKING RENEWABLE ENERGY

3 RENEWABLE ENERGY FOR THE CITY OF SYDNEY

4 PERFORMANCE MEASURES

5 ENABLING THE MASTER PLAN

6 CASE STUDIES

TECHNICAL APPENDICES

Appendix 1 A Financial and Economic Analysis (The Allen Consulting Group)

Appendix 2 Renewable Gases Supply Infrastructure (Talent With Energy)

Appendix 3 Renewable Energy Master Plan Study (Arup)